



Business Message Standard (BMS) Common Library

BMS Release: 2.4.0, BRG Name: All

Issue 0.5.3, Sep-2007

Document Summary

Document Item	Current Value
Document Title	Business Message Standard (BMS)
BMS Name	Common Library
BMS Release	2.4.0
BRG Name	All
Document Number	Issue 0.5.3
Date Last Modified	Sep-2007
Status	Approved
Owner	All BRG
BMS Template Version	1.8

Document Change History

Date of Change	Version	Changed By	Reason for Change	Summary of Change	Model Build #
20041207	0.1.1	John Ryu	Maps to the GBM Structure. Ready for 1 st draft XML Development. Excludes Plan	Separated Common Library in chapter 3 (Common Components) and Chapter 4 (Process Common Components)	
20041209	0.1.2	John Ryu	Updates Finished Plan Common Library	Detail changes are provided in Summary of Changes Plan Common library section added in 4.7	4948
20041213	0.1.3.	John Ryu	Updated to common library	Detail changes are provided in Summary of Changes	MDL P4CL : 5055
20041213	0.1.4	John Ryu	Added Code Lists	Added code list into section 1.5.4 Detail changes are provided in Summary of Changes	MDL P4CL : 5094
20041216	0.1.5	John Ryu	Updated to the Code List	Detail changes are provided in Summary of Changes	
20041217	0.1.6	John Ryu	Update	Detail changes are provided in Summary of Changes	
20050218	0.1.7	John Ryu	Updates based on Order 2.0.1 work	Detail changes are provided in Summary of Changes	MDL P4CL :5774 BSD P4CL : 5781

Date of Change	Version	Changed By	Reason for Change	Summary of Change	Model Build #
20050228	0.1.8	John Ryu	Updates based on public review Order	Detail changes are provided in Summary of Changes	MDL P4CL : 5805 BSD P4CL : 5806
20050311	0.1.9	John Ryu	Based on 2.0.1 Plan work	Detail changes are provided in Summary of Changes	MDL P4CL : 6005 BSD P4CL :6006
20050329	0.1.10	Andrew Hearn	Update GDD Reports	GDD Reports were added to the document	BSD P4CL : 6189
20050331	0.1.11	John Ryu	Update GDD Reports	Expand Table of Content to include Class Diagram Section headers. Remove Data Type column from the GDD Report. Updated Order Common Definitions.	BSD P4CL : 6301
20050331	0.1.12	Eric Kauz	Update GDD Reports and Models	Trade Item Hazardous Information Abstract Description Short Description Abstract Amount	
20050407	0.1.13	John Ryu	Added creationDateTime : DateTime in the ResponseDocument class	Detail changes are provided in Summary of Changes 1.5.1.45 Related Requirements 1.5.2.45 GDD 1.5.3.1.5 Class Diagram	MDL P4CL : 6352 BSD P4CL : 6360
20050524	0.2.0	Coen Janssen	Several updates for Upstream Standards and ebMeat + Peer review comments	Detail changes are provided in Summary of Changes	
20050614	0.2.1	Coen Janssen	XML development comments	Added GoodsRequirementsLineItem Fixed some errors	
20050615	0.2.2	Eric Kauz	ebMeat Requirements	Added Extension Point to ItemContainmentClass	
20050616	0.2.3	Eric Kauz	Errata	Updated Data Types for MeasurementCode, PackageDescriptionCode Updated Quantity for change to MeasurementCode Date Type. Changed IncoTerm List to Internal Code List	
20050620	0.2.4	John Ryu	Change Name of CodeList	Based on FTL Load Tender F2F Lawrenceville Meeting DeliverPaymentMethodCodeList→1.5.4.70 TransportationPaymentMethodCodeList	BSD P4CL: 6931
20050708	0.2.5	John Ryu	Minor Typographical edits	Section 1.5.4.58 Service Level Code List Section 1.5.3.2.15 corrected typo in DeliverReference	BSD P4CL: 7097

Date of Change	Version	Changed By	Reason for Change	Summary of Change	Model Build #
20050711	0.2.6	Coen Janssen	Added new class QuantityRange	Needed for BMS Purchase Conditions	BSD P4CL: 7103
20050721	0.2.7	Coen Janssen	Technical Design Public Review	Functional changes, Detail changes are provided in Summary of Changes	
20050819	0.2.8	Coen Janssen	Technical Design Public Review	Functional changes, Detail changes are provided in Summary of Changes	
20050826	0.2.9	John Ryu	Technical Design Public Review	Detail changes are provided in Summary of Changes Added CurrencyExchangeRateInformation to Related Requirements/GDD/Class Diagram	MDL P4CL: 7363 BSD P4CL: 7365
20050913	0.2.10	Coen Janssen	Technical Design Public Review	Functional changes, Detail changes are provided in Summary of Changes	
20051003	0.2.11	Coen Janssen	TDPR Upstream Invoice	Functional changes to Payment Terms, Detail changes are provided in Summary of Changes	
20051014	0.2.12	John Ryu	Quality check against reintroduced elements from Document Version 0.2.0—0.2.11	Detail changes are provided in Summary of Changes	BSD P4CL: 7582 MDL P4CL: 7570
20051101	0.2.13	John Ryu	Work from Pay Advanced Remittance Notice	Detail changes are provided in Summary of Changes	BSD P4CL: 7648
20051115	0.2.14	Eric Kauz	Add FMCG Trade Item Identification	Detail changes are provided in Summary of Changes	BSD P4CL: 7648
20051202	0.2.15	John Ryu	Modified Message Reason List	Detail changes are provided in Summary of Changes	BSD P4CL: 7862
20060106	0.2.16	John Ryu	Modified Service Level code List	Detail changes are provided in Summary of Changes	BSD P4CL: 7969
20060206	0.2.17	Coen Janssen	Bugfix on version 2.1 (upstream)	Detail changes are provided in Summary of Changes Added new attribute	BSD P4CL: 8022
20060214	0.2.18	John Ryu	Based on Item Implementation Feedback Phase #1 work. BRAD p4cl: 7983	Marked targetMarketDescription for deprecation in the TargetMarketInformation.	BSD / MDL P4CL: 8074
20060301	0.2.19	John Ryu	Based on Transportation Rate Response and Reply work	Moved into Deliver Common. Commodity Group and Equipment Information	MDL P4CL: 8123 BSD P4CL: 8124

Date of Change	Version	Changed By	Reason for Change	Summary of Change	Model Build #
20060309	0.2.20	Esther Peelen	IRT Food & Beverage requirement	Added ExternalFileLink class	MDL P4CL: 8049
20060315	0.2.21	John Ryu	Based on Align Item Work	Changed flash point temperature from mandatory to optional. Detail changes are provided in Summary of Changes	MDL/BSD P4CL: 8183
20060321	0.2.21	Eric Kauz	IRT Food & Beverage requirement	Added UN_INFOODS_Code to Extended Data Types	CL 8213
20061205	0.2.22	John Ryu	Advanced Remittance Notification	Added Payment Discount	MDL 8311 BSD 8340
20060526	0.2.23	John Ryu	Updated For Major Release	Detail changes are provided in Summary of Changes	MDL: 8557 BSD: 8564
20070315	0.3.0	John Ryu	Update for BMS Release Version 2.1	Updates to GDD Platform	BSD P4CL: 9066
20070323	0.4.0	John Ryu	Updated for BMS Release Version 2.3		BSD P4CL: 9138
20070503	0.4.1	John Ryu	Update based on public review	Detail changes are provided in Summary of Changes	MDL P4CL: 9289 BSD P4CL: 9290
20070525	0.4.2	John Ryu	eCom BRG eballot approved	Updated BMS to approved	BSD p4cl: 9460
20070716	0.4.3	Giovanni Biffi and Brian Bennett	Updated the GDD report for the flashPointTemperature to make it optional as it is requested by GDSN MR2 Fixed spelling error on Model Event Tactic	Updates related to GDSN Maintenance Release 2 Quality Assurance	
20070717	0.5.0	John Ryu	Upgrade to BMS Release 2.4.0	Detail changes are provided in Summary of Changes.	MDL P4CL: 9617 BSD P4CL: 9668
20070802	0.5.1	John Ryu	Added VAT Tax Extension into common	Detail changes are provided in Summary of Changes.	MDL P4CL: 9701 BSD P4CL: 9702

Date of Change	Version	Changed By	Reason for Change	Summary of Change	Model Build #
20070904	0.5.2	John Ryu	Part of Stop Gap Report	Detail changes are provided in Summary of Changes.	MDL P4CL: 9910 BSD P4CL: 9913
20070925	0.5.3	John Ryu	Part of BMS Release 2.4.0	Updated BMS to approved	BSD P4CL: 10035

Disclaimer

Whilst every effort has been made to ensure that the guidelines to use the GS1 standards contained in the document are correct, GS1 and any other party involved in the creation of the document HEREBY STATE that the document is provided without warranty, either expressed or implied, of accuracy or fitness for purpose, AND HEREBY DISCLAIM any liability, direct or indirect, for damages or loss relating to the use of the document. The document may be modified, subject to developments in technology, changes to the standards, or new legal requirements. Several products and company names mentioned herein may be trademarks and/or registered trademarks of their respective companies.

Table of Contents

1. Business Solution Design	13
1.1. Problem Statement / Business Need	13
1.2. Objective.....	13
1.3. Audience.....	13
1.4. Artefacts	13
1.5. References	13
1.6. Acknowledgements	13
1.6.1. BRG Members.....	13
1.6.2. ITRG Members.....	14
1.6.3. Task/Project Group Participants (<i>where applicable</i>).....	14
1.6.4. Design Team Members	14
1.6.5. Business Context	14
2. Common Library Common Components	15
2.1. Package Overview: Common Library Common Components	15
2.2. Package Overview: Components	15
2.2.1. Class Diagram: Date and Time	16
2.2.2. GDD Report: Date and Time	16
2.2.3. Class Diagram: Dimension (Released for Next Major Publication).....	17
2.2.4. GDD Report: Dimension.....	17
2.2.5. Class Diagram: Document	18
2.2.6. GDD Report: Document	18
2.2.7. Class Diagram: Document Reference.....	20
2.2.8. GDD Report: Document Reference	20
2.2.9. Class Diagram: Range	22
2.2.10. GDD Report: Range	22
2.2.11. Class Diagram: Response Document	24
2.2.12. GDD Report: Response Document.....	24
2.3. Package Overview: Compound Data Type	26
2.3.1. Class Diagram Abstract Amount	26
2.3.2. GDD Report: Abstract Amount	26
2.3.3. Class Diagram: Abstract Description	27
2.3.4. GDD Report: Abstract Description	27
2.3.5. Class Diagram: Amount	27
2.3.6. GDD Report: Amount	27
2.3.7. Class Diagram: Code	28
2.3.8. GDD Report: Code	28
2.3.9. Class Diagram: Description.....	28
2.3.10. GDD Report: Description.....	29
2.3.11. Class Diagram: Description 2500.....	29
2.3.12. GDD Report: Description 2500.....	29

2.3.13.	Class Diagram: Description 5000.....	30
2.3.14.	GDD Report: Description 5000.....	30
2.3.15.	Class Diagram: Long Description.....	30
2.3.16.	GDD Report: Long Description.....	30
2.3.17.	Class Diagram: Measurement.....	31
2.3.18.	GDD Report: Measurement.....	31
2.3.19.	Class Diagram: Quantity	31
2.3.20.	GDD Report: Quantity	31
2.3.21.	Class Diagram: Short Description	32
2.3.22.	GDD Report: Short Description	32
2.4.	Package Overview: Data Type.....	33
2.4.1.	Class Diagram: Data Type	33
2.4.2.	GDD Report: Data Type	33
2.4.3.	Class Diagram: String Facet Data Type.....	34
2.4.4.	GDD Report: String Facet Data Type	34
2.5.	Package Overview: Extended Data Type	34
2.5.1.	Class Diagram: Extended Data Type.....	35
2.5.2.	GDD Report: Extended Data Type.....	35
2.6.	Package Overview: GS1 Physical Keys.....	36
2.7.	Package Overview: Identification	37
2.7.1.	Class Diagram: Entity Identification	37
2.7.2.	GDD Report: Entity Identification	38
2.7.3.	Class Diagram: FMCG Trade Item Identification	38
2.7.4.	GDD Report: FMCG Trade Item Identification	38
2.7.5.	Class Diagram: Party Identification	39
2.7.6.	GDD Report: Party Identification.....	39
2.7.7.	Class Diagram: Logistic Unit Identification.....	40
2.7.8.	GDD Report: Logistic Unit Identification.....	41
2.7.9.	Class Diagram: Trade Item Identification	42
2.7.10.	GDD Report: Trade Item Identification.....	42
2.7.11.	Class Diagram: Typed Entity Identification	43
2.7.12.	GDD: Typed Entity Identification	43
3.	Common Library Process Common Components	44
3.1.	Package Overview Common Library Process Components	44
3.2.	Package Overview: Catalogue Item Common	45
3.2.1.	Class Diagram: Catalogue Item Common.....	45
3.2.2.	GDD Report: Catalogue Item Common	45
3.3.	Package Overview: Deliver Common.....	47
3.3.1.	Class Diagram: Bill of Lading Collect on Delivery Information.....	47
3.3.2.	GDD Report: Bill of Lading Collect on Delivery Information.....	47
3.3.3.	Class Diagram: <<deprecate>> Bill of Lading Hazardous Information / Hazardous Shipment Information.....	48
3.3.4.	GDD Report: Bill of Lading Hazardous Information / Hazardous Shipment Information	48
3.3.5.	Class Diagram: Binary Signature Information.....	49

3.3.6.	GDD Report: Binary Signature Information.....	49
3.3.7.	Class Diagram: Carrier Identification	49
3.3.8.	GDD Report: Carrier Identification	50
3.3.9.	Class Diagram: Collect on Delivery Information.....	51
3.3.10.	GDD Report: Collect on Delivery Information	51
3.3.11.	Class Diagram: Commodity Classification Information	52
3.3.12.	GDD Report: Commodity Classification Information	52
3.3.13.	Class Diagram: Commodity Group	53
3.3.14.	GDD Report: Commodity Group	54
3.3.15.	Class Diagram: Deliver Date Information.....	55
3.3.16.	GDD Report: Deliver Date Information.....	55
3.3.17.	Class Diagram: <<Deprecate>> Deliver Location Information/ Location Information.....	56
3.3.18.	GDD Report: Deliver Location Information.....	56
3.3.19.	Class Diagram: Deliver Payment Method	57
3.3.20.	GDD Report: Deliver Payment Method	57
3.3.21.	Class Diagram: <<Deprecate>> Deliver Reference / Transportation Reference.....	58
3.3.22.	GDD Report: Deliver Reference / Transportation Reference.....	58
3.3.23.	Class Diagram: Deliver Shipment Information	59
3.3.24.	GDD Report: Deliver Shipment Information	59
3.3.25.	Class Diagram: Deliver Weight Information	60
3.3.26.	GDD Report: Deliver Weight Information	60
3.3.27.	Class Diagram: Despatch Information	61
3.3.28.	GDD Report: Despatch Information	62
3.3.30.	Class Diagram: Equipment Information	63
3.3.31.	GDD Report: Equipment Information	63
3.3.33.	Class Diagram: Freight Invoice Common	64
3.3.34.	GDD Report: Freight Invoice Common	65
3.3.35.	Class Diagram: Hazardous Shipment Information	67
3.3.36.	GDD Report: Hazardous Shipment Information.....	67
3.3.37.	Class Diagram: Interline Carrier	69
3.3.38.	GDD Report: Interline Carrier.....	69
3.3.39.	Class Diagram: Inventory Status Line Item.....	70
3.3.40.	GDD Report: Inventory Status Line Item.....	70
3.3.41.	Class Diagram: Item Containment	72
3.3.42.	GDD Report: Item Containment	72
3.3.43.	Class Diagram: Location Information	74
3.3.44.	GDD Report: Location Information.....	75
3.3.45.	Class Diagram: Logistic Unit Measurement.....	75
3.3.46.	GDD Report: Logistic Unit Measurement.....	76
3.3.47.	Class Diagram: Logistic Units	76
3.3.48.	GDD Report: Logistic Units	77
3.3.49.	Class Diagram: Package Dimension.....	78
3.3.50.	GDD Report: Deliver Package Dimension	79
3.3.51.	Class Diagram: Purchase Order Information	79

3.3.52.	GDD Report: Purchase Order Information	80
3.3.53.	Class Diagram: Shipment Seal Information	81
3.3.54.	GDD Report: Shipment Seal Information	81
3.3.55.	Class Diagram: Stop Location Information.....	82
3.3.56.	GDD Report: Stop Location Information	82
3.3.57.	Class Diagram: Transactional Item Data	83
3.3.58.	GDD Report: Transactional Item Data	84
3.3.59.	Class Diagram: Transportation Reference.....	86
3.3.60.	GDD Report: Transportation Reference.....	86
3.3.61.	Class Diagram: Unit Measurement	87
3.3.62.	GDD Report: Unit Measurement	87
3.4.	Package Overview: Global Search Common.....	88
3.5.	Process Common Components: Global Search Common.....	88
3.5.1.	Class Diagram: Party Search Result.....	88
3.5.2.	GDD Report: Party Search Result.....	88
3.5.3.	Class Diagram: Registry Catalogue Item Search Result	89
3.5.4.	GDD Report: Registry Catalogue Item Search Result	90
3.5.5.	Class Diagram: Trade Item Search Result.....	91
3.5.6.	GDD Report: Trade Item Search Result	91
3.6.	Package Overview: Order Common.....	92
3.6.1.	Class Diagram: Order Header Indicator	92
3.6.2.	GDD Report: Order Header Indicator.....	92
3.6.3.	Class Diagram: Order Logistical Information	93
3.6.4.	GDD Report: Order Logistical Information	94
3.6.5.	Class Diagram: Order Party Information	98
3.6.6.	GDD Report: Order Party Information	98
3.6.7.	Class Diagram: Simple Order Line Item.....	99
3.6.8.	GDD Report: Simple Order Line Item	99
3.6.9.	Class Diagram: Trade Agreement.....	100
3.6.10.	GDD Report: Trade Agreement.....	101
3.7.	Package Overview: Party Synchronisation Common.....	101
3.7.1.	Class Diagram: Party Capability.....	102
3.7.2.	GDD Report: Party Capability	102
3.8.	Package Overview: Pay Common.....	104
3.8.1.	Class Diagram: Adjustment Reason	104
3.8.2.	GDD Report: Adjustment Reason	104
3.8.3.	Class Diagram: Financial Institution Information.....	105
3.8.4.	GDD Report: Financial Institution Information.....	105
3.8.5.	Class Diagram: Invoice Allowance Charge	107
3.8.6.	GDD Report: Invoice Allowance Charge	107
3.8.7.	Class Diagram: Invoice Party	108
3.8.8.	GDD Report: Invoice Party.....	108
3.8.9.	Class Diagram: Invoice Tax Information	109
3.8.10.	GDD Report: Invoice Tax Information	109

3.8.11.	Class Diagram: Line Item Additional Identification.....	110
3.8.12.	GDD Report: Line Item Additional Identification.....	110
3.8.13.	Class Diagram: Line Item Packaging Information.....	111
3.8.14.	GDD Report: Line Item Packaging Information.....	111
3.8.15.	Class Diagram: Line Item Retail Information.....	112
3.8.16.	GDD: Line Item Retail Information	112
3.8.17.	Class Diagram: Pay Code.....	112
3.8.18.	GDD Report: Pay Code.....	113
3.8.19.	Class Diagram: Payment Discount.....	113
3.8.20.	GDD Report: Payment Discount	113
3.8.21.	Class Diagram: Payment Method.....	114
3.8.22.	GDD Report: Payment Method	114
3.8.23.	Class Diagram: VAT Invoice Party Extension.....	115
3.8.24.	GDD Report: VAT Invoice Party Extension.....	115
3.8.25.	Class Diagram: VAT Tax Information Extension.....	116
3.8.26.	GDD Report: VAT Tax Information Extension.....	116
3.9.	Package Overview: Plan Common.....	117
3.9.1.	Class Diagram: Bulk Common	117
3.9.2.	GDD Report: Bulk Common	118
3.9.3.	Class Diagram: Collaborative Trade Item	119
3.9.4.	GDD Report: Collaborative Trade Item	119
3.9.5.	Class Diagram: Event Tactic Type Code	120
3.9.6.	GDD Report: Event Tactic Type Code	120
3.9.7.	Class Diagram: Forecast and Forecast Revision Common	121
3.9.8.	GDD Report: Forecast and Forecast Revision Common.....	121
3.9.9.	Class Diagram: Goods Requirements Line Item.....	122
3.9.10.	GDD Report: Goods Requirements Line Item.....	122
3.9.11.	Class Diagram: Plan Document	123
3.9.12.	GDD Report: Plan Document.....	123
3.9.13.	Class Diagram: Quantity Specification.....	124
3.9.14.	GDD Report: Quantity Specification.....	124
3.9.15.	Class Diagram: Replenishment Common	125
3.9.16.	GDD Report: Replenishment Common.....	125
3.9.17.	Class Diagram: Time Series Data Item.....	126
3.9.18.	GDD Report: Time Series Data Item.....	126
3.10.	Package Overview: Price Common.....	127
3.10.1.	Class Diagram: Price Date	127
3.10.2.	GDD Report: Price Date.....	127
3.11.	Package Overview: Process Common.....	128
3.11.1.	Class Diagram: Contact	128
3.11.2.	GDD Report: Contact	128
3.11.3.	Class Diagram: Currency Exchange Rate Information	129
3.11.4.	GDD Report: Currency Exchange Rate Information	129
3.11.5.	Class Diagram: Name and Address.....	130

3.11.6.	GDD Report: Name and Address.....	131
3.11.7.	Class Diagram: Trade Item Hazardous Information.....	133
3.11.8.	GDD Report: Trade Item Hazardous Information.....	133
3.11.9.	Class Diagram: Shipment Transportation Information.....	135
3.11.10.	GDD Report: Shipment Transportation Information.....	135
3.11.11.	Class Diagram: External File Link.....	136
3.11.12.	GDD Report: External File Link.....	136
3.12.	Package Overview: Price Common.....	137
3.12.1.	Class Diagram: Response.....	137
3.12.2.	GDD Report: Response.....	137
3.13.	Package Overview: Terms.....	138
3.13.1.	Class Diagram: Allowance Charge.....	138
3.13.2.	GDD Report: Allowance Charge.....	139
3.13.3.	Class Diagram: Payment Terms.....	141
3.13.4.	GDD Report: Payment Terms.....	142
3.14.	Package Overview: Trade Item Common.....	144
3.15.	Package Overview: Trade Item Common.....	145
3.15.1.	Class Diagram: Out of Box Information.....	145
3.15.2.	GDD Report: Out of Box Information.....	145
3.15.3.	Class Diagram: Trade Item Entertainment.....	146
3.15.4.	GDD Report: Trade Item Entertainment.....	146
3.15.5.	Class Diagram: Target Market Information.....	148
3.15.6.	GDD Report: Target Market Information.....	149
3.15.7.	Class Diagram: Trade Item Price Date Information.....	150
3.15.8.	GDD Report: Trade Item Price Date Information.....	150
3.15.9.	Class Diagram: Warranty Information.....	151
3.15.10.	GDD Report: Warranty Information.....	152
4.	Summary of Changes.....	152

1. Business Solution Design

1.1. Problem Statement / Business Need

1.2. Objective

The objective to develop this common library is to enable the following.

- Contain and maintain all reusable data elements available in the GS1 BMS Standards.
- Standardize the design and development process to produce consistent and quality products.
- Aids and protects the integrity of the GBM
- Gives visibility to internal development staff and external users to our available reusable components.

1.3. Audience

The primary audience for this document are individuals assigned as GS1 Business Process Analysts, Business Requirements Groups Managers, GDD Managers, and XML System Developers who are responsible for the completion and delivery of the Business Message Standards.

The secondary audience for this document are users involved in the GSMP activities with BRG, ITRG, PTRG.

1.4. Artefacts

Artefact name	State	Artefact / State description
Not Applicable		

1.5. References

Reference Name	Description
GS1 Modeling Best Practices Version 0.6.0 for Publication 2.0	
Eb Methodology	

1.6. Acknowledgements

1.6.1. BRG Members

Function	Name	Company
None		

1.6.2. ITRG Members

Function	Name	Company / organisation
ITRG Chair	None	

1.6.3. Task/Project Group Participants (*where applicable*)

Function	Name	Company / organisation
Participant	None	

1.6.4. Design Team Members

Function	Name	Organisation
Modeller	John Ryu	GS1
XML Technical Designer		
GS1 Technical Designer		
Peer Reviewer		

1.6.5. Business Context

Context Category	Value(s)
Industry	All
Geopolitical	All
Product	All
Process	All
System Capabilities	All
Official Constraints	None

2. Common Library Common Components

2.1. Package Overview: Common Library Common Components

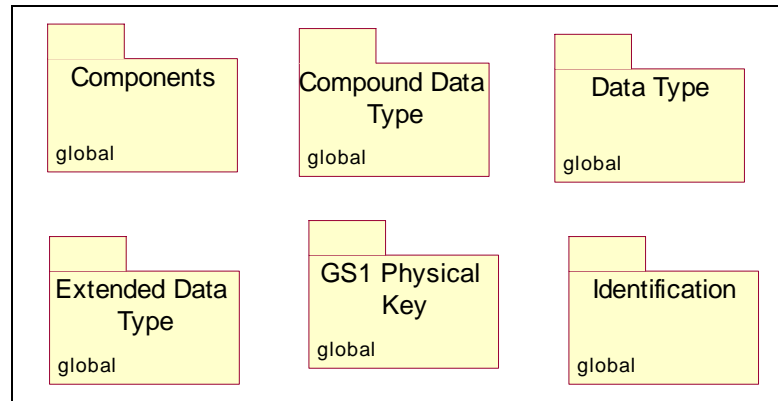

2.2. Package Overview: Components

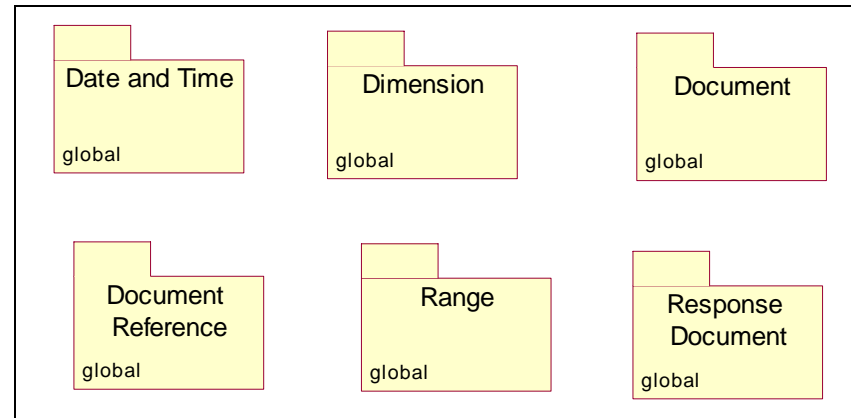

2.2.1. Class Diagram: Date and Time

Common Components: Components: Date and Time

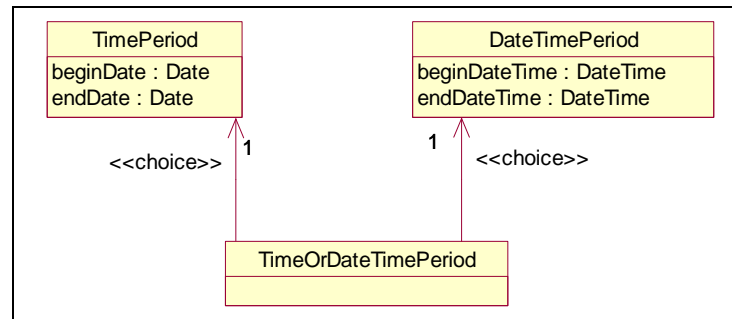

2.2.2. GDD Report: Date and Time

Class (ABIE)	Attribute (BBIE)	Association (ASBIE)	Secondary Class	Official Dictionary Entry Name	Definition	Multiplicity	Related Requirements
DateTimePeriod				Date Time_ Time Period. Details	Definition Not Found		
	beginDateTime			Date Time_ Time Period. Begin Date Time_ Date Time. Code	The date and time on which this event begins.	1..1	
	endDateTime			Date Time_ Time Period. End Date Time_ Date Time. Code	The date and time on which this event ends	1..1	
TimeOrDateTimePeriod				Time Or Date Time Period. Details	Allows for the selection of time period which only includes date or Date Time Period which includes both date and time.		
			DateTimePeriod	Time Or Date Time Period. Choice Association. Date Time_ Time Period	The time or date time period is represented in date time format.	1..1	
			TimePeriod	Time Or Date Time Period. Choice Association. Date_ Time Period	The time or date time period is represented in date format without time.	1..1	
TimePeriod				Date_ Time Period. Details	Definition Not Found		
	beginDate			Date_ Time Period. Begin Date. Code	The date and time on which this event begins	1..1	
	endDate			Date_ Time Period. End Date. Code	The date and time on which this event ends	1..1	

2.2.3. Class Diagram: Dimension (Released for Next Major Publication)

Common Components: Components: Dimension

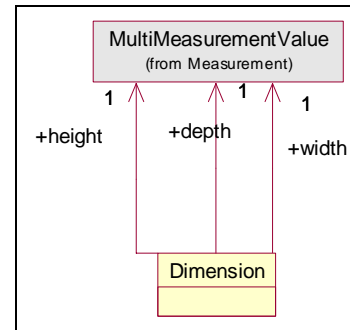

2.2.4. GDD Report: Dimension

Class (ABIE)	Attribute (BBIE)	Association (ASBIE)	Secondary Class	Official Dictionary Entry Name	Definition	Multiplicity	Related Requirements
Dimension				Dimension. Details	Provides the length, width, and depth of an item with their associated unit of measure. The unit of measure may be representend in multiple formats.		
		depth	MultiMeasurementValue	Dimension. Depth_ Association. Multi-unit Measure	The extent; measurement; or dimension downward; backward; or inward.	1..1	
		height	MultiMeasurementValue	Dimension. Height. Multi-unit Measure	The vertical dimension from the lowest extremity to the highest extremity.	1..1	
		width	MultiMeasurementValue	Dimension. Width. Multi-unit Measure	The measurement of the extent of something from side to side. Width is the measurement from left to right.	1..1	

2.2.5. Class Diagram: Document

Common Components: Components: Document

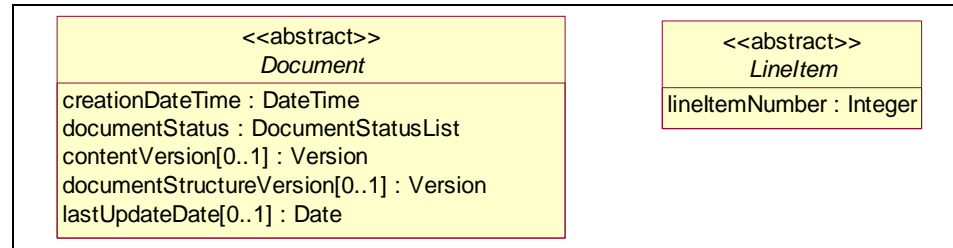

2.2.6. GDD Report: Document

Class (ABIE)	Attribute (BBIE)	Association (ASBIE)	Secondary Class	Official Dictionary Entry Name	Definition	Multiplicity	Related Requirements
Document				Electronic_Document.Details	Used to specify basic information about the content of the message including version number; creation date and time.		
	contentVersion			Electronic_Document.Content_Version.Identifier	This is a version number for the content of the document.	0..1	
	creationDateTime			Electronic_Document.Creation_Date.Identifier	This is the date the message was created. The format is 'YYYYMMDDTHHMMSS'. This date is recommended to use as technical information	1..1	
	documentStatus			Electronic_Document.Status.Identifier	Indicates if the document is a copy or an original.	1..1	
	documentStructureVersion			Electronic_Document.Document_Structure_Version.Identifier	This is a version number for the structure of the document.	0..1	

Class (ABIE)	Attribute (BBIE)	Association (ASBIE)	Secondary Class	Official Dictionary Entry Name	Definition	Multiplicity	Related Requirements
	lastUpdateDate			Electronic_Document.Last Update_Date.Identifier	This is the last update date for the specific document. The format is 'YYYY-MM-DD'.	0..1	
LineItem				Line Item. Details	This external class originates from Document.		
	lineItemNumber			Line Item. Number. Numeric	Sequence number that identifies the line.	1..1	

2.2.7. Class Diagram: Document Reference

Common Components: Components: Document Reference

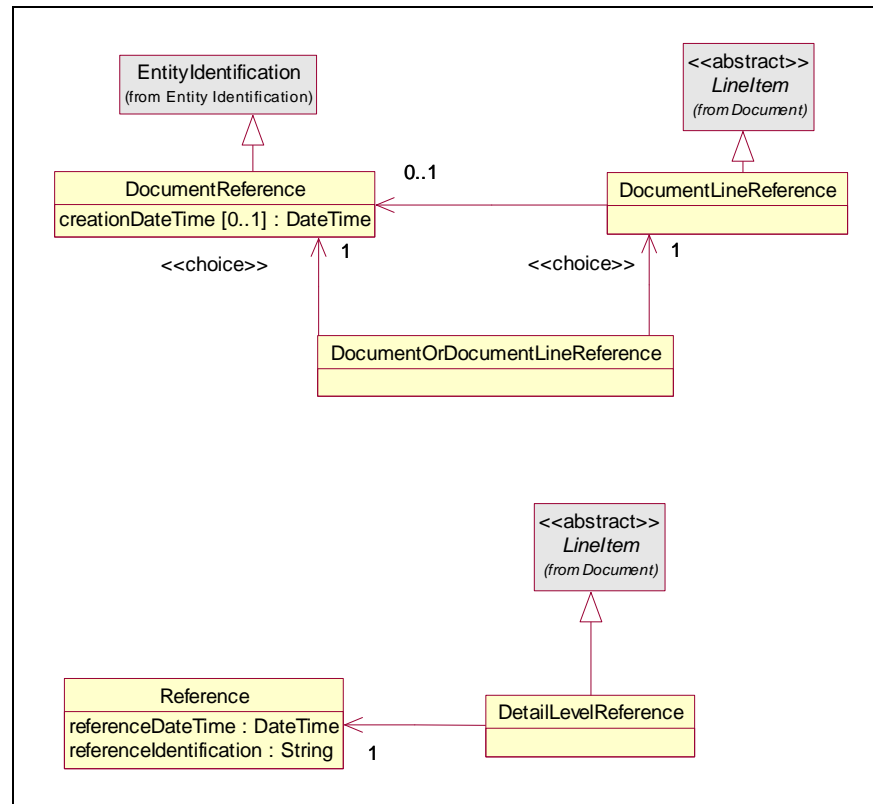

2.2.8. GDD Report: Document Reference

Class (ABIE)	Attribute (BBIE)	Association (ASBIE)	Secondary Class	Official Dictionary Entry Name	Definition	Multiplicity	Related Requirements
DetailLevelReference				Despatch Advice_Line Item_ Detail Level Reference. Details	This class was included to accommodate the requirement for identifying the reference document line number per despatch advice line number. It does this using it's associations with ItemContainment and its association with Reference.		

Class (ABIE)	Attribute (BBIE)	Association (ASBIE)	Secondary Class	Official Dictionary Entry Name	Definition	Multiplicity	Related Requirements
			Reference	Despatch Advice_Line Item_Detail Level Reference. Association. Entity Reference	This information on Reference for DetailLevelReference.	1..1	
DocumentLineReference				Document Line Reference. Details	Reference to another GS1 Business Message Line.		
			DocumentReference	Document Line Reference. Association. Document Reference	Identification of the business document to which the line belongs.	0..1	
			LineItem	Document Line Reference. Inheritance. Line Item	Identification of the referenced document line.	1..1	
DocumentOrDocumentLineReference				Document Or Document Line Reference. Details	Reference to another GS1 Business Message or Business Message Line.		
			DocumentLineReference	Document Or Document Line Reference. Choice_ Association. Document Line Reference	Provides the Document Line Reference information.	1..1	
			DocumentReference	Document Or Document Line Reference. Choice_ Association. Document Reference	Provides the Document Reference information.	1..1	
DocumentReference				Document Reference. Details	Reference to another GS1 Business Document.		
	creationDate Time			Document Reference. Creation_ Date Time. Date Time	Date and time of creation of the referenced document.	0..1	
			EntityIdentification	Document Reference. Association. Entity Identification	Identification of the referenced business document.	1..1	
Reference				Entity Reference. Details	Information with regards to a referenced document or message.		
	referenceDate Time			Entity Reference. Date. Code	The date; time or date time related to a referenced document or message.	1..1	
	referenceIdentification			Entity Reference. Identification. Code	Unique identification of the entity referenced.	1..1	

2.2.9. Class Diagram: Range

Common Components: Components: Range

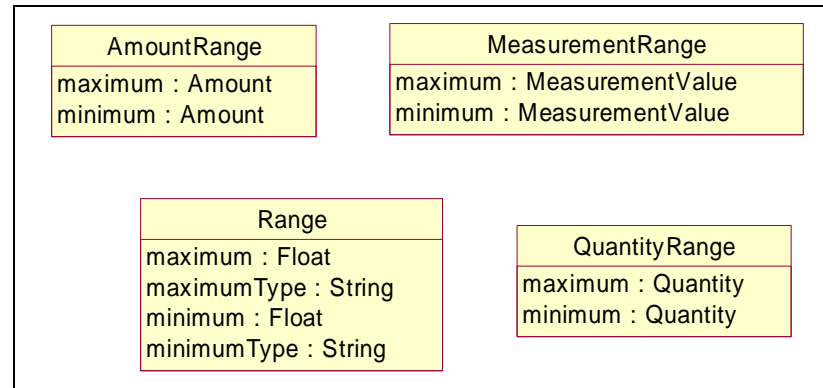

2.2.10. GDD Report: Range

Class (ABIE)	Attribute (BBIE)	Association (ASBIE)	Secondary Class	Official Dictionary Entry Name	Definition	Multiplicity	Related Requirements
AmountRange				Amount Range. Details	Provides the difference or interval between the minimum and maximum value amount including the associated currency.		
	maximum			Amount Range. Maximum Amount. Amount	Defines the upper limit required to qualify for the price amount. This attribute may occur multiple times within the same Price Bracket Identification to describe different range criteria. Bracket Range Minimum and/or Bracket Range Maximum is mandatory.	1..1	
	minimum			Amount Range. Minimum Amount. Amount	Defines the lower limit required to qualify for the price amount. This attribute may occur multiple times within the same Price Bracket Identification to describe different range criteria. Bracket Range Minimum and/or Bracket Range Maximum is mandatory.	1..1	
MeasurementRange				Measurement Range. Details	Provides the difference or interval between the minimum and maximum measurement including the associated unit of measure.		
	maximum			Measurement Range. Maximum Measure. Measure	Specifies the upper limit of the measurement range.	1..1	

Class (ABIE)	Attribute (BBIE)	Association (ASBIE)	Secondary Class	Official Dictionary Entry Name	Definition	Multiplicity	Related Requirements
	minimum			Measurement Range. Minimum Measure. Measure	Specifies the lower limit of the measurement range.	1..1	
QuantityRange				Quantity Range. Details	Provides the difference or interval between the minimum and maximum value which may include the associated unit of measure.		
	maximum			Quantity Range. Maximum. Quantity	Specifies the upper limit of the quantity range.	1..1	
	minimum			Quantity Range. Minimum. Quantity	Specifies the lower limit of the quantity range.	1..1	
Range				Range_ Range Group. Details	Provides the difference or interval between the minimum and maximum value.		
	maximum			Range_ Range Group. maximum_ value. Numeric	Specifies the upper limit of the quantity range.	1..1	
	maximumType			Range_ Range Group. maximum_ Type. Numeric	Identifies the type of measurement the range is expressed in.	1..1	
	minimum			Range_ Range Group. minimum_ value. Numeric	Specifies the lower limit of the quantity range.	1..1	
	minimumType			Range_ Range Group. minimum_ Type. Numeric	A code that identifies the unit of measure of the range lower limit.	1..1	

2.2.11. Class Diagram: Response Document

Common Components: Components: Response Document

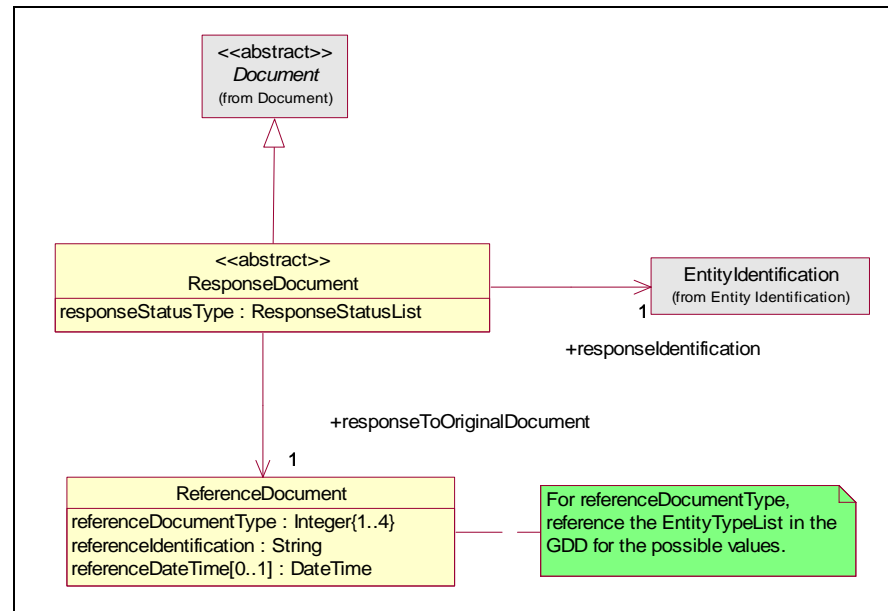

2.2.12. GDD Report: Response Document

Class (ABIE)	Attribute (BBIE)	Association (ASBIE)	Secondary Class	Definition	Multiplicity	Data Type Components	Related Requirements
ReferenceDocument				Contains the identification and date of the document referenced.			
	referenceDateTime			Provides the date and optional time for referenced document.	0..1	Date Time. Content Date Time. Format. Text	
	referenceDocumentType			Unique type of document referenced.	1..1	Numeric. Content Numeric. Format. Text	
	referenceIdentification			Unique identification of the document referenced.	1..1	Numeric. Content Numeric. Format. Text	

Class (ABIE)	Attribute (BBIE)	Association (ASBIE)	Secondary Class	Definition	Multiplicity	Data Type Components	Related Requirements
ResponseDocument				Specifies the type of response and the information of the referenced document.			
	responseStatusType			Unique type of response to a document referenced.	1..1	Code. Content Code List. Agency Identifier Code List. Agency Name. Text	
		None	Document	Identifies the document structure of the message.	1.1		BR# 3 BRAD Order Response Document and Reason Code Version 0.0.2
		responselidentification	EntityIdentification	The identification of the response document.	1..1		
		responseToOriginalDocument	ReferenceDocument	Contains the identification and date of the original document referenced.	1..1		

2.3. Package Overview: Compound Data Type

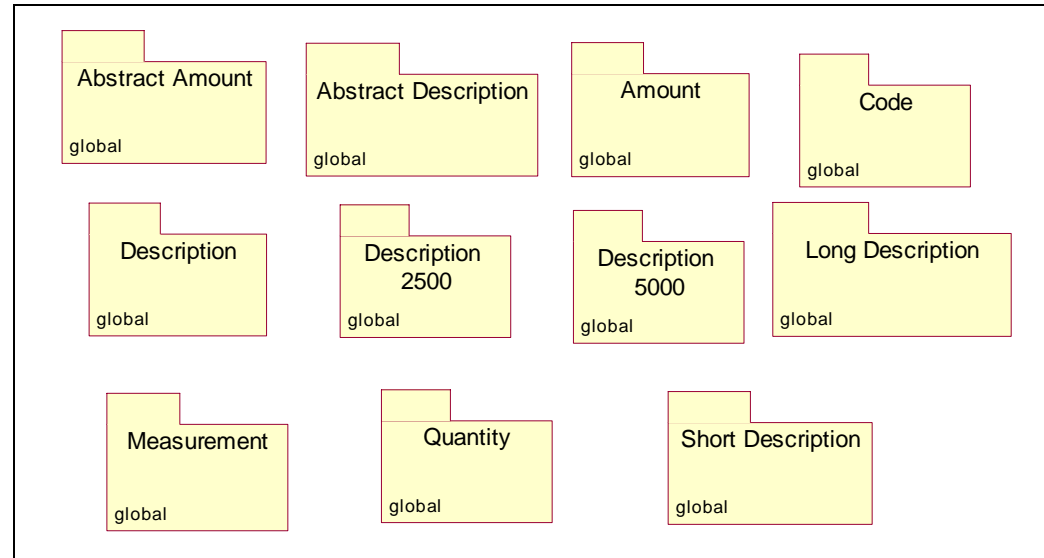

2.3.1. Class Diagram Abstract Amount

Common Components: Compound Data Type: Abstract Amount

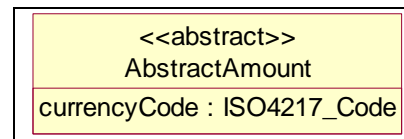

2.3.2. GDD Report: Abstract Amount

Class (ABIE)	Attribute (BBIE)	Association (ASBIE)	Secondary Class	Official Dictionary Entry Name	Definition	Multiplicity	Related Requirements
AbstractAmount				Abstract Amount. Details	n/a		
	currencyCode			Abstract Amount. Currency Code. ISO4217_ Code	N/A	1..1	

2.3.3. Class Diagram: Abstract Description

Common Components: Compound Data Type: Abstract Description

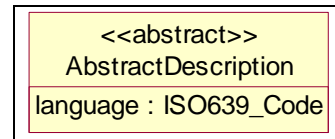

2.3.4. GDD Report: Abstract Description

Class (ABIE)	Attribute (BBIE)	Association (ASBIE)	Secondary Class	Official Dictionary Entry Name	Definition	Multiplicity	Related Requirements
AbstractDescription				Abstract Description. Details	na		
	language			Abstract Description. Language. ISO639_Code	n/a	1..1	

2.3.5. Class Diagram: Amount

Common Components: Compound Data Type: Amount

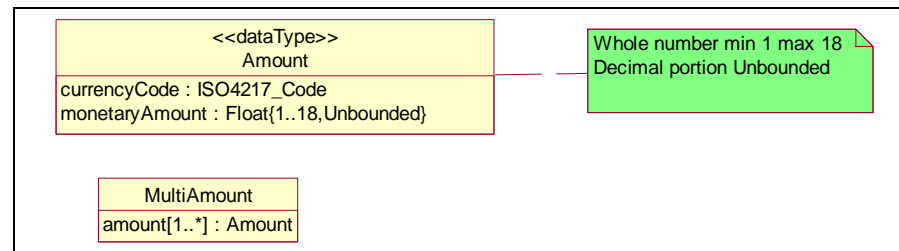

2.3.6. GDD Report: Amount

Class (ABIE)	Attribute (BBIE)	Association (ASBIE)	Secondary Class	Official Dictionary Entry Name	Definition	Multiplicity	Related Requirements
MultiAmount				Multi-currency Amount. Details	Provides multiple iterations of monetary amount and an associated currency code.		
	amount			Multi-currency Amount. Amount. Numeric	Quantity of money	1..*	

2.3.7. Class Diagram: Code

Common Components: Compound Data Type: Code

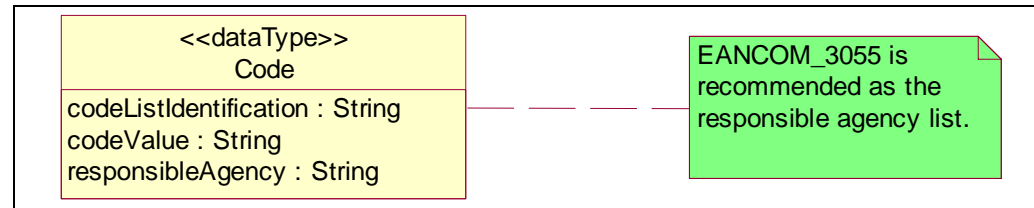

2.3.8. GDD Report: Code

Class (ABIE)	Attribute (BBIE)	Association (ASBIE)	Secondary Class	Official Dictionary Entry Name	Definition	Multiplicity	Related Requirements
Code				Code. Details	Provides the collection of the responsible code list agency; the code list identification; and the code value.		
	codeListIdentification			Code. List Identification_ code. Text{1..80}_ Text	Provides the identification of the referenced cost list.	1..1	
	codeValue			Code. Value_ code. Text{1..80}_ Text	Represents the code value associated with the code.	1..1	
	responsibleAgency			Code. List Agency_ code. Text{1..80}_ Text	Provides the responsible code list agency. EANCOM_3055 is recommended as the responsible agency list.	1..1	

2.3.9. Class Diagram: Description

Common Components: Compound Data Type: Description

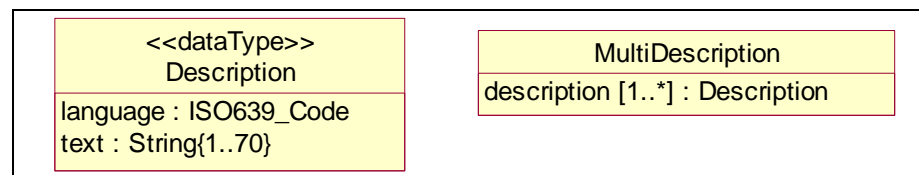

2.3.10. GDD Report: Description

Class (ABIE)	Attribute (BBIE)	Association (ASBIE)	Secondary Class	Official Dictionary Entry Name	Definition	Multiplicity	Related Requirements
MultiDescription				Multi Description. Details	Provides multiple iterations of descriptive text with a maximum length of 70 and an associated language code.		
	description			Multi Description. Description. Text	A systematic means of communicating by the use of sounds or conventional symbols.	1..*	

2.3.11. Class Diagram: Description 2500

Common Components: Compound Data Type: Description2500

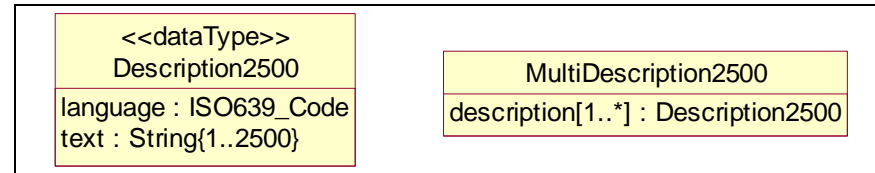

2.3.12. GDD Report: Description 2500

Class (ABIE)	Attribute (BBIE)	Association (ASBIE)	Secondary Class	Official Dictionary Entry Name	Definition	Multiplicity	Related Requirements
MultiDescription2500				Multi Description 2500. Details	Provides multiple iterations of descriptive text with a maximum length of 2500 and an associated language code.		
	description			Multi Description 2500. Description. Text	A systematic means of communicating by the use of sounds or conventional symbols.	1..*	

2.3.13. Class Diagram: Description 5000

Common Components: Compound Data Type: Description5000

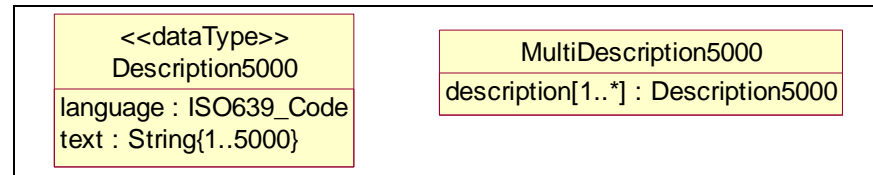

2.3.14. GDD Report: Description 5000

Class (ABIE)	Attribute (BBIE)	Association (ASBIE)	Secondary Class	Official Dictionary Entry Name	Definition	Multiplicity	Related Requirements
MultiDescription5000				Multi Description 5000. Details	Provides multiple iterations of descriptive text with a maximum length of 5000 and an associated language code.		
	description			Multi Description 5000. Description. Text	A systematic means of communicating by the use of sounds or conventional symbols.	1..*	

2.3.15. Class Diagram: Long Description

Common Components: Compound Data Type: Long Description

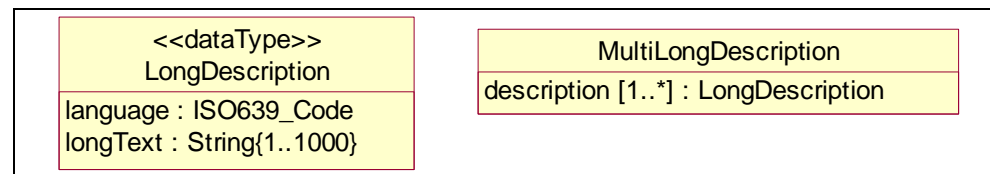

2.3.16. GDD Report: Long Description

Class (ABIE)	Attribute (BBIE)	Association (ASBIE)	Secondary Class	Official Dictionary Entry Name	Definition	Multiplicity	Related Requirements
MultiLongDescription				Multi Long Description. Details	Provides multiple iterations of descriptive text with a maximum length of 1000 and an associated language code.		
	description			Multi Long Description. Description. Text	A systematic means of communicating by the use of sounds or conventional symbols	1..*	

2.3.17. Class Diagram: Measurement

Common Components: Compound Data Type: Measurement

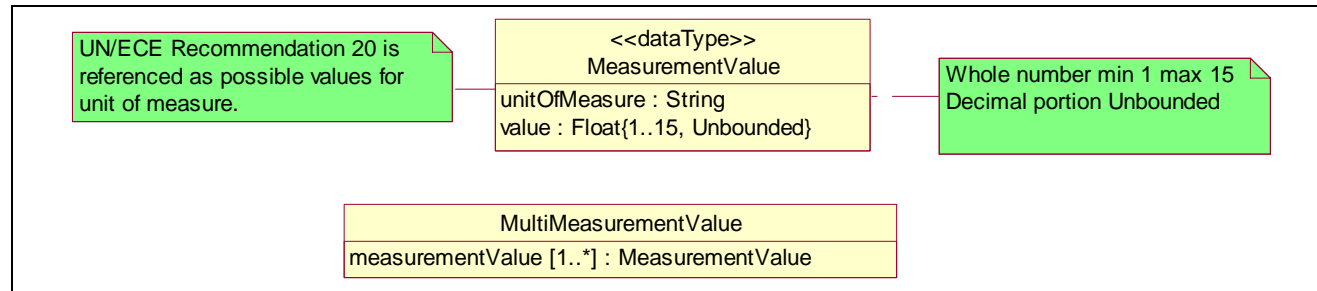

2.3.18. GDD Report: Measurement

Class (ABIE)	Attribute (BBIE)	Association (ASBIE)	Secondary Class	Official Dictionary Entry Name	Definition	Multiplicity	Related Requirements
MultiMeasurementValue				Multi Measurement Value. Details	Provides multiple iterations of measurement value and an associated unit of measure code.		
	measurementValue			Multi Measurement Value. Measurement Value. Measure	Provides the measurement value with the corresponding unit of measure.	1..*	

2.3.19. Class Diagram: Quantity

Common Components: Compound Data Type: Quantity

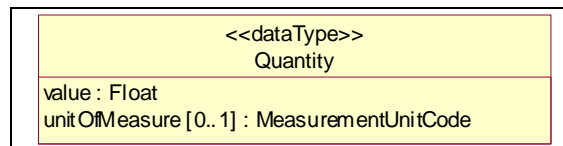

2.3.20. GDD Report: Quantity

No GDD report available for DataTypes.

2.3.21. Class Diagram: Short Description

Common Components: Compound Data Type: Short Description

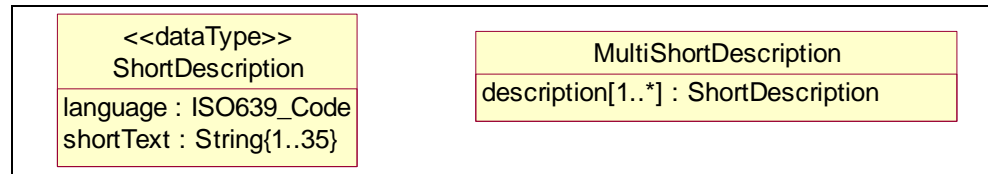

2.3.22. GDD Report: Short Description

Class (ABIE)	Attribute (BBIE)	Association (ASBIE)	Secondary Class	Official Dictionary Entry Name	Definition	Multiplicity	Related Requirements
MultiShortDescription				Short_ Multi-language Description. Details	Allows for the expression of text no greater than 35 characters in multiple languages.		
	description			Short_ Multi-language Description. Text	A systematic means of communicating by the use of sounds or conventional symbols.	1..*	

2.4. Package Overview: Data Type

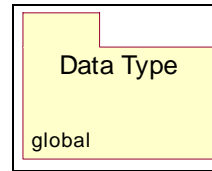

2.4.1. Class Diagram: Data Type

Common Components: Data Type

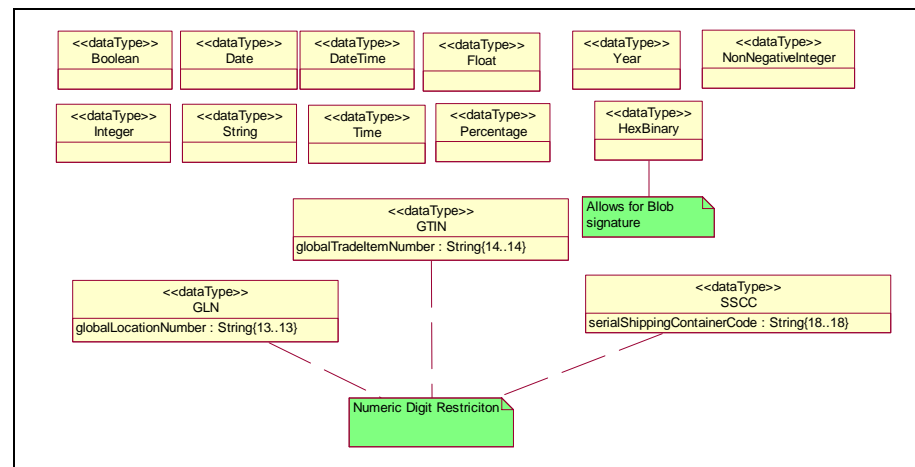

2.4.2. GDD Report: Data Type

GDD report for Data type is not applicable.

2.4.3. Class Diagram: String Facet Data Type

Common Components: Data Type: String Facets

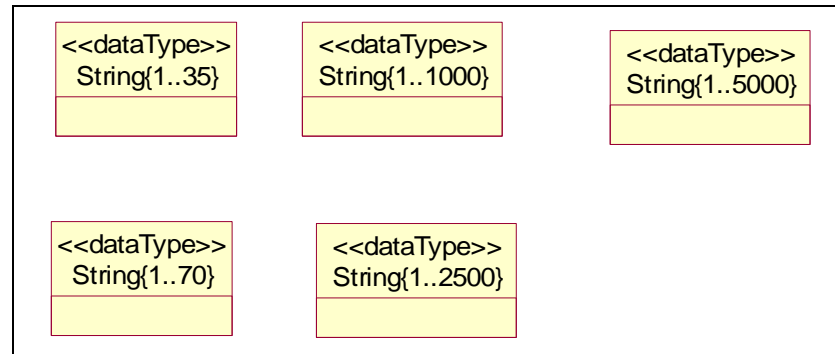

2.4.4. GDD Report: String Facet Data Type

GDD report for String Facet Data Type is not applicable.

2.5. Package Overview: Extended Data Type

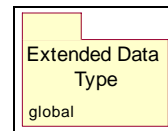

2.5.1. Class Diagram: Extended Data Type

Common Components: Extended Data Type

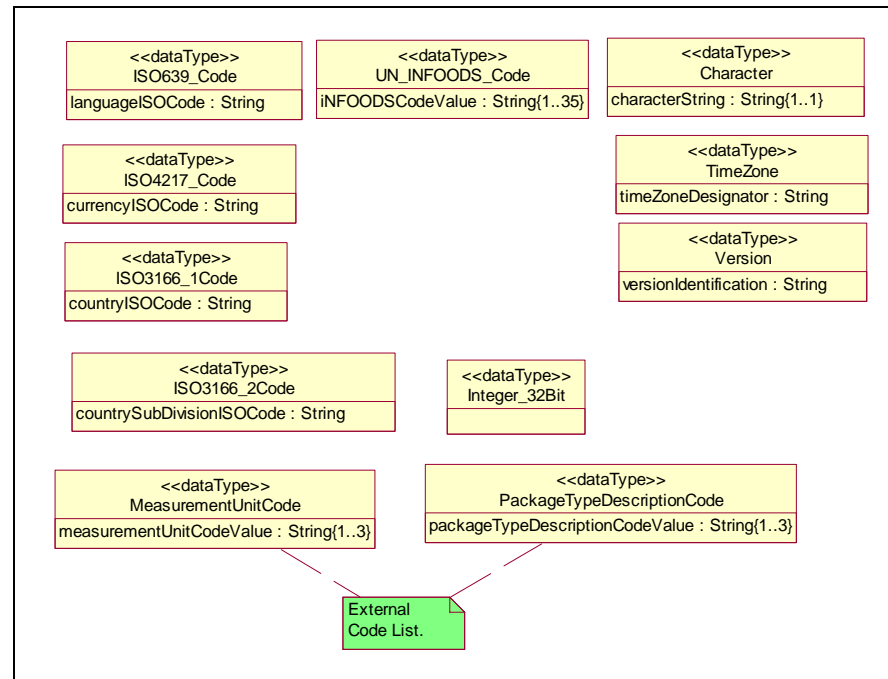

2.5.2. GDD Report: Extended Data Type

GDD report for Extended Data type is not applicable.

2.6. Package Overview: GS1 Physical Keys

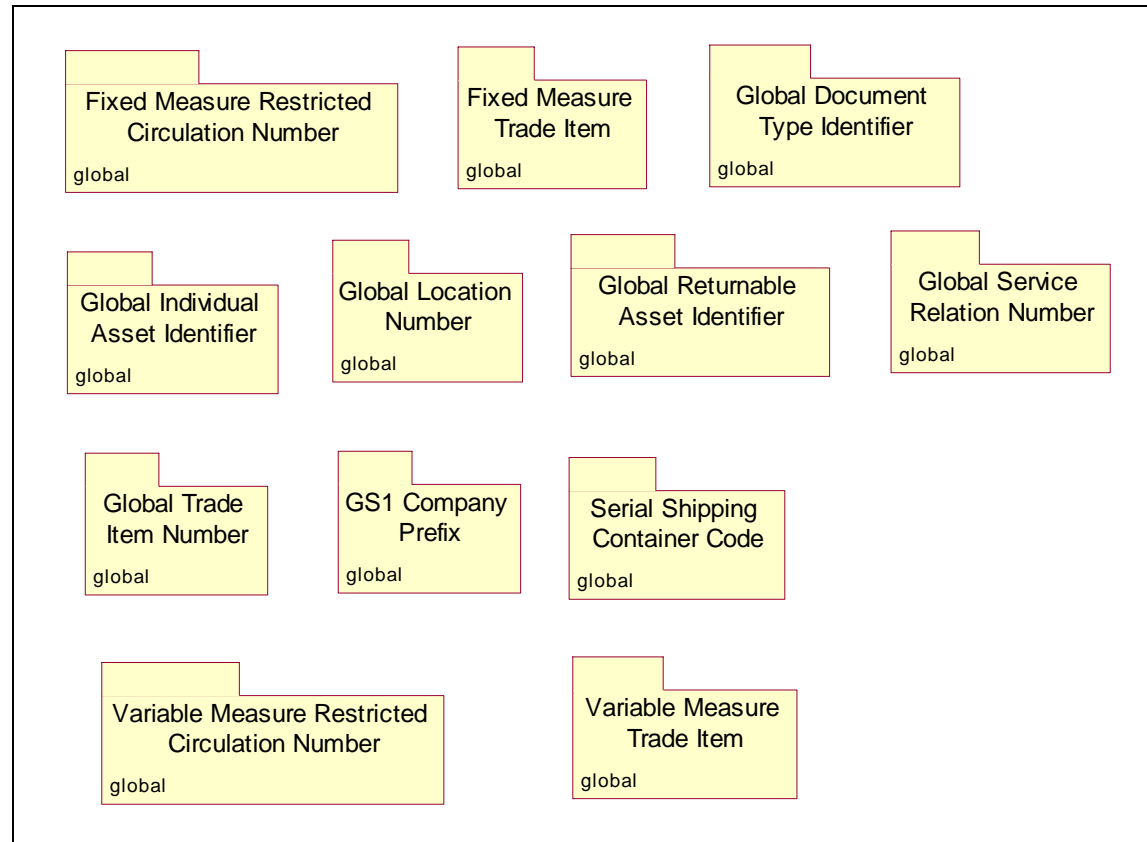

2.7. Package Overview: Identification

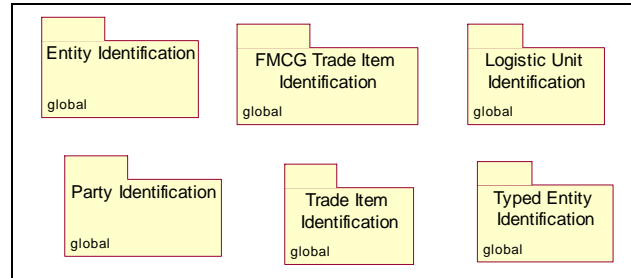

2.7.1. Class Diagram: Entity Identification

Common Components: Identification: Entity Identification

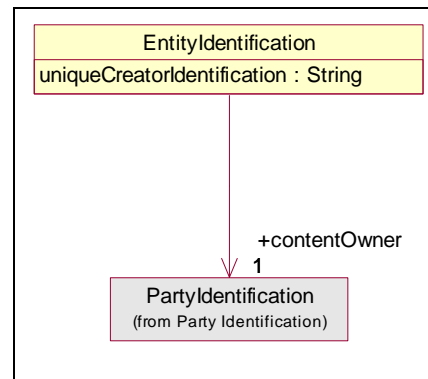

2.7.2. GDD Report: Entity Identification

Class (ABIE)	Attribute (BBIE)	Association (ASBIE)	Secondary Class	Official Dictionary Entry Name	Definition	Multiplicity	Related Requirements
EntityIdentification				Entity Identification. Details	The unique identification of a document.		
	uniqueCreatorIdentification			Entity Identification. Identification. Identifier	The unique creator identification for the message.	1..1	
		contentOwner	PartyIdentification	Entity Identification. Content Owner. Party Identification	Uniquely identifies the creator of the instance document.	1..1	

2.7.3. Class Diagram: FMCG Trade Item Identification

Common Components: Identification: FMCG Trade Item Identification

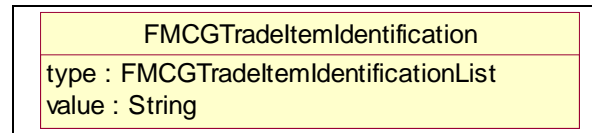

2.7.4. GDD Report: FMCG Trade Item Identification

Class (ABIE)	Attribute (BBIE)	Association (ASBIE)	Secondary Class	Official Dictionary Entry Name	Definition	Multiplicity	Related Requirements
FMCGTradeItemIdentification				Non GTIN_ FMCG_ Trade Item Identification. Details	This optional code will be used to cross-reference the Vendors internal trade item number to the GTIN in a one to one relationship.		
	type			Non GTIN_ FMCG_ Trade Item Identification. Identification Type. Code	Indicator identifying the type and format of the FMCG Additional Trade Item Identification Value	1..1	
	value			Non GTIN_ FMCG_ Trade Item Identification. Code	A trade item identifier, usually associated with a specific business need, that is in addition to the GTIN	1..1	

2.7.5. Class Diagram: Party Identification

Common Components: Identification: Party Identification

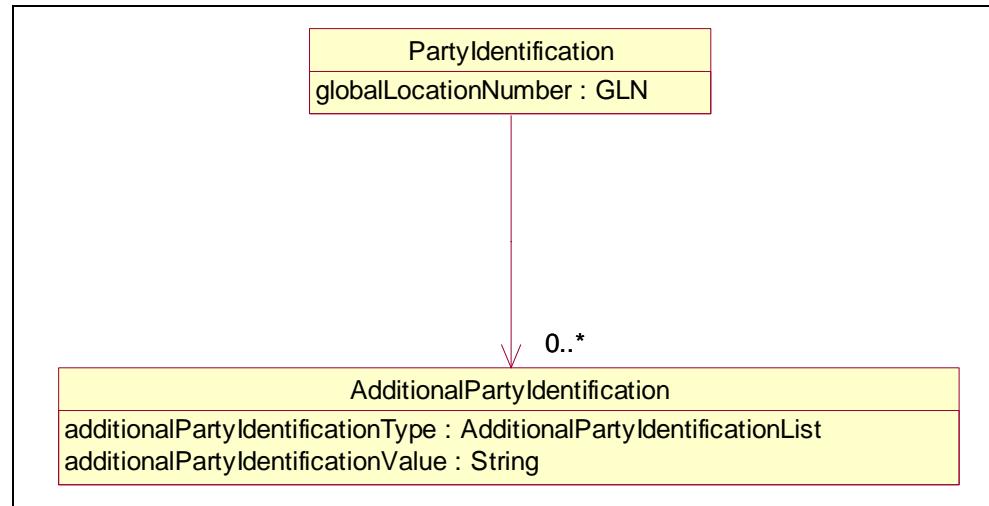

2.7.6. GDD Report: Party Identification

Class (ABIE)	Attribute (BBIE)	Association (ASBIE)	Secondary Class	Official Dictionary Entry Name	Definition	Multiplicity	Related Requirements
AdditionalPartyIdentification				Non GLN_ Party Identification. Details	Only one primary party identifier is used for each party. If an alternate identifier; other than GLN is used; there is no guarantee of data integrity across the process. It is the responsibility of the company electing the choice to ensure data integrity.		
	additionalPartyIdentificationType			Non GLN_ Party Identification. Identification Type. Code	Identification of a party by use of a code other than the Global Location Number.	1..1	
	additionalPartyIdentificationValue			Non GLN_ Party Identification. Code	A party identifier that is in addition to the GLN.	1..1	

Class (ABIE)	Attribute (BBIE)	Association (ASBIE)	Secondary Class	Official Dictionary Entry Name	Definition	Multiplicity	Related Requirements
PartyIdentification				Party Identification. Details	Unique location number identifying the Party for which the rest of the message defines.		
	globalLocationNumber			Party Identification. Primary_ Identification. GLN_ Identifier	The Global Location Number (GLN) is a structured identification of a physical location; legal or functional entity within an enterprise. The GLN is the primary party identifier. Each party identified in the trading relationship must have a primary party Identification.	1..1	
			AdditionalPartyIdentification	Party Identification. Additional. Non GLN_ Party Identification	Provides the optional additional formats of party identification	0..*	

2.7.7. Class Diagram: Logistic Unit Identification

Common Components: Identification: Logistic Unit Identification

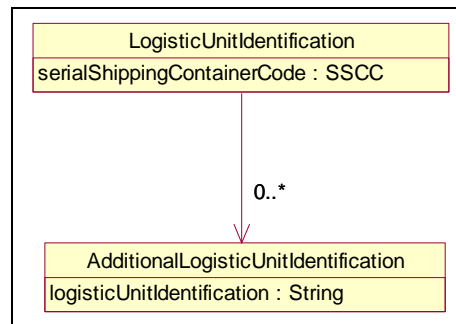

2.7.8. GDD Report: Logistic Unit Identification

Class (ABIE)	Attribute (BBIE)	Association (ASBIE)	Secondary Class	Official Dictionary Entry Name	Definition	Multiplicity	Related Requirements
AdditionalLogisticUnitIdentification				Additional Logistic Unit Identification. Details	Additional (non-SSCC) identification attached to a shipping container or shipping package and used for logistical and traceability purposes.		
	logisticUnitIdentification			Additional Logistic Unit Identification. Logistic Unit Identifier	A number which identifies shipping containers or shipping packages.	1..1	
LogisticUnitIdentification				Logistic Unit Identification. Details	The globally unique identification attached to a shipping container or shipping package and used for logistical and traceability purposes.		
	serialShippingContainerCode			Logistic Unit Identification. Serial Shipping Container Code. SSCC_Identifier	A single globally unique serial number which identifies shipping containers or shipping packages.	1..1	
			AdditionalLogisticUnitIdentification	Logistic Unit Identification. Association. Additional Logistic Unit Identification	Additional identification(s) attached to a shipping container or shipping package.	0..*	

2.7.9. Class Diagram: Trade Item Identification

Common Components: Identification: Trade Item Identification

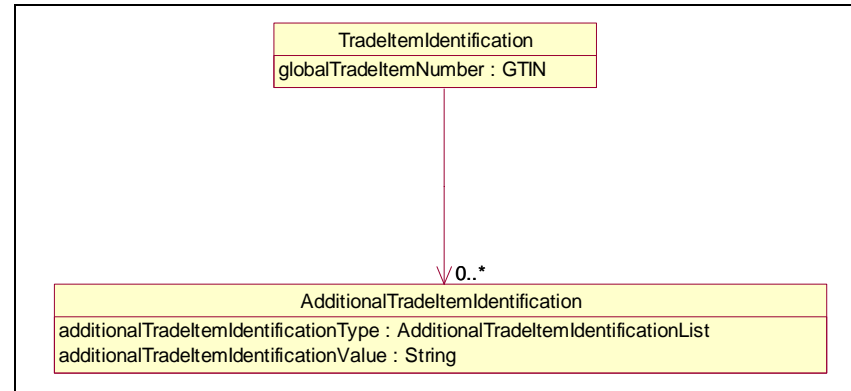

2.7.10. GDD Report: Trade Item Identification

Class (ABIE)	Attribute (BBIE)	Association (ASBIE)	Secondary Class	Official Dictionary Entry Name	Definition	Multiplicity	Related Documents
AdditionalTradeltemIdentification				Non GTIN_ Trade Item Identification. Details	This optional code will be used to cross-reference the Vendors internal trade item number to the GTIN in a one to one relationship.		
	additionalTradeltemIdentificationType			Non GTIN_ Trade Item Identification. Identification Type. Code	Type of the identification system that is being used as an alternative to the Global Trade Item Number.	1..1	
	additionalTradeltemIdentificationValue			Non GTIN_ Trade Item Identification. Additional Trade Item Identification Value_ additional Trade Item Identification. Code	Alternative means to the Global Trade Item Number to identify a trade item.	1..1	
TradeltemIdentification				Trade Item Identification. Details	Provides the GTIN as the unique identifier for the item and optionally additional formats of non GTIN identifiers for the item.		

Class (ABIE)	Attribute (BBIE)	Association (ASBIE)	Secondary Class	Official Dictionary Entry Name	Definition	Multiplicity	Related Documents
	globalTradeItemNumber			Trade Item Identification. Primary_ Identification. GTIN_ Identifier	A particular Global trade item Number; a numerical value used to uniquely identify a trade item. A trade item is any trade item (trade item or service) upon which there is a need to retrieve pre-defined information and that may be planned; priced; ordered; delivered and or invoiced at any point in any supply chain.	1..1	
			AdditionalTradeItemIdentification	Trade Item Identification. Additional. Non GTIN_ Trade Item Identification	This information on AdditionalTradeItemIdentification for TradeItemIdentification.	0..*	

2.7.11. Class Diagram: Typed Entity Identification

Common Components: Identification: Typed Entity Identification

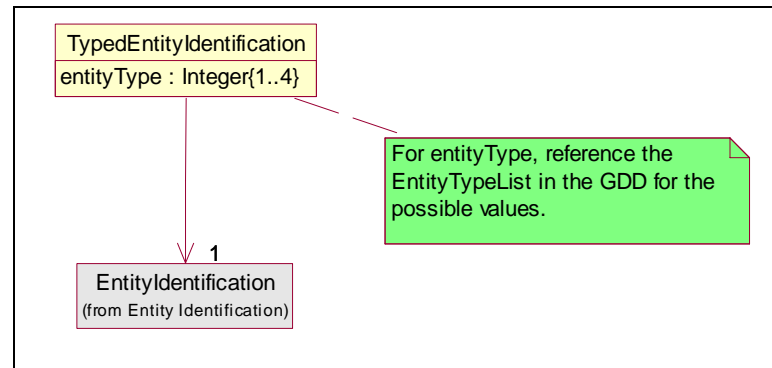

2.7.12. GDD: Typed Entity Identification

Class (ABIE)	Attribute (BBIE)	Association (ASBIE)	Secondary Class	Official Dictionary Entry Name	Definition	Multiplicity	Related Requirements
TypedEntityIdentification				Typed_ Entity Reference. Details	Identifies the type of document and provide a unique identifier.		
	entityType			Typed_ Entity Reference. Entity Type. Code	Identifies, from a pre-defined list; the class of document that is referenced.	1..1	
			EntityIdentification	Typed_ Entity Reference. Association. Entity Identification	This information on EntityIdentification for TypedEntityIdentification.	1..1	

3. Common Library Process Common Components

3.1. Package Overview Common Library Process Components

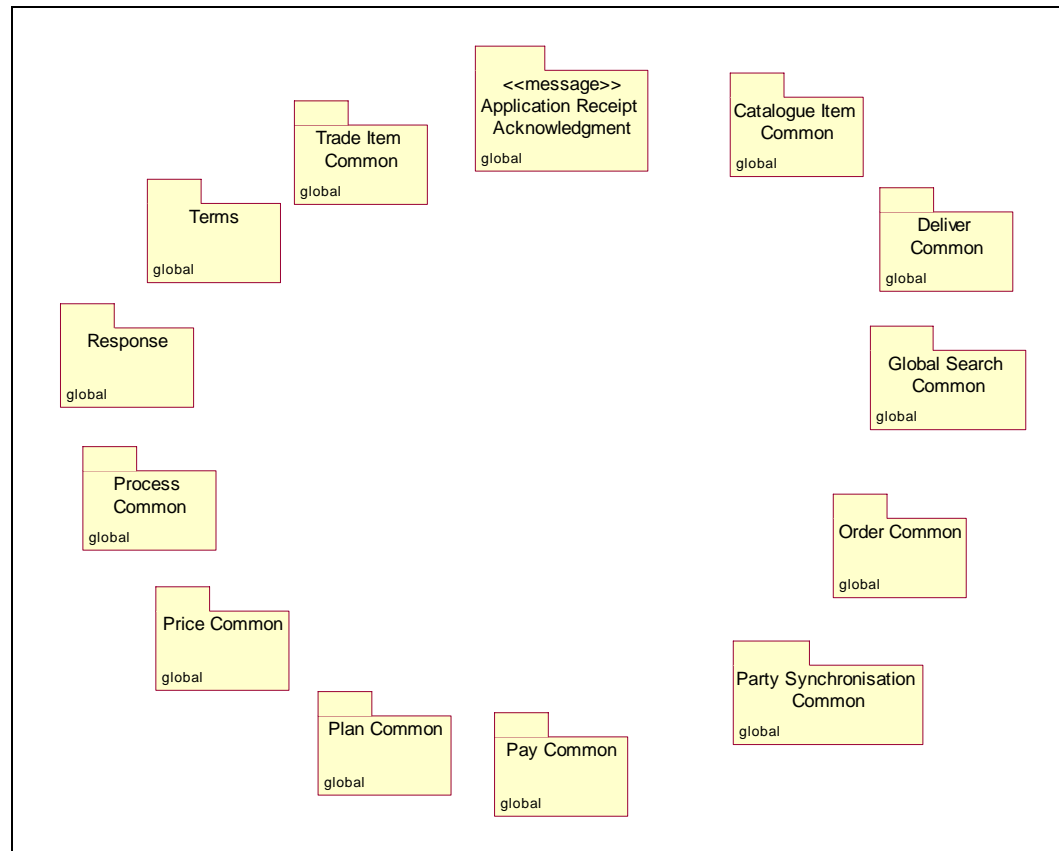

3.2. Package Overview: Catalogue Item Common

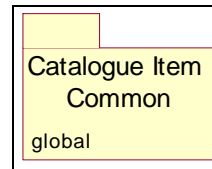

3.2.1. Class Diagram: Catalogue Item Common

Process Common Components: Catalogue Item Common

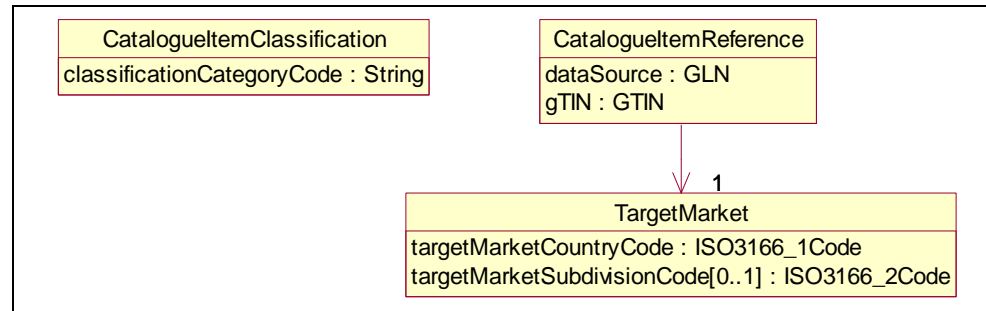

3.2.2. GDD Report: Catalogue Item Common

Class (ABIE)	Attribute (BBIE)	Association (ASBIE)	Secondary Class	Official Dictionary Entry Name	Definition	Multiplicity	Related Requirements
CatalogueItemClassification				GPC_Product Classification. Details	A classification schema is an Industry accepted, standardized method to group like products together so that global searches can be enabled.		
	classificationCategoryCode			GPC_Product Classification. Class. Text	A code that identifies a category in the GPC product classification	1..1	
CatalogueItemReference				Catalogue Item Identification. Details	A class of information used to identify the key to the trade item information using the data source GLN; the GTIN; and the Target Market within the Global Data Synchronisation Network.		

Class (ABIE)	Attribute (BBIE)	Association (ASBIE)	Secondary Class	Official Dictionary Entry Name	Definition	Multiplicity	Related Requirements
	dataSource			Catalogue Item Identification. Data Source_ Party. GLN_ Identifier	Entity that provides the global data synchronization network with Master Data. The Data Source is officially recognized as the owner of this data. For a given Item or Party; the source of data is responsible for permanent updates of the information under its responsibility.	1..1	
	gTIN			Catalogue Item Identification. GTIN_ Identification. GTIN_ Identifier	A particular Global trade item Number; a numerical value used to uniquely identify a trade item. A trade item is any trade item (trade item or service) upon which there is a need to retrieve pre-defined information and that may be planned; priced; ordered; delivered and or invoiced at any point in any supply chain.	1..1	
			TargetMarket	Catalogue Item Identification. Association. Target Market	Provides the target market information.	1..1	
TargetMarket				Target Market. Details	The Target Market is a geographical region based upon geographical boundaries sanctioned by the United Nations. There is one international system to describe geographical regions; the ISO-3166-code system.		
	targetMarketCountryCode			Target Market. Market Country. Code	The code that identifies the target market. The target market is at country level or higher geographical definition and is where a trade-item is intended to be sold.	1..1	
	targetMarketSubdivisionCode			Target Market. Market Subdivision. Code	The Code for country sub-division definition used to indicate the geopolitical subdivision of the target market (=country).	0..1	

3.3. Package Overview: Deliver Common

3.3.1. Class Diagram: Bill of Lading Collect on Delivery Information

Process Common Components: Deliver Common: Bill Of Lading Collect On Delivery Information

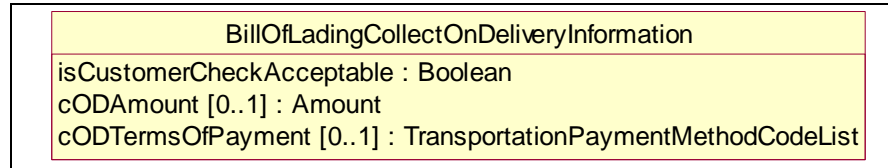

3.3.2. GDD Report: Bill of Lading Collect on Delivery Information

Class (ABIE)	Attribute (BBIE)	Association (ASBIE)	Secondary Class	Official Dictionary Entry Name	Definition	Multiplicity	Related Requirements
BillOfLadingCollectOnDeliveryInformation				Bill Of Lading_ Collect On Delivery. Details	Provides the Collect on Delivery information regarding the shipment.		
	cODAmount			Bill Of Lading_ Collect On Delivery. Collect On Delivery_ Amount. Code	Cash on delivery fee amount. Includes Currency	0..1	
	cODTermsOfPayment			Bill Of Lading_ Collect On Delivery. Collect On Delivery_ Terms Of Payment_ Type. Code	Identifies which party is responsible for paying the fee to collect the COD amount.	0..1	
	isCustomerCheckAcceptable			Bill Of Lading_ Collect On Delivery. Customer_ Check_ Acceptable. Code	Can the driver receive a check for payment of the COD fee (yes/no).	1..1	

3.3.3. Class Diagram: <<deprecate>> Bill of Lading Hazardous Information / Hazardous Shipment Information

Process Common Components: Deliver Common: Bill of Lading Hazardous Information

Note: Reference Hazardous Shipment Information GDD as Bill of Lading Hazardous is marked for deprecation

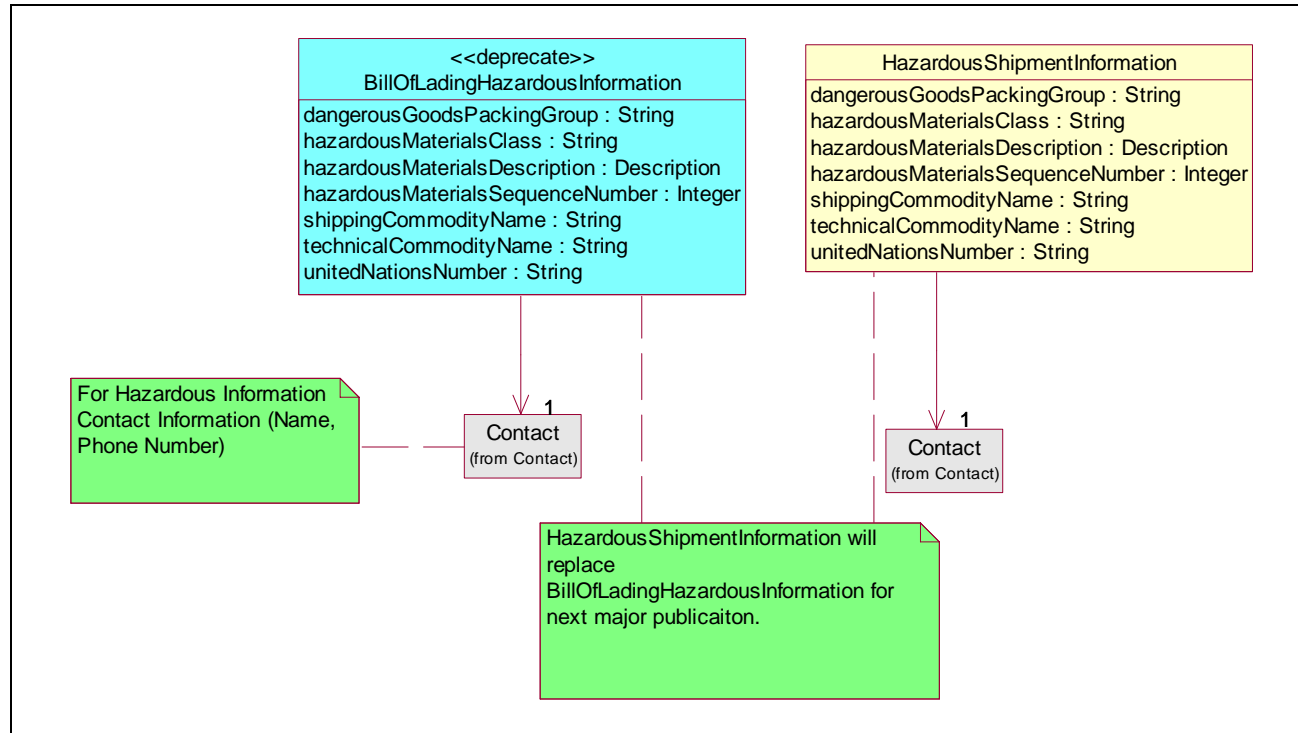

3.3.4. GDD Report: Bill of Lading Hazardous Information / Hazardous Shipment Information

Note: No GDD Report for Bill of Lading Hazardous Information reference Hazardous Shipment Information

3.3.5. Class Diagram: Binary Signature Information

Process Common Components: Deliver Common: Binary Signature Information

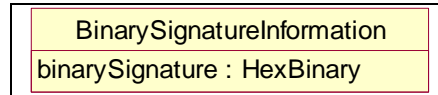

3.3.6. GDD Report: Binary Signature Information

Class (ABIE)	Attribute (BBIE)	Association (ASBIE)	Secondary Class	Official Dictionary Entry Name	Definition	Multiplicity	Related Requirements
BinarySignatureInformation				Binary_ Signature. Details	Provides the binary expression of a signature.		
	binarySignature			Binary_ Signature. Binary Signature. Text	When referencing the status of an SPC shipment that was electronically signed off; this is the binary expression of this signature.	1..1	

3.3.7. Class Diagram: Carrier Identification

Process Common Components: Deliver Common: Carrier Identification

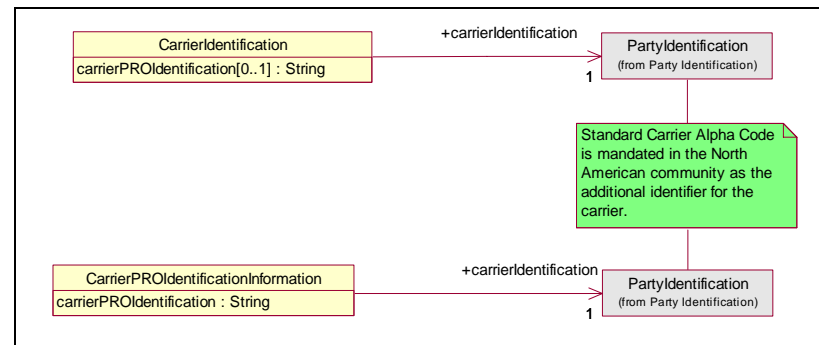

3.3.8. GDD Report: Carrier Identification

Class (ABIE)	Attribute (BBIE)	Association (ASBIE)	Secondary Class	Official Dictionary Entry Name	Definition	Multiplicity	Related Requirements
CarrierIdentification				Carrier_ Shipment Identification. Details	Provides the carrier identification and the optional carrier PRO Identification.		
	carrierPROIdentification			Carrier_ Shipment Identification. Carrier Pro Identification. Indicator	Number assigned by the shipper to identify the shipment. This is usually the Bill Of Lading Number. This number may not be unique in the carrier's internal system.	0..1	
		carrierIdentification	PartyIdentification	Carrier_ Shipment Identification. Carrier Identifier. Party Identification	Unique identifier for the company which physically transports goods from one place to another.	1..1	
CarrierPROIdentificationInformation				Carrier PRO_ Shipment Identification. Details	Provides the carrier identification and the carrier PRO Identification.		
	carrierPROIdentification			Carrier PRO_ Shipment Identification. Carrier Pro Identification. Indicator	Number assigned by the shipper to identify the shipment. This is usually the Bill Of Lading Number. This number may not be unique in the carrier's internal system.	1..1	
		carrierIdentification	PartyIdentification	Carrier PRO_ Shipment Identification. Carrier Identifier. Party Identification	Unique identifier for the company which physically transports goods from one place to another.	1..1	

3.3.9. Class Diagram: Collect on Delivery Information

Process Common Components: Deliver Common: Collect on Delivery Information

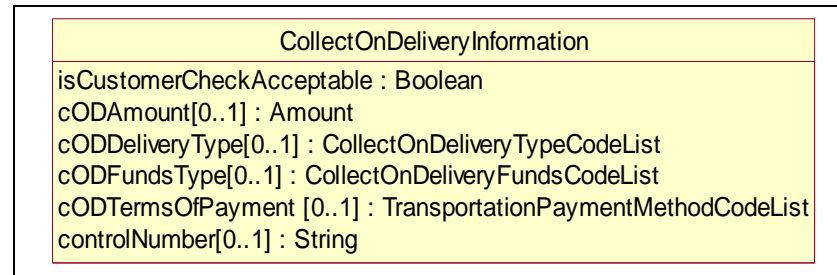

3.3.10. GDD Report: Collect on Delivery Information

Class (ABIE)	Attribute (BBIE)	Association (ASBIE)	Secondary Class	Official Dictionary Entry Name	Definition	Multiplicity	Related Requirements
CollectOnDeliveryInformation				Collect On Delivery_Payment. Details	Provides the collect on delivery information.		
	cODAmount			Collect On Delivery_Payment. Collect On Delivery_Amount. Code	Cash on delivery fee amount. Includes Currency.	0..1	
	cODDeliveryType			Collect On Delivery_Payment. Collect On Delivery_Type. Code	The type of collect on delivery. This can either be regular or tagless.	0..1	
	cODFundsType			Collect On Delivery_Payment. Funds_Type. Code	The currency for the payment of Collect on Delivery. This refers to an externally maintained ISO Codelist	0..1	
	cODTermsOfPayment			Collect On Delivery_Payment. Deliver Payment Method_Type. Code	Identifies which party is responsible for paying the fee to collect the COD amount.	0..1	
	controlNumber			Collect On Delivery_Payment. Control_Number. Code	Number assigned by the government to contract the movement of shipments.	0..1	
	isCustomerCheckAcceptable			Collect On Delivery_Payment. Customer_Check Acceptable. Code	Can the driver receive a check for payment of the COD fee (yes/no).	1..1	

3.3.11. Class Diagram: Commodity Classification Information

Process Common Components: Deliver Common: Commodity Classification Information

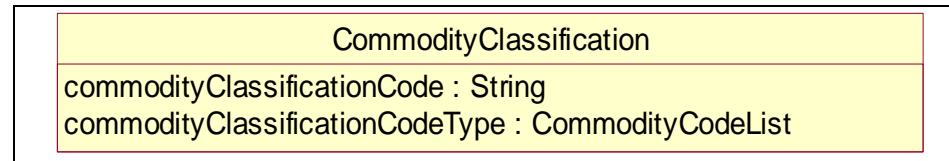

3.3.12. GDD Report: Commodity Classification Information

Class (ABIE)	Attribute (BBIE)	Association (ASBIE)	Secondary Class	Official Dictionary Entry Name	Definition	Multiplicity	Related Requirements
CommodityClassification				Commodity Classification. Details	Provides the commodity classification code and commodity classification type.		
	commodityClassificationCode			Commodity Classification. Commodity Classification_ Code. Code	Code specifying the type of product being shipped. National Motor Freight Classification code is required in North America.	1..1	
	commodityClassificationCodeType			Commodity Classification. Commodity Classification_ Code Type. Code	Code specifying the type of product being shipped.	1..1	

3.3.13. Class Diagram: Commodity Group

Process Common Components: Deliver Common: Commodity Group

20060301 the work from FTL Load Tender changed from OLD to New. moved into common as reused in FTL Load Tender and now Transportation Rate Simple Request

Old

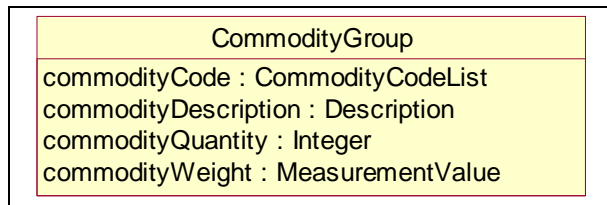

New

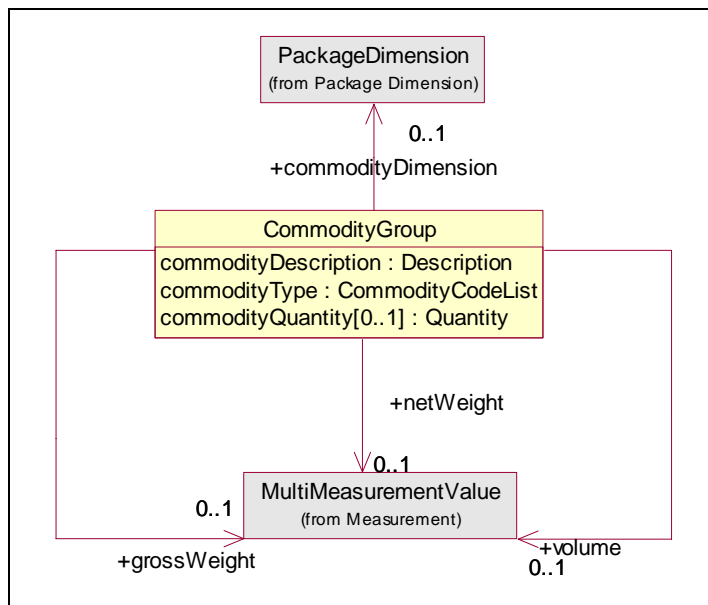

3.3.14. GDD Report: Commodity Group

Class (ABIE)	Attribute (BBIE)	Association (ASBIE)	Secondary Class	Official Dictionary Entry Name	Definition	Multiplicity	Related Requirements
CommodityGroup				Commodity Group. Details	Commodity Group provides the commodity description; commodity type; commodity weight; and the commodity quantity.		
	commodityDescription			Commodity Group. Commodity Description_ Description. Text	Description of an item as required for rating and billing purposes and customer inventory control expectations.	1..1	
	commodityQuantity			Commodity Group. Commodity Quantity_ Quantity. Quantity	The numeric value of the quantity of the commodity and the optional unit of measure.	0..1	
	commodityType			Commodity Group. Commodity Type_ Code. Commodity_ Code	Code describing a commodity or group of commodities.	1..1	
		grossWeight	MultiMeasurementValue	Commodity Group. Gross Weight_ Association. Multi-unit Measure	The numeric value of gross weight of the commodity and the associated unit of measure. Gross weight is defined as weight or mass of goods including packaging; but excluding the carrier's equipment. This value may be converted into multi measurement formats.	0..1	
		netWeight	MultiMeasurementValue	Commodity Group. Net Weight_ Association. Multi-unit Measure	The numeric value of net weight of the commodity and the associated unit of measure. This value may be converted into multi measurement formats.	0..1	
		volume	MultiMeasurementValue	Commodity Group. Volume_ Association. Multi-unit Measure	The numeric value of volume of the commodity and the associated unit of measure. It is a volumetric measurement. This value may be converted into multi measurement formats.	0..1	
		commodityDimension	PackageDimension	Commodity Group. Commodity Dimension_ Association. Package Dimension	Provides the length; width; and height of a commodity with their associated unit of measure. The unit of measure may be represented in multiple formats.	0..1	

3.3.15. Class Diagram: Deliver Date Information

Process Common Components: Deliver Common: Deliver Date Information

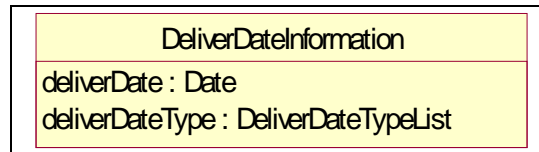

3.3.16. GDD Report: Deliver Date Information

Class (ABIE)	Attribute (BBIE)	Association (ASBIE)	Secondary Class	Official Dictionary Entry Name	Definition	Multiplicity	Related Requirements
DeliverDateInformation				Deliver_ Date. Details	Provides the date information for the shipment.		
	deliverDate			Deliver_ Date. Delivery Date. Code	The date on which the shipment is delivered	1..1	
	deliverDateType			Deliver_ Date. Delivery Date_ Type. Code	A code identifying the type of date on which goods or services will or have been delivered.	1..1	

3.3.17. Class Diagram: <<Deprecate>> Deliver Location Information/ Location Information

Process Common Components: Deliver Common: Deliver Location Information

Note: Reference Location Information GDD as Deliver Location Information is marked for deprecation

DEPRECATE

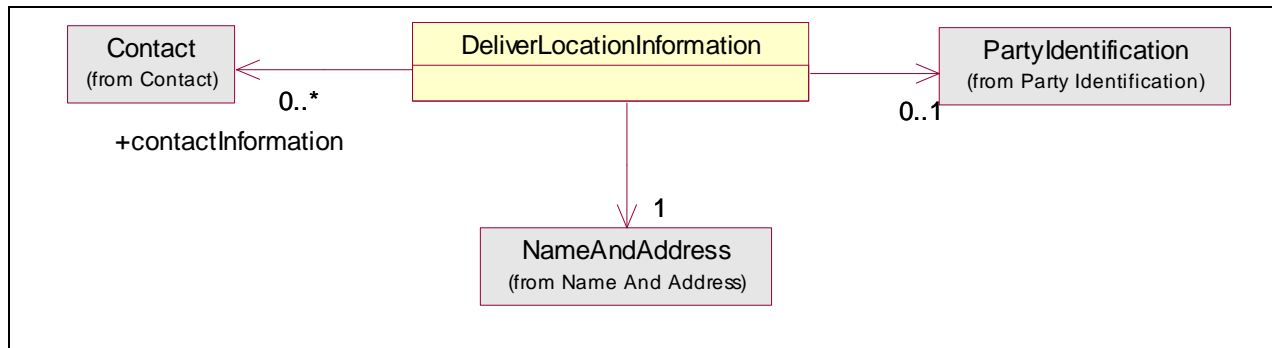

NEW

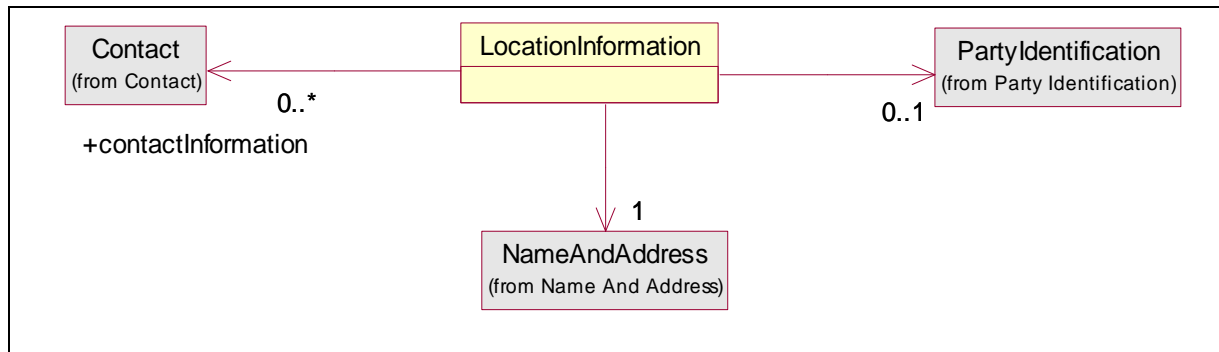

3.3.18. GDD Report: Deliver Location Information

Note: No GDD Report for Deliver Location Information reference Location Information

3.3.19. Class Diagram: Deliver Payment Method

Process Common Components: Deliver Common : Deliver Payment Method

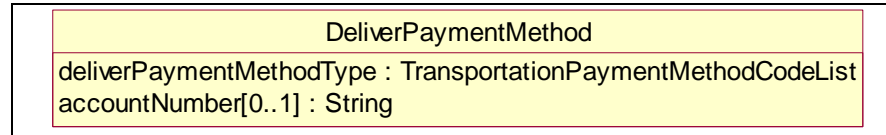

3.3.20. GDD Report: Deliver Payment Method

Class (ABIE)	Attribute (BBIE)	Association (ASBIE)	Secondary Class	Official Dictionary Entry Name	Definition	Multiplicity	Related Requirements
DeliverPaymentMethod				Deliver_ Payment Method. Details	Provides the payment method information details.		
	accountNumber			Deliver_ Payment Method. Account. Code	Identifier for the bank account number that is used for making payments.	0..1	
	deliverPaymentMethodType			Deliver_ Payment Method. Deliver_ Payment Method. Code	Code identifying the way the payment is going to be settled.	1..1	

3.3.21. Class Diagram: <<Deprecate>> Deliver Reference / Transportation Reference

Process Common Components: Deliver Common: Deliver Reference

Note: ***Reference Transportation Reference GDD as Deliver Reference is marked for deprecation ***

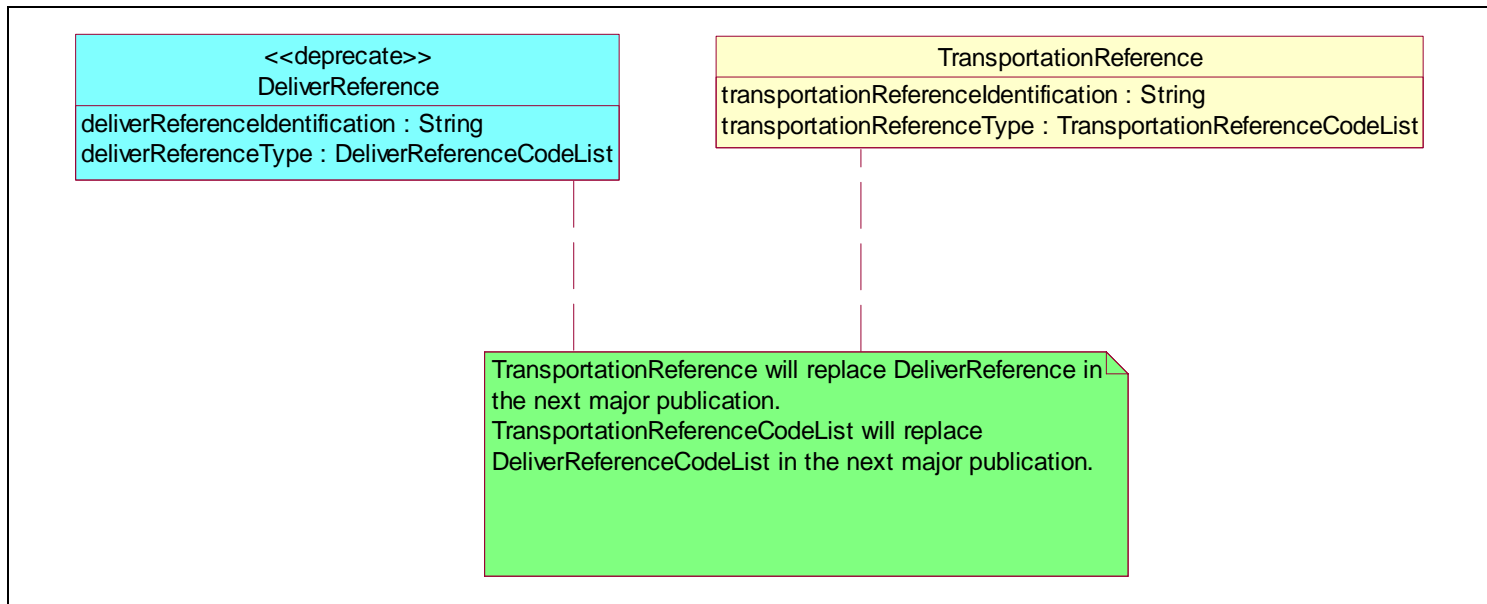

3.3.22. GDD Report: Deliver Reference / Transportation Reference

Note: **No GDD Report for Deliver Reference reference Transportation Reference**

3.3.23. Class Diagram: Deliver Shipment Information

Process Common Components: Deliver Common: Deliver Shipment Information

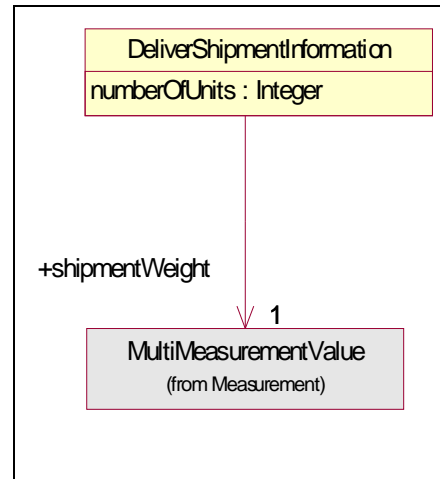

3.3.24. GDD Report: Deliver Shipment Information

Class (ABIE)	Attribute (BBIE)	Association (ASBIE)	Secondary Class	Official Dictionary Entry Name	Definition	Multiplicity	Related Requirements
DeliverShipmentInformation				Shipment Information. Details	Provides the number of units and the weight of the shipment.		
	numberOfUnits			Shipment Information. Number Of_ Units. Numeric	Identifies the number of units shipped	1..1	
		shipmentWeight	MultiMeasurementValue	Shipment Information. Shipment Weight_ Association. Multi-unit Measure	Weight and its associated unit of measure for a shipment.	1..1	

3.3.25. Class Diagram: Deliver Weight Information

Process Common Components: Deliver Common: Deliver Weight Information

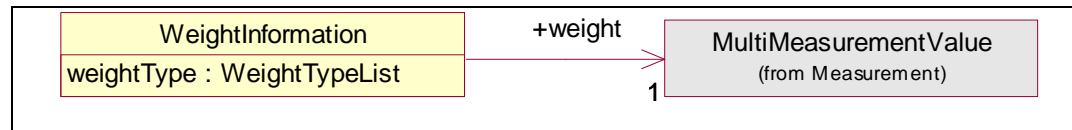

3.3.26. GDD Report: Deliver Weight Information

Class (ABIE)	Attribute (BBIE)	Association (ASBIE)	Secondary Class	Official Dictionary Entry Name	Definition	Multiplicity	Related Requirements
WeightInformation				Delivery_Weight_Dimension. Details	There is a combination of the weight and the corresponding weight type.		
	weightType			Delivery_Weight_Dimension. Weight_Type. Code	The qualification of the weight expressed from those contained in the enumerated list.	1..1	
		weight	MultiMeasureme ntValue	Delivery_Weight_Dimension. Weight_Association. Multi-unit Measure	Measures the heaviness of an object.	1..1	

3.3.27. Class Diagram: Despatch Information

Note: 200707 added Despatch Information as part of BMS Release 2.4.0 and Common Library Document Version 0.5.0

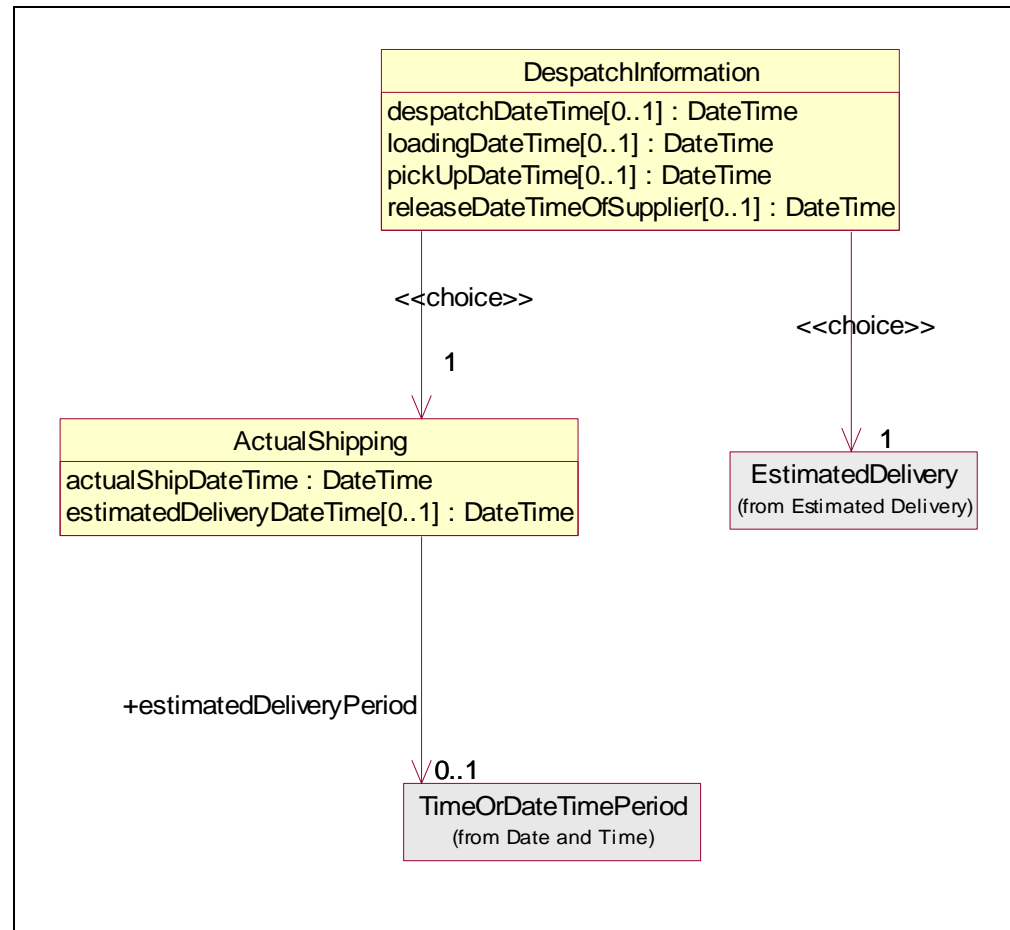

3.3.28. GDD Report: Despatch Information

Class (ABIE)	Attribute (BBIE)	Association (ASBIE)	Secondary Class	Official Dictionary Entry Name	Definition	Multiplicity	Related Requirements
ActualShipping				Actual Shipping. Details	ActualShipping contains the attributes actualShipDateTime and estimatedDeliveryDateTime.		[BRAD Upstream Standards – Despatch, Receipt & Consumption Version 0.1.1]{7.1.1-18, 19}
	actualShipDateTime			Actual Shipping. Actual Ship Date Time. Date Time	DateTime- The date and time the goods were shipped. The format is ISO 8601 CCYY-MM-DD "T" HH:MM:SS for all Date Time types.	1..1	[BRAD Upstream Standards – Despatch, Receipt & Consumption Version 0.1.1]{7.1.1-18, 19}
	estimatedDeliveryDateTime			Actual Shipping. Estimated Delivery Date Time. Date Time	DateTime- The estimated date and time of delivery.	0..1	[BRAD Upstream Standards – Despatch, Receipt & Consumption Version 0.1.1]{7.1.1-18, 19}
		estimatedDeliveryPeriod	TimeOrDateTimePeriod	Actual Shipping. Estimated Delivery Period Association. Time Or Date Time Period	Provides the estimated delivery period for the shipment.	0..1	[BRAD Upstream Standards – Despatch, Receipt & Consumption Version 0.1.1]{7.1.1-18, 19}
DespatchInformation				Despatch Information. Details	Information with regards to the despatching or shipping of goods.		[BRD Exchange Traceability and Processing History Data of Beef Products (Slaughter to Retail) Version 2.50]
	despatchDateTime			Despatch Information. Despatch Date Time. Date Time	Date/time on which the goods are or are expected to be despatched or shipped.	0..1	[BRD Exchange Traceability and Processing History Data of Beef Products (Slaughter to Retail) Version 2.50]
	loadingDateTime			Despatch Information. Loading Date Time. Date Time	The date/time on which the stuffing of a container is to take place, or has taken place.	0..1	[BRD Exchange Traceability and Processing History Data of Beef Products (Slaughter to Retail) Version 2.50]
	pickUpDateTime			Despatch Information. Pick Up Date Time. Date Time	Date/time at which the cargo is picked up.	0..1	[BRD Exchange Traceability and Processing History Data of Beef Products (Slaughter to Retail) Version 2.50]
	releaseDateTimeOfSupplier			Despatch Information. Release Date Time Of Supplier. Date Time	Date when the supplier released goods.	0..1	[BRD Exchange Traceability and Processing History Data of Beef Products (Slaughter to Retail) Version 2.50]
			ActualShipping	Despatch Information. Choice Association. Actual Shipping	This information on ActualShipping for DespatchInformation.	1..1	[BRD Exchange Traceability and Processing History Data of Beef Products (Slaughter to Retail) Version 2.50]
			EstimatedDelivery	Despatch Information. Choice Association. Estimated Delivery	This information on EstimatedDelivery for DespatchInformation.	1..1	[BRD Exchange Traceability and Processing History Data of Beef Products (Slaughter to Retail) Version 2.50]

3.3.30. Class Diagram: Equipment Information

Process Common Components: Deliver Common: Equipment Information

Note: 20060301 moved into common as reused in FTL Load Tender and now Transportation Rate Simple Request

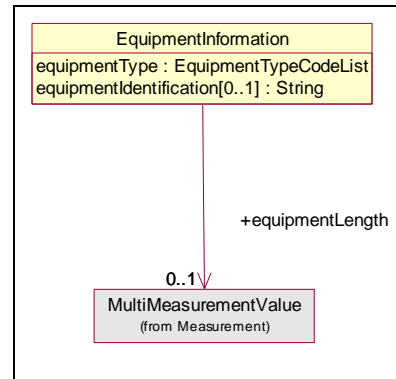

3.3.31. GDD Report: Equipment Information

Class (ABIE)	Attribute (BBIE)	Association (ASBIE)	Secondary Class	Official Dictionary Entry Name	Definition	Multiplicity	Related Requirements
EquipmentInformation				Equipment. Details	Equipment Information provides the type of equipment requested for the Full Truckload Load Tender. There may be identification of the equipment and the length of the equipment.		
	equipmentIdentification			Equipment. Equipment Identification_ Equipment Number. Text	The identification of the equipment unit represented as an alphanumeric data.	0..1	
	equipmentType			Equipment. Type. Equipment Type Code List_ Code	Code identifying equipment type.	1..1	

Class (ABIE)	Attribute (BBIE)	Association (ASBIE)	Secondary Class	Official Dictionary Entry Name	Definition	Multiplicity	Related Requirements
		equipmentLength	MultiMeasurementValue	Equipment. Equipment Length_ Association. Multi-unit Measure	Length of equipment ordered or used to transport shipment and the associated unit of measure. This value may be converted into multi measurement formats.	0..1	

3.3.33. Class Diagram: Freight Invoice Common

Process Common Components: Deliver Common: Freight Invoice Common

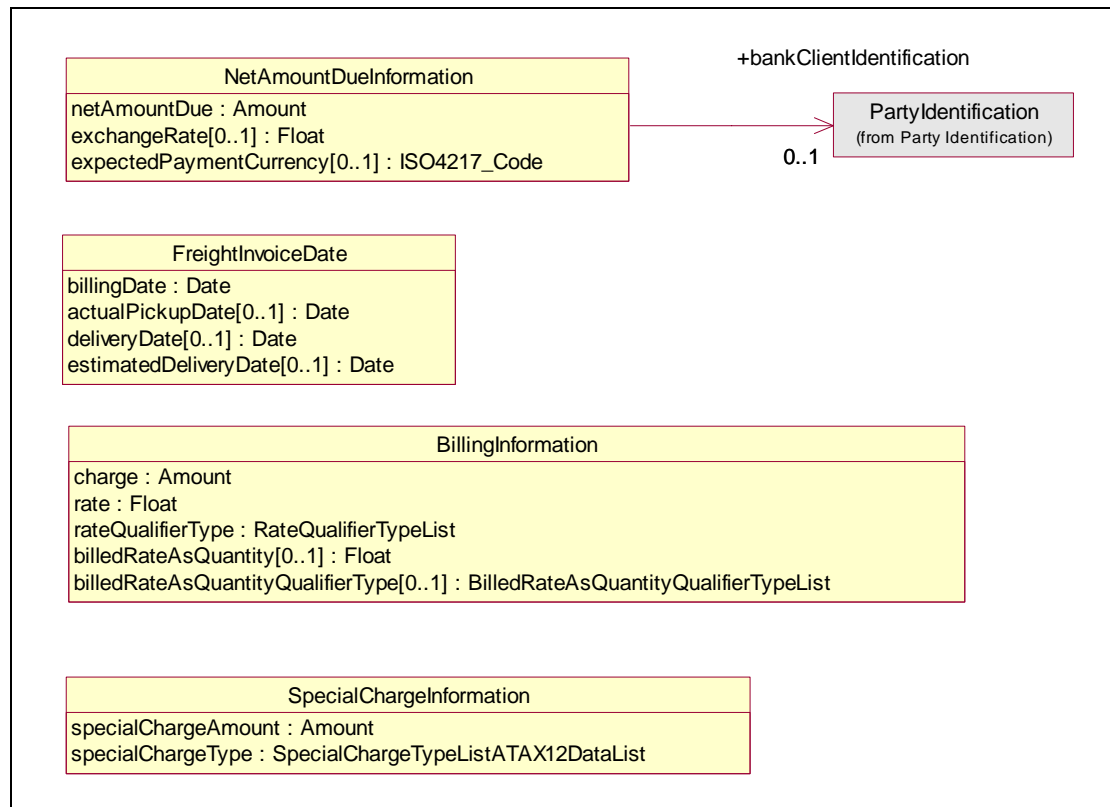

3.3.34. GDD Report: Freight Invoice Common

Class (ABIE)	Attribute (BBIE)	Association (ASBIE)	Secondary Class	Official Dictionary Entry Name	Definition	Multiplicity	Related Requirements
BillingInformation				Freight_ Invoice Sub Total. Details	Line item charges that make up the billed amount for a shipment		
	billedRateAsQuantity			Freight_ Invoice Sub Total. As Quantity_ Billed_ Rate. Numeric	Specific quantity billed for the line item.	0..1	
	billedRateAsQuantityQualifierType			Freight_ Invoice Sub Total. Billed Rate As Quantity Qualifier_ Type. Code	A selection from a list of qualifiers. As examples: miles or kilometers, load, 100 pounds and flat rate.	0..1	
	charge			Freight_ Invoice Sub Total. Charge. Code	Specific price demanded for a specific line item	1..1	
	rate			Freight_ Invoice Sub Total. Rate. Code	A quantity, amount, or degree of something measured per unit of something else , that applies to the specific line item being delineated	1..1	
	rateQualifierType			Freight_ Invoice Sub Total. Rate Qualifier_ Type. Rate Qualifier Type_ Code	Qualifier for the rate	1..1	
FreightInvoiceDate				Freight Invoice_ Date Group. Details	Information pertaining to various dates associated to the freight invoice.		
	actualPickupDate			Freight Invoice_ Date Group. Actual Pickup_ Date Time. Date Time	The actual pickup date of the freight by the carrier from the shipper.	0..1	
	billingDate			Freight Invoice_ Date Group. Billing_ Date Time. Date Time	The date the freight invoice was billed.	1..1	
	deliveryDate			Freight Invoice_ Date Group. Delivery_ Date Time. Date Time	The delivery date of the freight to the ship to party.	0..1	
	estimatedDeliveryDate			Freight Invoice_ Date Group. Estimated Delivery_ Date Time. DOTW_ Date Time	Anticipated date for the arrival of a delivery at the ship to destination.	0..1	

Class (ABIE)	Attribute (BBIE)	Association (ASBIE)	Secondary Class	Official Dictionary Entry Name	Definition	Multiplicity	Related Requirements
NetAmountDueInformation				Freight_ Invoice Total. Details	This contains the net amount due, and it may contain the exchange rate and the expected payment currency.		
	exchangeRate			Freight_ Invoice Total. Exchange_ Rate. Numeric	The ratio at which the principal unit of two currencies may be traded for the net amount due	0..1	
	expectedPaymentCurrency			Freight_ Invoice Total. Expected_ Payment_ Currency. Numeric	The identification of the currency included in the invoice.	0..1	
	netAmountDue			Freight_ Invoice Total. Net_ Due_ Amount. Numeric	Contains the net amount due and the associated currency in ISO format.	1..1	
		bankClientIdentification	PartyIdentification	Freight_ Invoice Total. Bank Client Identification_ Association. Party Identification	Unique identifier for a customer of a bank	0..1	
SpecialChargeInformation				Freight_ Charge_ Allowance Charge. Details	This contains the special charge amount and the special charge qualifier type.		
	specialChargeAmount			Freight_ Charge_ Allowance Charge. Special Charge_ Amount. Indicator	A monetary value associated with a type of allowance and charge.	1..1	
	specialChargeType			Freight_ Charge_ Allowance Charge. Special Charge_ Type. Special Charge_ Code	The qualifier for the special charge type, and the available special charge type can reference from the ATA X12 Data Element 150 list.	1..1	

3.3.35. Class Diagram: Hazardous Shipment Information

Process Common Components: Deliver Common: Hazardous Shipment Information

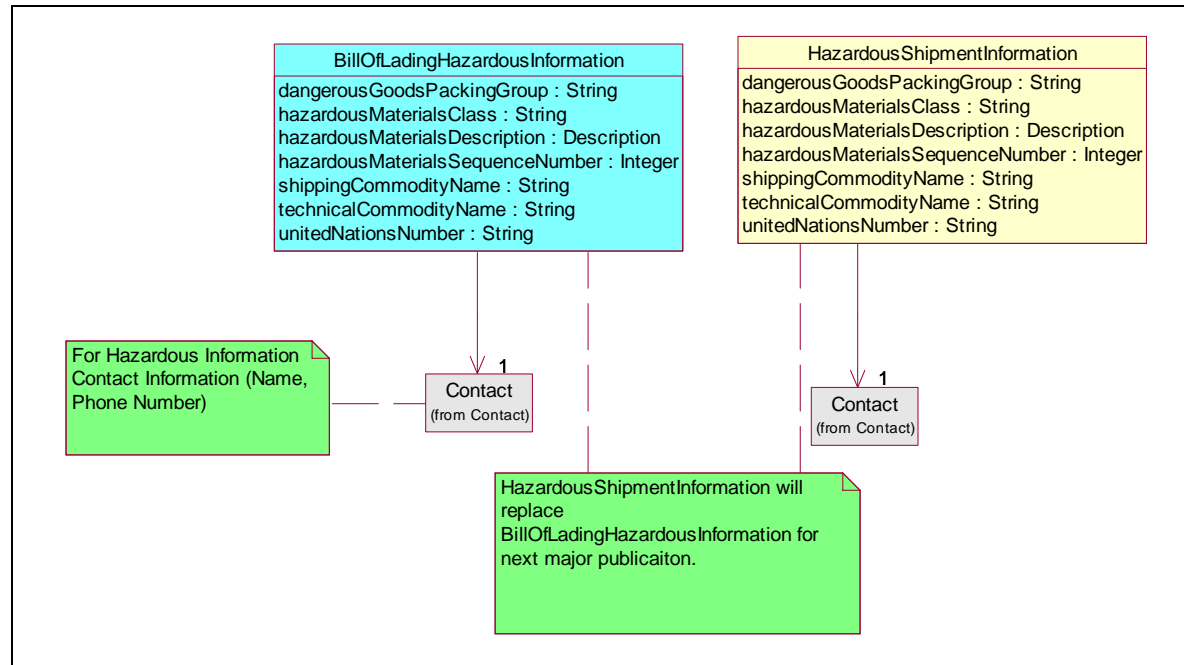

3.3.36. GDD Report: Hazardous Shipment Information

Class (ABIE)	Attribute (BBIE)	Association (ASBIE)	Secondary Class	Official Dictionary Entry Name	Definition	Multiplicity	Related Requirements
HazardousShipmentInfor mation				Hazardous Shipment Information_ Hazardous Goods. Details	Contains details related to the hazards related to transporting a good.		
	dangerousGo odsPackingGr oup			Hazardous Shipment Information_ Hazardous Goods. Dangerous Goods_ Packing Group. Identifier	The way dangerous goods are packed.	1..1	
	hazardousMat erialsClass			Hazardous Shipment Information_ Hazardous Goods. Hazardous Materials_ Class. Identifier	The name of the class within the classification of hazardous materials.	1..1	

Class (ABIE)	Attribute (BBIE)	Association (ASBIE)	Secondary Class	Official Dictionary Entry Name	Definition	Multiplicity	Related Requirements
	hazardousMaterialsDescription			Hazardous Shipment Information_Hazardous Goods. Hazardous Materials_ Description. Identifier	Description of the hazardous materials.	1..1	
	hazardousMaterialsSequenceNumber			Hazardous Shipment Information_Hazardous Goods. Hazardous Materials_ Sequence_ Number. Identifier	The order in which ingredients are ranked within a decomposition list of hazardous materials.	1..1	
	shippingCommodityName			Hazardous Shipment Information_Hazardous Goods. Shipping_ Commodity_ Name. Identifier	Name of a product being shipped	1..1	
	technicalCommodityName			Hazardous Shipment Information_Hazardous Goods. Technical_ Commodity_ Name. Identifier	Technical name for the product being shipped.	1..1	
	unitedNationsNumber			Hazardous Shipment Information_Hazardous Goods. United Nations_ Number. Identifier	Four-digit numbers used world-wide in international commerce and transportation to identify hazardous chemicals or classes of hazardous materials. These numbers generally range between 0000 and 3500 and are ideally preceded by the letters "UN" (for example, "UN1005") to avoid confusion with other number codes.	1..1	
		None	Contact	Hazardous Shipment Information_Hazardous Goods. Association. Contact	The contact information associated with a hazardous shipment.	1..1	

3.3.37. Class Diagram: Interline Carrier

Process Common Components: Deliver Common: Interline Carrier

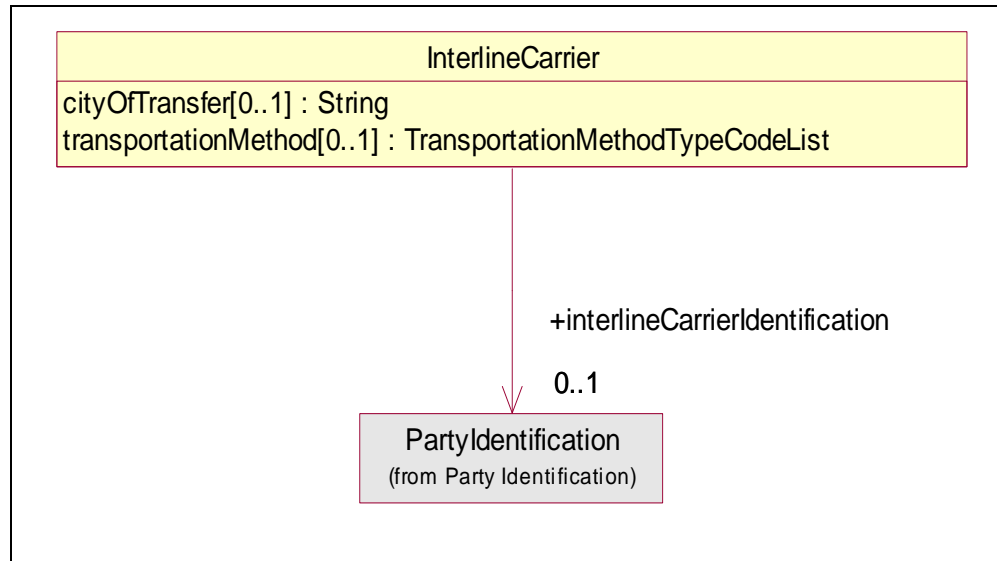

3.3.38. GDD Report: Interline Carrier

Class (ABIE)	Attribute (BBIE)	Association (ASBIE)	Secondary Class	Official Dictionary Entry Name	Definition	Multiplicity	Related Requirements
InterlineCarrier				Interline_ Shipment Transfer. Details	Provides the transportation method; city of transfer; and the interline carrier identification.		
	cityOfTransfer			Interline_ Shipment Transfer. Transfer_ City_ Location. Code	City where freight is to be transferred to the next carrier.	0..1	
	transportationMethod			Interline_ Shipment Transfer. Transportation_ Method. Code	Means for transporting goods from one point to another. e.g. Truck; rail; ocean	0..1	
		interlineCarrierIdentification	PartyIdentification	Interline_ Shipment Transfer. Interline_ Carrier Identification_ Association. Party Identification	Unique Identifier for an Interline Carrier (US context)	0..1	

3.3.39. Class Diagram: Inventory Status Line Item

Process Common Components: Process Common: Inventory Status Line Item

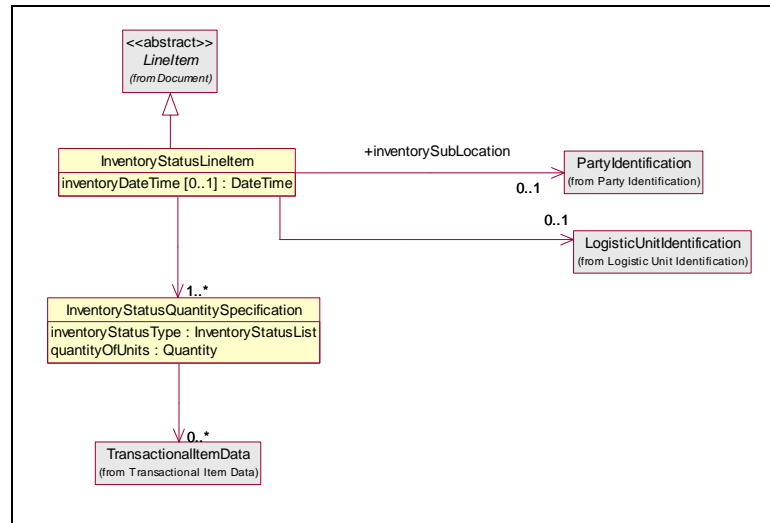

3.3.40. GDD Report: Inventory Status Line Item

Class (ABIE)	Attribute (BBIE)	Association (ASBIE)	Secondary Class	Official Dictionary Entry Name	Definition	Multiplicity	Related Requirements
InventoryStatusLinelItem				Inventory Status Line Item. Details	Information specifying the inventory status of a specific trade item at a specific location at a specific point in time.		
	inventoryDateTime			Inventory Status Line Item. Inventory Date Time. DOTW_Date Time	Date and time the inventory for this line item was assessed. If this is not provided the beginDateTime provided at the business document level represents the inventoryDateTime.	0..1	
			InventoryStatusQuantitySpecification	Inventory Status Line Item. Association. Inventory Status Quantity Specification	Information about the stored goods per inventory status.	1..*	

Class (ABIE)	Attribute (BBIE)	Association (ASBIE)	Secondary Class	Official Dictionary Entry Name	Definition	Multiplicity	Related Requirements
			LineItem	Inventory Status Line Item. Inheritance. Line Item	This information on line items for an inventory status line item.	1..1	
			LogisticUnitIdentification	Inventory Status Line Item. Association. Logistic Unit Identification	Detailed identification of the logistic unit that contains the goods.	0..1	
		inventorySubLocation	PartyIdentification	Inventory Status Line Item. Inventory Sub Location. Party Identification	Detailed identification of the location at which the goods are stored.	0..1	
InventoryStatusQuantity Specification				Inventory Status Quantity Specification. Details	Supplies the inventory status information with the quantity and the inventory status type.		
	inventoryStatusType			Inventory Status Quantity Specification. Inventory Status Type. Code	Code specifying the status of the goods.	1..1	
	quantityOfUnits			Inventory Status Quantity Specification. Quantity Of Units. Quantity	Quantity of goods with the specified status.	1..1	
			TransactionalItemData	Inventory Status Quantity Specification. Association. Transactional Item Data	Extended attributes describing the characteristics and history of the goods.	0..*	

3.3.41. Class Diagram: Item Containment

Process Common Components: Deliver Common: Item Containment

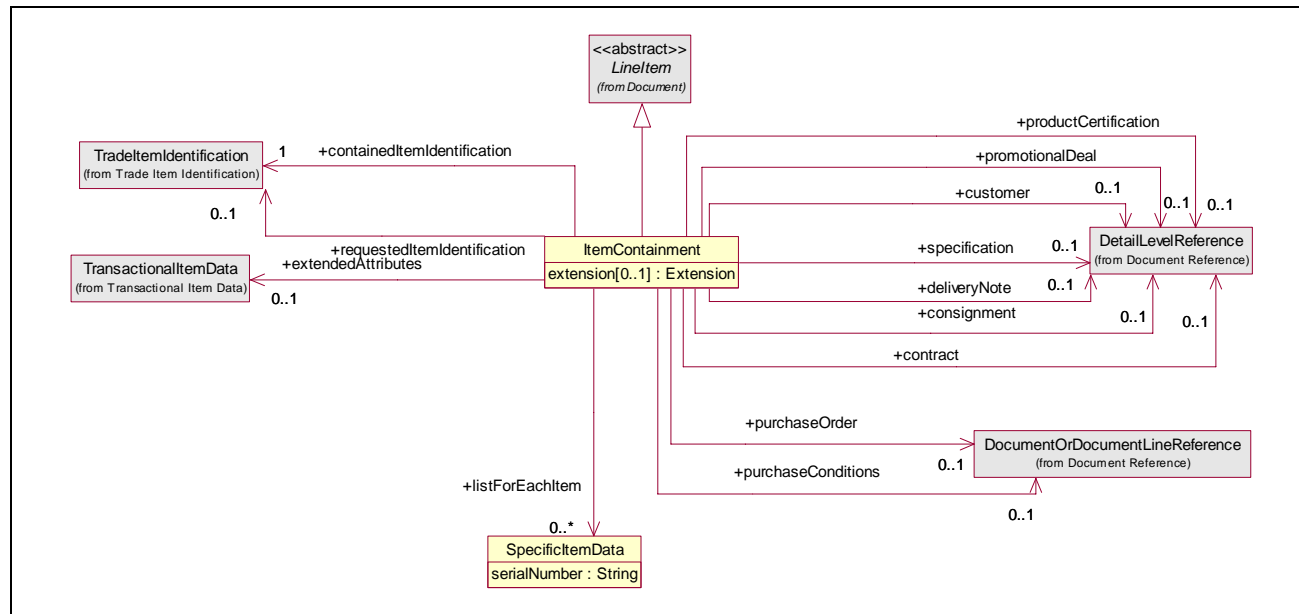

3.3.42. GDD Report: Item Containment

Class (ABIE)	Attribute (BBIE)	Association (ASBIE)	Secondary Class	Official Dictionary Entry Name	Definition	Multiplicity	Related Requirements
ItemContainment				Item Containment. Details	Information specifying the contents; characteristics; history and physical characteristics of delivered goods.		
	extension			Item Containment. Extension. Extension_ Text	Provides the extension for the item containment.	0..1	
		consignment	DetailLevelReference	Item Containment. Consignment. Detail Level Reference	Reference to the identification of the consignment.	0..1	
		contract	DetailLevelReference	Item Containment. Contract. Detail Level Reference	Reference to the contractual agreement under which the goods are delivered.	0..1	

Class (ABIE)	Attribute (BBIE)	Association (ASBIE)	Secondary Class	Official Dictionary Entry Name	Definition	Multiplicity	Related Requirements
		customer	DetailLevelReference	Item Containment. Customer. Detail Level Reference	Reference to the end customer that will receive the goods.	0..1	
		deliveryNote	DetailLevelReference	Item Containment. Delivery Note. Detail Level Reference	Reference to the physical document that accompanies the delivered goods.	0..1	
		productCertification	DetailLevelReference	Item Containment. Product Certification. Detail Level Reference	Reference to a number assigned by a governing body (or their agents) to a product which certifies compliance with a standard.	0..1	
		promotionalDeal	DetailLevelReference	Item Containment. Promotional Deal. Detail Level Reference	Reference to a number assigned by a vendor to a special promotion activity.	0..1	
		specification	DetailLevelReference	Item Containment. Specification. Detail Level Reference	!!definition missing	0..1	
		purchaseConditions	DocumentOrDocumentLineReference	Item Containment. Purchase Conditions. Document Or Document Line Reference	Reference to the business document that describes the commercial conditions under which the goods are delivered.	0..1	
		purchaseOrder	DocumentOrDocumentLineReference	Item Containment. Purchase Order. Document Or Document Line Reference	Reference to the business document that triggered the delivery of the goods.	0..1	
			LineItem	Item Containment. Inheritance. Line Item	This information on line items for an item containment.	1..1	
		listForEachItem	SpecificItemData	Item Containment. List For Each Item. Specific Item	The list of serial numbers for the delivered goods.	0..*	
		containedItemIdentification	TradeItemIdentification	Item Containment. Contained Item Identification. Trade Item Identification	The trade item identification of the goods that were delivered.	1..1	
		requestedItemIdentification	TradeItemIdentification	Item Containment. Requested Item Identification. Trade Item Identification	The trade item identification of the goods that were ordered or planned to be delivered.	0..1	
		extendedAttributes	TransactionalItemData	Item Containment. Extended Attributes. Transactional Item Data	Information specifying the characteristics and history of the delivered goods.	0..1	
SpecificItemData				Specific Item. Details	Information about the individual items that were delivered.		
	serialNumber			Specific Item. Serial. Text	A unique identifier assigned to a specific trade item.	1..1	

3.3.43. Class Diagram: Location Information

Process Common Components: Deliver Common: Location Information

Note: ***Reference Location Information GDD as Deliver Location Information is marked for deprecation ***

DEPRECATE

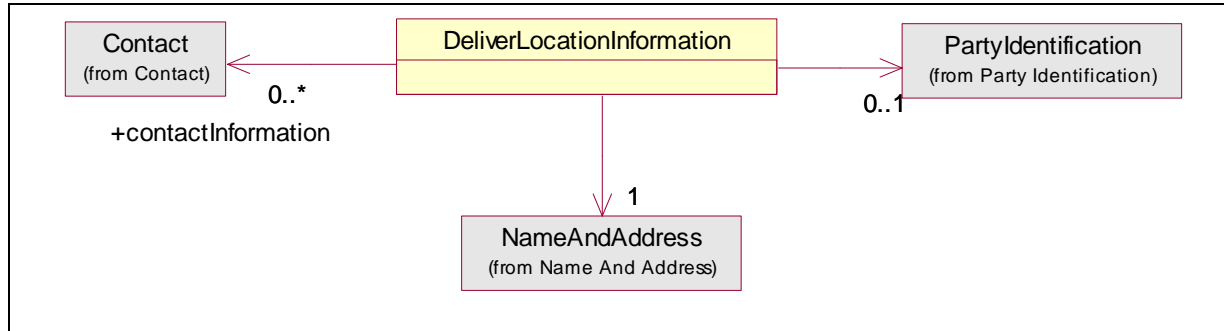

NEW

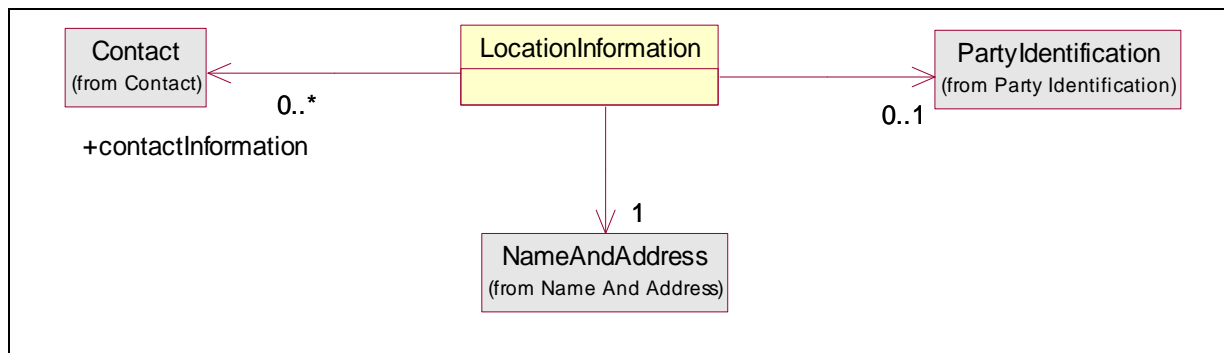

3.3.44. GDD Report: Location Information

Class (ABIE)	Attribute (BBIE)	Association (ASBIE)	Secondary Class	Official Dictionary Entry Name	Definition	Multiplicity	Related Requirements
LocationInformation				Location Information. Details	Provides the contact; name and address; and GLN of the location		
		contactInformation	Contact	Location Information. Association. Contact	Provides the contact information.	0..*	
			NameAndAddress	Location Information. Association. Party Address Group	Provides the location's name and address.	1..1	
			PartyIdentification	Location Information. Association. Party Identification	Provides the location's Global Location Number	0..1	

3.3.45. Class Diagram: Logistic Unit Measurement

Process Common Components: Deliver Common: Logistic Unit Measurement

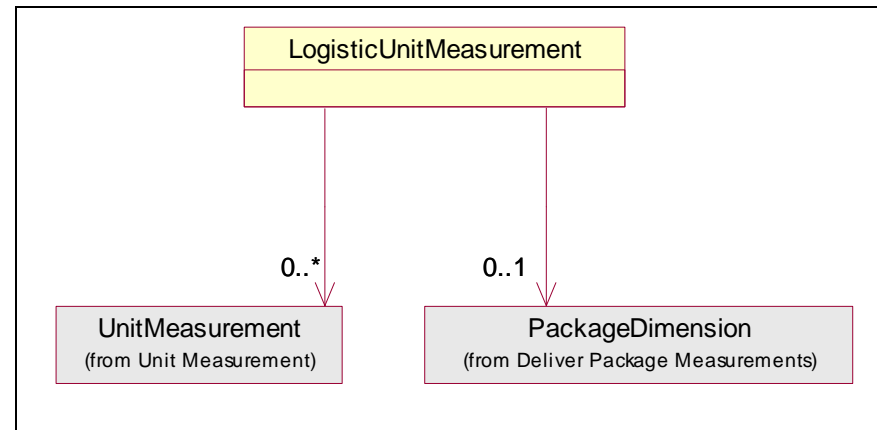

3.3.46. GDD Report: Logistic Unit Measurement

Class (ABIE)	Attribute (BBIE)	Association (ASBIE)	Secondary Class	Official Dictionary Entry Name	Definition	Multiplicity	Related Requirements
LogisticUnitMeasurement				Logistic Unit Measurement. Details	not available		
			PackageDimension	Logistic Unit Measurement. Association. Package Dimension	not available	0..1	
			UnitMeasurement	Logistic Unit Measurement. Association. Unit Measurement	not available	0..*	

3.3.47. Class Diagram: Logistic Units

Process Common Components: Deliver Common: Logistic Units

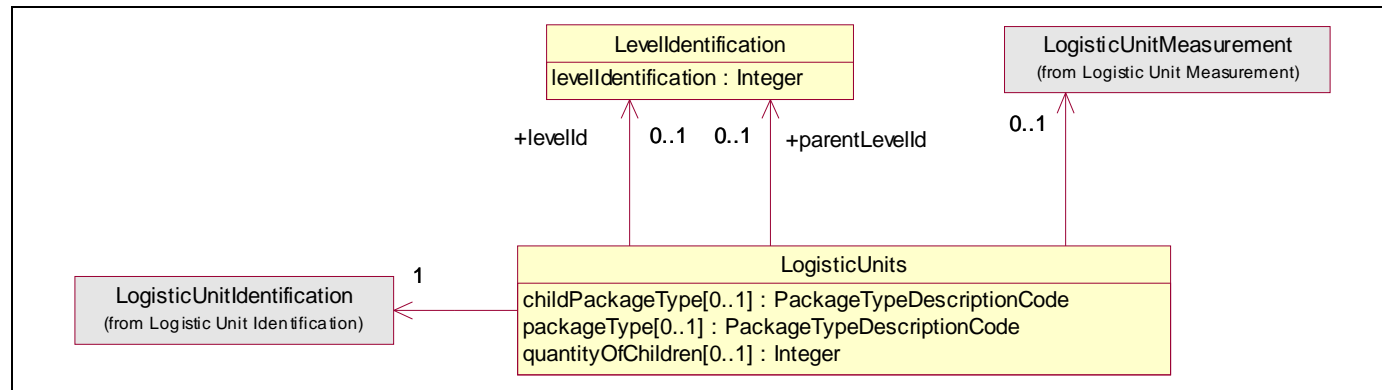

3.3.48. GDD Report: Logistic Units

Class (ABIE)	Attribute (BBIE)	Association (ASBIE)	Secondary Class	Official Dictionary Entry Name	Definition	Multiplicity	Related Requirements
LevelIdentification				Level Identification. Details	To identify the sequence in which physical packing is presented in the consignment; and optionally to identify the hierarchical relationship between packing layers.		
	levelIdentification			Level Identification. Level Identification. Integer_ Numeric	Hierarchical structure identifier.	1..1	
LogisticUnits				Logistic Units. Details	Information specifying the physical appearance; the physical dimensions as well as the contents of a specific logistic unit.		
	childPackageType			Logistic Units. Child PackageType. Code	Code specifying the type of the included (lower level) package.	0..1	
	packageType			Logistic Units. Package Type. Code	Code specifying the type of package.	0..1	
	quantityOfChildren			Logistic Units. Quantity Of Children. Integer_ Numeric	Number of packages at the next lower level.	0..1	
		levelId	LevelIdentification	Logistic Units. Level Id. Level Identification	Hierarchical structure level identifier (Sequential numbering recommended).	0..1	
		parentLevelId	LevelIdentification	Logistic Units. Parent Level Id. Level Identification	Hierarchical structure parent identifier	0..1	

Class (ABIE)	Attribute (BBIE)	Association (ASBIE)	Secondary Class	Official Dictionary Entry Name	Definition	Multiplicity	Related Requirements
			LogisticUnitId entification	Logistic Units. Association. Logistic Unit Identification	The globally unique identification attached to the logistic unit; used for logistical and traceability purposes.	1..1	
			LogisticUnitMeasurement	Logistic Units. Association. Logistic Unit Measurement	The physical dimensions of the logistic unit.	0..1	

3.3.49. Class Diagram: Package Dimension

Process Common Components: Deliver Common: Package Dimension

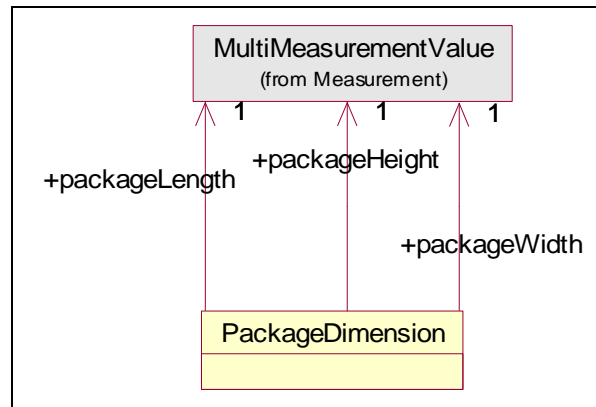

3.3.50. GDD Report: Deliver Package Dimension

Class (ABIE)	Attribute (BBIE)	Association (ASBIE)	Secondary Class	Official Dictionary Entry Name	Definition	Multiplicity	Related Requirements
PackageDimension				Package Dimension. Details	Provides the package height, package length, and package width of an item with their associated unit of measure. The unit of measure may be represented in multiple formats.		
		packageHeight	MultiMeasurementValue	Package Dimension. Package Height. Multi Measurement Value	The vertical dimension from the lowest extremity to the highest extremity.	1..1	
		packageLength	MultiMeasurementValue	Package Dimension. Package Length. Multi Measurement Value	The extent, measurement, or dimension downward, backward, or inward.	1..1	
		packageWidth	MultiMeasurementValue	Package Dimension. Package Width. Multi Measurement Value	The measurement of the extent of something from side to side. Width is the measurement from left to right.	1..1	

3.3.51. Class Diagram: Purchase Order Information

Process Common Components: Deliver Common: Purchase Order Information

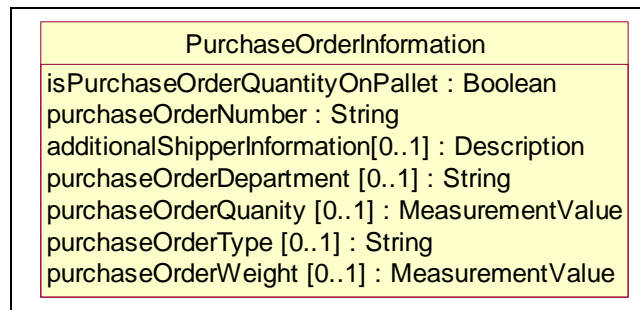

3.3.52. GDD Report: Purchase Order Information

Class (ABIE)	Attribute (BBIE)	Association (ASBIE)	Secondary Class	Official Dictionary Entry Name	Definition	Multiplicity	Related Requirements
PurchaseOrderInformation				Purchase Order Information. Details	This provides the detail purchase order information.		
	additionalShipperInformation			Purchase Order Information. Additional Shipper Information. {1..200}_Text	not available	0..1	
	isPurchaseOrderQuantityOnPallet			Purchase Order Information. Is Purchase Order Quantity On Pallet. Indicator	not available	1..1	
	purchaseOrderDepartment			Purchase Order Information. Department. Text	not available	0..1	
	purchaseOrderNumber			Purchase Order Information. Number. Text	not available	1..1	
	purchaseOrderQuantity			Purchase Order Information. Quantity. Quantity	not available	0..1	
	purchaseOrderType			Purchase Order Information. Type. Text	not available	0..1	
	purchaseOrderWeight			Purchase Order Information. Total Weight. Measure	not available	0..1	

3.3.53. Class Diagram: Shipment Seal Information

Process Common Components: Deliver Common: Shipment Seal Information

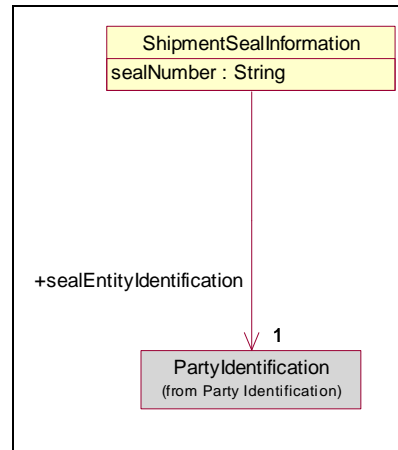

3.3.54. GDD Report: Shipment Seal Information

Class (ABIE)	Attribute (BBIE)	Association (ASBIE)	Secondary Class	Official Dictionary Entry Name	Definition	Multiplicity	Related Requirements
ShipmentSealInformation				Shipment_Seal. Details	The unique identifier for the sealing of a truck or container for a shipment.		
	sealNumber			Shipment_Seal. Seal_Number. Text	The number marked on the physical seal applied to a trailer.	1..1	
		sealEntityIdentification	PartyIdentification	Shipment_Seal. Seal_Party Identification_Association. Party Identification	Unique identifier for the Seal Entity.	1..1	

3.3.55. Class Diagram: Stop Location Information

Process Common Components: Deliver Common: Stop Location Information

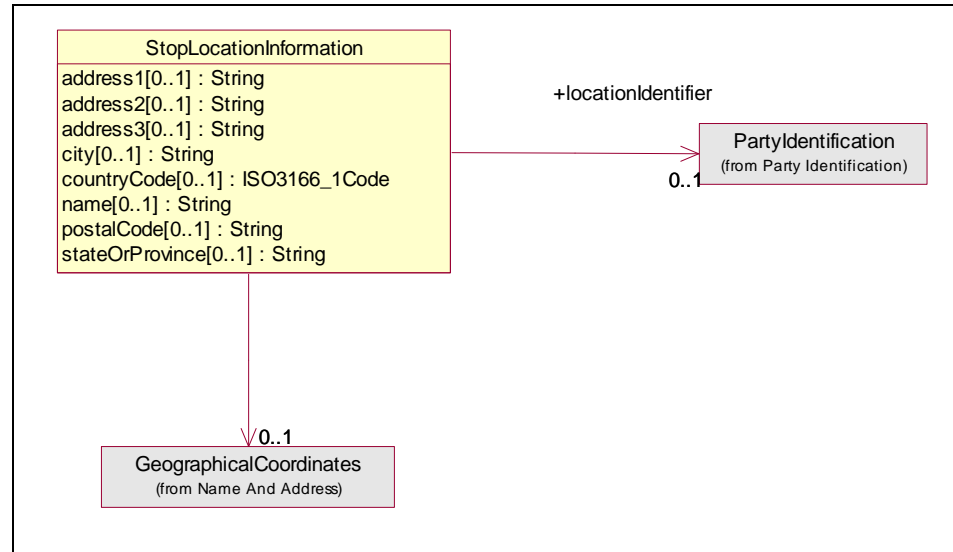

3.3.56. GDD Report: Stop Location Information

Class (ABIE)	Attribute (BBIE)	Association (ASBIE)	Secondary Class	Official Dictionary Entry Name	Definition	Multiplicity	Related Requirements
StopLocationInformation				Stop_ Transport Location. Details	Information pertaining to the name and address information for a specific stop location.		
	address1			Stop_ Transport Location. 1_ Address. Text	Text to provide street address information for a location where status event took place	0..1	
	address2			Stop_ Transport Location. 2_ Address. Text	Text to provide street address information for a location where status event took place.	0..1	
	address3			Stop_ Transport Location. 3_ Address. Text	Text to provide street address information for a location where status event took place	0..1	
	city			Stop_ Transport Location. City. Text	An inhabited place of greater size, population, or importance than a town or village where a status event took place	0..1	

Class (ABIE)	Attribute (BBIE)	Association (ASBIE)	Secondary Class	Official Dictionary Entry Name	Definition	Multiplicity	Related Requirements
	countryCode			Stop_ Transport Location. Country. Text	ISO 3661-1 Country Code of location where status event took place.	0..1	
	name			Stop_ Transport Location. Name. Text	The name of the party expressed in text.	0..1	
	postalCode			Stop_ Transport Location. Postal Code. Text	Postal Code/Zip Code of location where status event took place.	0..1	
	stateOrProvince			Stop_ Transport Location. State Or Province. Text	State: one of the constituent units of a nation having a federal government . Province: an administrative district or division of a country	0..1	
		None	GeographicalCoordinates	Stop_ Transport Location. Association. Geographical Coordinate	This information on GeographicalCoordinates for StopLocationInformation.	0..1	
		locationIdentifier	PartyIdentification	Stop_ Transport Location. Location_ Identification. Party Identification	To specify any identifier related to this location such as a UNLOCODE, EAN.UCC GLN, etc.	0..1	

3.3.57. Class Diagram: Transactional Item Data

Process Common Components: Deliver Common: Transactional Item Data

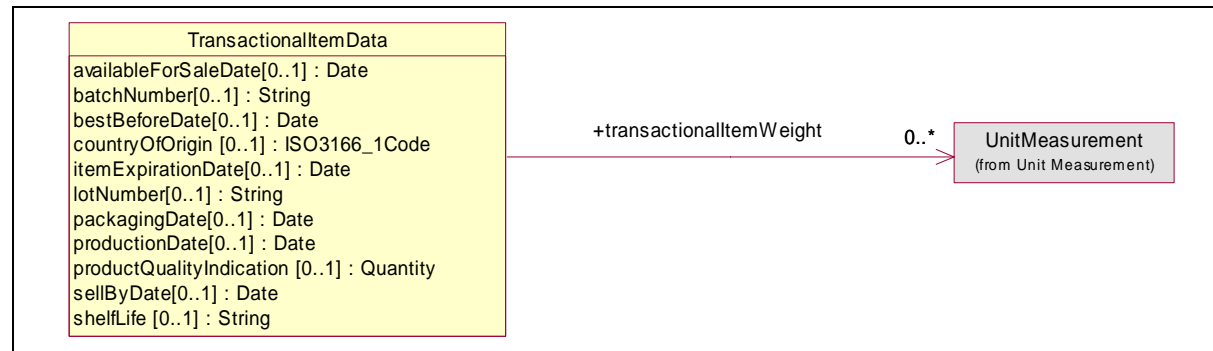

3.3.58. GDD Report: Transactional Item Data

Class (ABIE)	Attribute (BBIE)	Association (ASBIE)	Secondary Class	Official Dictionary Entry Name	Definition	Multiplicity	Related Requirements
TransactionalItemData				Transactional_ Trade Item Containment Line. Details	Provides the transactional item data information.		
	availableForSaleDate			Transactional_ Trade Item Containment Line. Available For Sale Date. Date Time	Date - The date the item is available for sale represented in CCYY-MM-DD.	0..1	
	batchNumber			Transactional_ Trade Item Containment Line. Batch Number. Text	A batch unites products or items that have undergone or are grouped together to undergo the same transformation process, not necessarily a production process.	0..1	
	bestBeforeDate			Transactional_ Trade Item Containment Line. Best Before Date. Date Time	Ideal consumption or best effective use date of a product.	0..1	
	countryOfOrigin			Transactional_ Trade Item Containment Line. Of Origin_ Country. ISO_ Country_ Code	Country from which the goods are supplied.	0..1	
	itemExpirationDate			Transactional_ Trade Item Containment Line. Item Expiration_ Date. Date Time	Date - The maximum durability of an item CCYY-MM-DD. The format is ISO 8601 CCYY-MM-DD for all data types.	0..1	
	lotNumber			Transactional_ Trade Item Containment Line. Lot Number. Text	A distinctive combination of numbers and/or letters from which the complete history of the manufacture; processing; packaging; coding and distribution of a batch can be determined.	0..1	
	packagingDate			Transactional_ Trade Item Containment Line. Packaging_ Date. Date Time	The date on which the packaging of a product took place.	0..1	
	productionDate			Transactional_ Trade Item Containment Line. Production Date. Date Time	Date - The date that the product was produced.	0..1	

Class (ABIE)	Attribute (BBIE)	Association (ASBIE)	Secondary Class	Official Dictionary Entry Name	Definition	Multiplicity	Related Requirements
	productQualityIndication			Transactional_ Trade Item Containment Line. Product Quality Indication. Quantity Type Code_ Code	Number used to indicate the quality of a specific batch of products. Optionally a Unit of Measure can be specified, which means that the number is expressed per unit. Ex-ample: 100 GRM means 100 per gram.	0..1	
	sellByDate			Transactional_ Trade Item Containment Line. Sell By Date. Date Time	Date - Maximum durability date of an item CCYY-MM-DD.	0..1	
	shelfLife			Transactional_ Trade Item Containment Line. Shelf Life. Text	The length of time a material; substance; product; or reagent can be stored under specified environmental conditions and continue to meet all applicable specification requirements and/or remain suitable for its intended function.	0..1	
		transactionalItemWeight	UnitMeasurement	Transactional_ Trade Item Containment Line. Transactional Item Weight Association. Unit Measurement	Weight is a measurement of the gravitational force acting on a transactional object.	0..*	

3.3.59. Class Diagram: Transportation Reference

Process Common Components: Deliver Common: Transportation Reference



Note: ***Reference Transportation Reference GDD as Deliver Reference is marked for deprecation ***

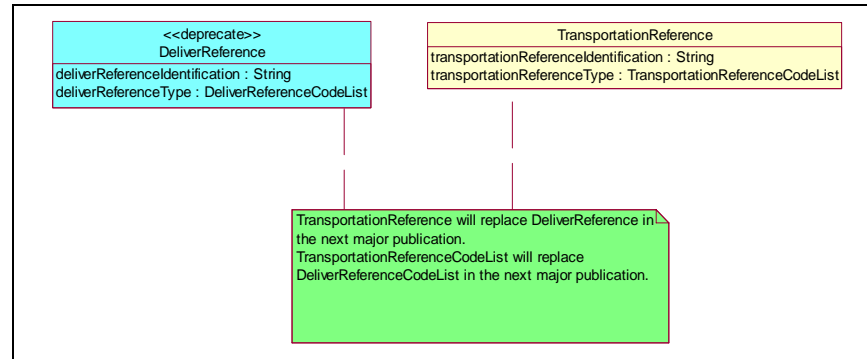

3.3.60. GDD Report: Transportation Reference

Class (ABIE)	Attribute (BBIE)	Association (ASBIE)	Secondary Class	Official Dictionary Entry Name	Definition	Multiplicity	Related Requirements
TransportationReference				Transportation_ Entity Reference. Details	Number used to reference package or shipment for the purposes of status inquiry.		
	transportationReferenceIdentification			Transportation_ Entity Reference. Deliver Reference_ Identification. Code	Identifies; from a pre-defined list; which unique identification mechanism is to be used as reference for delivery.	1..1	
	transportationReferenceType			Transportation_ Entity Reference. Transportation Reference_ Type. Code	Identifies; from a pre-defined list; the way delivery is referenced.	1..1	

3.3.61. Class Diagram: Unit Measurement

Process Common Components: Deliver Common: Unit Measurement

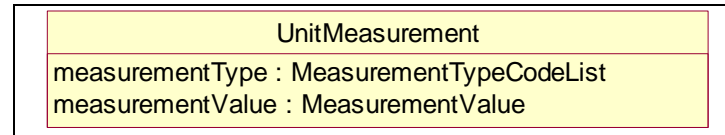

3.3.62. GDD Report: Unit Measurement

Class (ABIE)	Attribute (BBIE)	Association (ASBIE)	Secondary Class	Official Dictionary Entry Name	Definition	Multiplicity	Related Requirements
UnitMeasurement				Unit Measurement. Details	Information specifying the weight or volume of a unit.		
	measurementType			Unit Measurement. Measurement Type. Code	Specification of the attribute measured	1..1	
	measurementValue			Unit Measurement. Measurement Value. Measure	Value of the attribute measured.	1..1	

3.4. Package Overview: Global Search Common

3.5. Process Common Components: Global Search Common

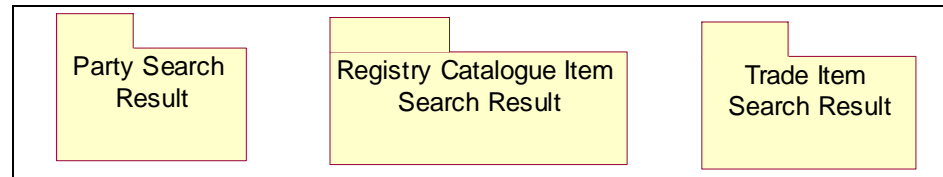

3.5.1. Class Diagram: Party Search Result

Process Common Components: Global Search Common: Party Search Result

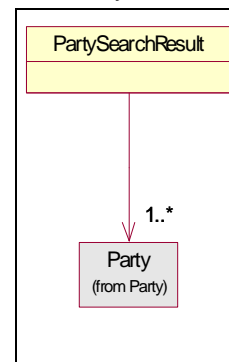

3.5.2. GDD Report: Party Search Result

Class (ABIE)	Attribute (BBIE)	Association (ASBIE)	Secondary Class	Official Dictionary Entry Name	Definition	Multiplicity	Related Requirements
PartySearchResult				Party_ Search Result. Details	Provides the party search result details.		
			Party	Party_ Search Result. Association. Party	This information on Party for PartySearchResult.	1..*	

3.5.3. Class Diagram: Registry Catalogue Item Search Result

Process Common Components: Global Search Common: Registry Catalogue Item Search Result

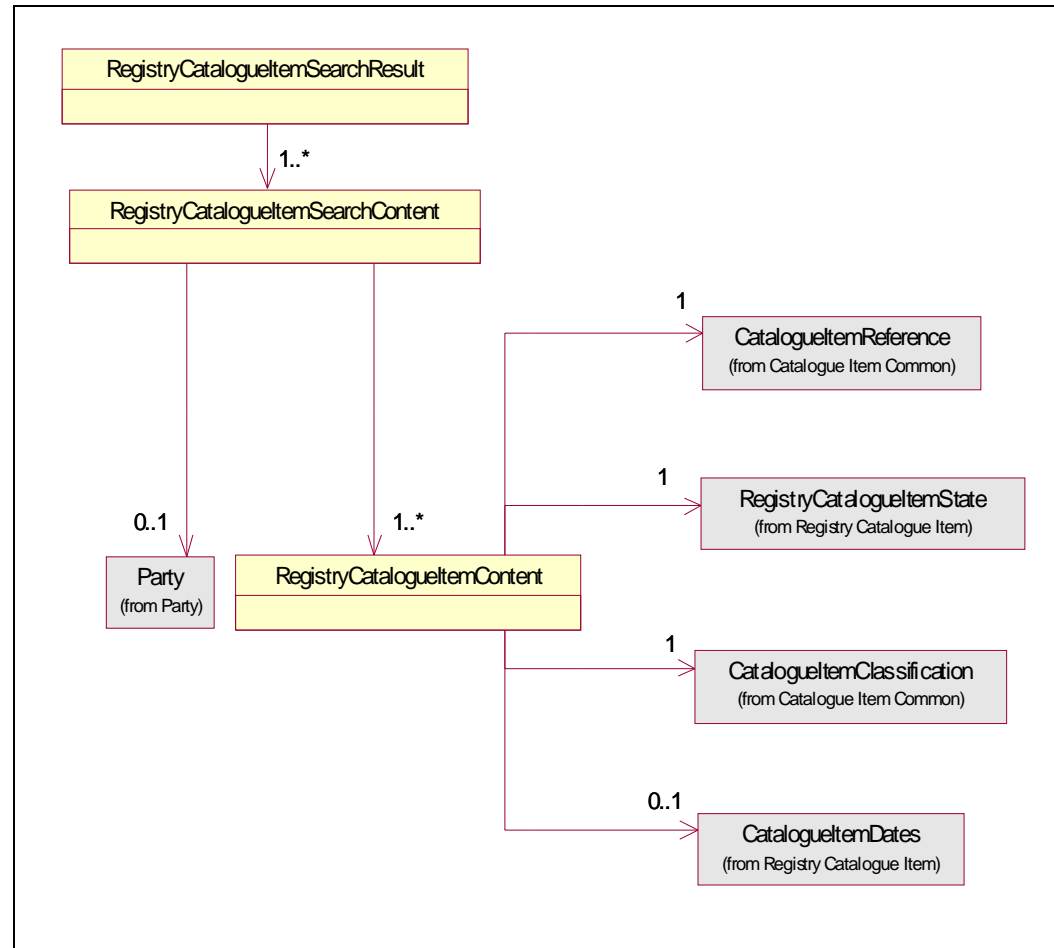

3.5.4. GDD Report: Registry Catalogue Item Search Result

Class (ABIE)	Attribute (BBIE)	Association (ASBIE)	Secondary Class	Official Dictionary Entry Name	Definition	Multiplicity	Related Requirements
RegistryCatalogueItemContent				Registry Catalogue Item_ Search Content Line. Details	Provides the catalogue item reference; registry catalogue item state; catalogue item classification; and catalogue item dates.		
			CatalogueItemClassification	Registry Catalogue Item_ Search Content Line. Association. GPC_ Product Classification	This information on CatalogueItemClassification for RegistryCatalogueItemContent.	1..1	
			CatalogueItemDates	Registry Catalogue Item_ Search Content Line. Association. Catalogue Item_ Date Group	This information on CatalogueItemDates for RegistryCatalogueItemContent.	0..1	
			CatalogueItemReference	Registry Catalogue Item_ Search Content Line. Association. Catalogue Item Identification	This information on CatalogueItemReference for RegistryCatalogueItemContent.	1..1	
			RegistryCatalogueItemState	Registry Catalogue Item_ Search Content Line. Association. Registry_ Catalogue Item State	This information on RegistryCatalogueItemState for RegistryCatalogueItemContent.	1..1	
RegistryCatalogueItemSearchContent				Registry Catalogue Item_ Search Content. Details	Provides the party information and the registry catalogue item content.		
			Party	Registry Catalogue Item_ Search Content. Association. Party	This information on Party for RegistryCatalogueItemSearchContent.	0..1	
			RegistryCatalogueItemContent	Registry Catalogue Item_ Search Content. Association. Registry Catalogue Item_ Search Content Line	This information on RegistryCatalogueItemContent for RegistryCatalogueItemSearchContent.	1..*	
RegistryCatalogueItemSearchResult				Registry Catalogue Item_ Search Result. Details	Provides the registry catalogue item search content.		
			RegistryCatalogueItemSearchContent	Registry Catalogue Item_ Search Result. Association. Registry Catalogue Item_ Search Content	This information on RegistryCatalogueItemSearchContent for RegistryCatalogueItemSearchResult.	1..*	

3.5.5. Class Diagram: Trade Item Search Result

Process Common Components: Global Search Common: Trade Item Search Result

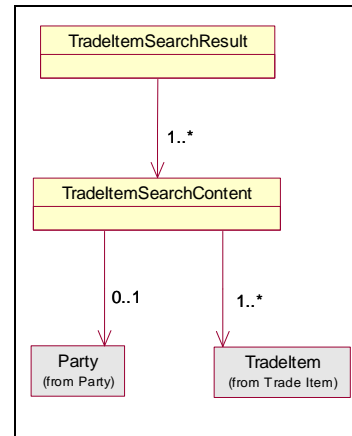

3.5.6. GDD Report: Trade Item Search Result

Class (ABIE)	Attribute (BBIE)	Association (ASBIE)	Secondary Class	Official Dictionary Entry Name	Definition	Multiplicity	Related Requirements
TradeltemSearchContent				Trade Item_ Search Content. Details	Provides the trade item and party information.		
			Party	Trade Item_ Search Content. Association. Party	This information on Party for TradeltemSearchContent.	0..1	
			Tradeltem	Trade Item_ Search Content. Association. Trade Item	This information on Tradeltem for TradeltemSearchContent.	1..*	
TradeltemSearchResult				Trade Item_ Search Result. Details	Provides the trade item search result details.		
			TradeltemSearchContent	Trade Item_ Search Result. Association. Trade Item_ Search Content	This information on TradeltemSearchContent for TradeltemSearchResult.	1..*	

3.6. Package Overview: Order Common

Process Common Components: Order Common: Order Common

3.6.1. Class Diagram: Order Header Indicator

Process Common Components: Order Common: Order Header Indicator

OrderHeaderIndicator
isApplicationReceiptAcknowledgementRequired : Boolean
isOrderFreeOfExciseTaxDuty : Boolean

3.6.2. GDD Report: Order Header Indicator

Class (ABIE)	Attribute (BBIE)	Association (ASBIE)	Secondary Class	Definition	Multiplicity	Data Type Components	Related Requirements
OrderHeaderIndicator				Contains the order header indicator information.			[BRAD For Multi Shipment Order Receipt Response and Excise Tax Free V 0.0.4] {BR 1 BR 2}
	isApplicationReceiptAcknowledgementRequired			A buyer's requirement to receive an order receipt acknowledgement from the seller's application system to ensure the seller received the order message.	1..1	Boolean	[BRAD For Multi Shipment Order Receipt Response and Excise Tax Free V 0.0.4] {BR 1 BR 2}
	isOrderFreeOfExciseTaxDuty			An excise tax is a tax applied to the consumption of a particular type of good, such as alcohol or tobacco. Excise taxes apply at the same rates to domestic or imported goods. They must not be confused with customs duties which apply to imports only.	1..1	Boolean	[BRAD For Multi Shipment Order Receipt Response and Excise Tax Free V 0.0.4] {BR 1 BR 2}

3.6.3. Class Diagram: Order Logistical Information

Process Common Components: Order Common: Order Logistical Information

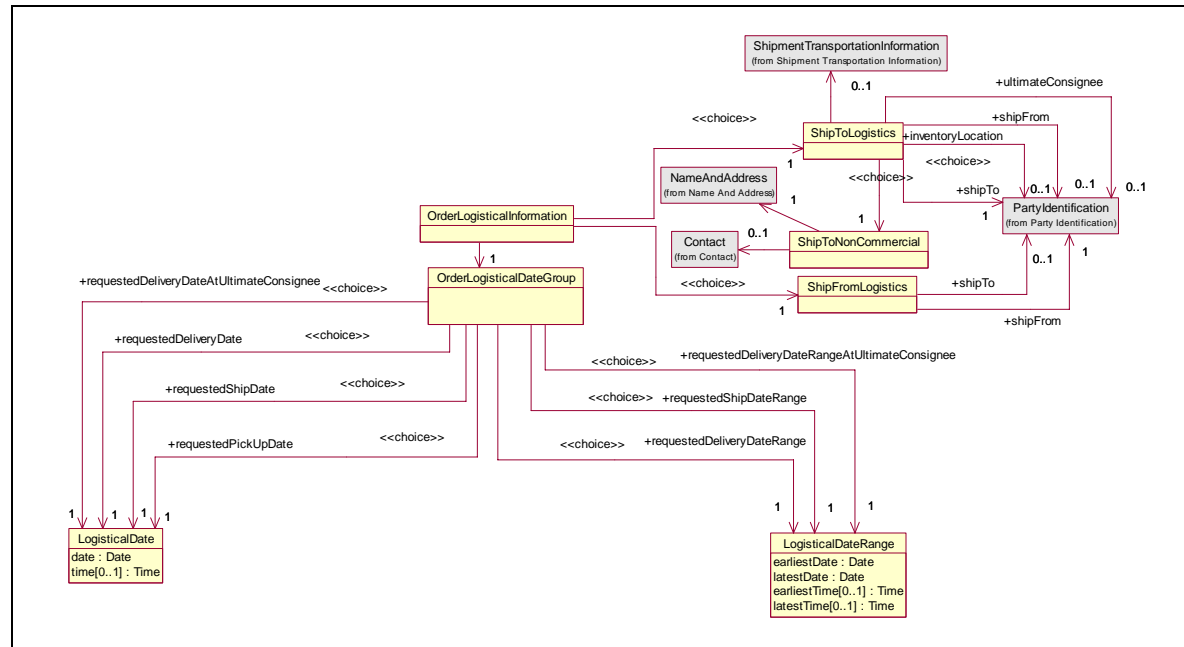

3.6.4. GDD Report: Order Logistical Information

Class (ABIE)	Attribute (BBIE)	Association (ASBIE)	Secondary Class	Definition	Multiplicity	Data Type Components	Related Requirements
LogisticalDate				Contains the information regarding the specific date and an optional time associated to the logistical information in the order.			
	date			The time at which an event occurs, expressed as a day	1..1	Code. Content Code List. Agenc. Identifier Code List. Agency Name. Text	
	time			An appointed, fixed, or customary moment or hour for something to happen, begin, or end in a specific role	0..1	Code. Content Code List. Agenc. Identifier Code List. Agency Name. Text	
LogisticalDateRange				Contains the information regarding the specific date ranges and an optional time ranges associated to the logistical information in the order.			
	earliestDate			Beginning day for a period	1..1	Code. Content Code List. Agenc. Identifier Code List. Agency Name. Text	
	earliestTime			Beginning time for a period	0..1	Code. Content Code List. Agenc. Identifier Code List. Agency Name. Text	

Class (ABIE)	Attribute (BBIE)	Association (ASBIE)	Secondary Class	Definition	Multiplicity	Data Type Components	Related Requirements
	latestDate			End of a period expressed as a day	1..1	Code. Content Code List. Agenc. Identifier Code List. Agency Name. Text	
	latestTime			End of a period expressed as time	0..1	Code. Content Code List. Agenc. Identifier Code List. Agency Name. Text	
OrderLogisticalDateGroup				Contains the choices to select various types of dates or date ranges associated to the order.			
		requestedDeliveryDate	LogisticalDate	Provides the date and optional time on which the goods are requested to be delivered.	1..1		
		requestedDeliveryDateAtUltimateConsignee	LogisticalDate	Provides the date and optional time on which the goods are requested to be delivered to the Ultimate Consignee.	1..1		
		requestedPickUpDate	LogisticalDate	Provides the date and optional time on which the goods are requested to be available for pickup at the seller's location.	1..1		
		requestedShipDate	LogisticalDate	Provides the date and optional time on which the goods are requested to be shipped or dispatched by the supplier.	1..1		
		requestedDeliveryDateRange	LogisticalDateRange	Provides the earliest and latest date ranges and the optional times on which the goods are requested to be delivered.	1..1		
		requestedDeliveryDateRangeAtUltimateConsignee	LogisticalDateRange	Provides the earliest and latest date ranges and the optional times on which the goods are requested to be delivered to the Ultimate Consignee.	1..1		
		requestedShipDateRange	LogisticalDateRange	Provides the earliest and latest date ranges and the optional times on which the goods are requested to be shipped or dispatch.	1..1		

Class (ABIE)	Attribute (BBIE)	Association (ASBIE)	Secondary Class	Definition	Multiplicity	Data Type Components	Related Requirements
OrderLogisticalInformation				Provides the earliest and latest date ranges and the optional times for the range of ship date associated to the order.			
		None	OrderLogisticalDateGroup	Contains the choices to select various types of dates or date ranges associated to the order.	1..1		
		None	ShipFromLogistics	Allows the identification of shipping details where the goods or services must be shipped from.	1..1		
		None	ShipToLogistics	Allows the identification of shipping details where the goods or services must be shipped to.	1..1		
ShipFromLogistics				Allows the identification of shipping details where the goods or services must be shipped from.			
		shipFrom	PartyIdentification	Identifies the origin location where the goods will be shipped.	1..1		
		shipTo	PartyIdentification	Identifies the destination location where the goods will be shipped.	0..1		
ShipToLogistics				Allows the identification of shipping details where the goods or services must be shipped to.			
		inventoryLocation	PartyIdentification	Identifies the location of merchandise or stock on hand.	0..1		
		None	ShipToNonCommercial	Contains the identification of the non commercial address and contact information.	1..1		BR3: BRAD Multi Shipment Order Enhancements Version 0.0.1
		None	ShipmentTransportationInformation	Contains the trade agreement reference number and the trade agreement reference date.	0..1		
		shipFrom	PartyIdentification	Identifies the origin location from which goods will be shipped.	0..1		
		shipTo	PartyIdentification	Identifies the destination location to which goods will be shipped.	1..1		
		ultimateConsignee	PartyIdentification	Identifies the final destination location to which goods will be shipped.	0..1		

Class (ABIE)	Attribute (BBIE)	Association (ASBIE)	Secondary Class	Definition	Multiplicity	Data Type Components	Related Requirements
ShipToNonCommercial				Allows the identification of the ship to non commercial's address and contact information. The destination location to which goods will be shipped when the ship-to party cannot be prealigned due to the business relationship. The Receiver of the items ordered is a non-Retail party that does not have a GLN, for example, ship directly to a consumer.			BR3: BRAD Multi Shipment Order Enhancements Version 0.0.1
		None	NameAndAddress	The destination location to which goods will be shipped when the ship-to party cannot be prealigned due to the business relationship. The Receiver of the items ordered is a non-Retail party that does not have a GLN, for example, ship directly to a consumer.	1..1		BR3: BRAD Multi Shipment Order Enhancements Version 0.0.1
		None	Contact	The destination contact information to which goods will be shipped when the ship to party cannot be prealigned due to the business relationship. The receiver of the items ordered is a non-Retail party that does not have a GLN, for example, ship directly to a consumer.	0..1		BR3: BRAD Multi Shipment Order Enhancements Version 0.0.1

3.6.5. Class Diagram: Order Party Information

Process Common Components: Order Common: Order Party Information

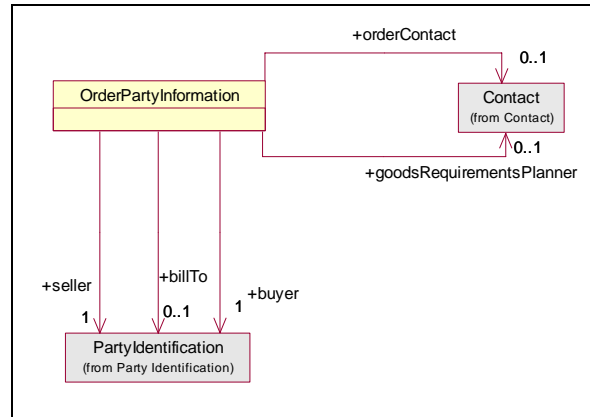

3.6.6. GDD Report: Order Party Information

Class (ABIE)	Attribute (BBIE)	Association (ASBIE)	Secondary Class	Official Dictionary Entry Name	Definition	Multiplicity	Related Requirements
OrderPartyInformation				Order_ Party Group. Details	Contains the information regarding the parties related in the order process.		
		goodsRequirementsPlanner	Contact	Order_ Party Group. Goods Requirements Planner_ Association. Contact	Contains the contact information of the person or department responsible for the planning at the buyer side.	0..1	
		orderContact	Contact	Order_ Party Group. Order Contact_ Association. Contact	Department or person responsible for issuing the order.	0..1	
		billTo	PartyIdentification	Order_ Party Group. Bill To. Party Identification	Identifies the party which receives invoice.	0..1	
		buyer	PartyIdentification	Order_ Party Group. Buyer. Party Identification	Identifies the party to which products or services is sold.	1..1	
		seller	PartyIdentification	Order_ Party Group. Seller. Party Identification	Identifies the party which sells products or services to a buyer.	1..1	

3.6.7. Class Diagram: Simple Order Line Item

Process Common Components: Order Common: Simple Order Line Item

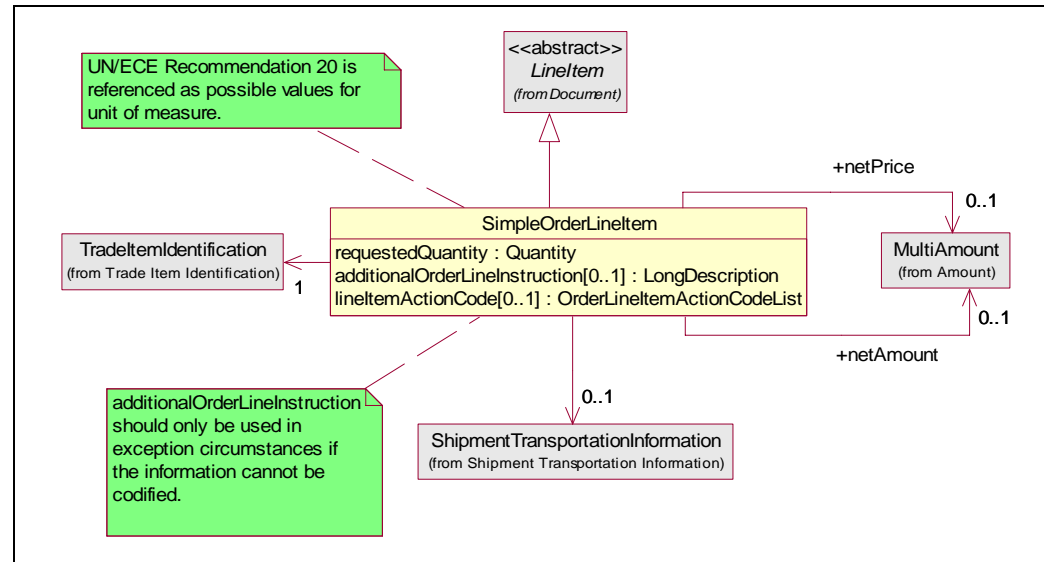

3.6.8. GDD Report: Simple Order Line Item

Class (ABIE)	Attribute (BBIE)	Association (ASBIE)	Secondary Class	Official Dictionary Entry Name	Definition	Multiplicity	Related Requirements
SimpleOrderLineItem				Simple_Purchase Order Line. Details	Specify the information related to each line item within the order.		
	additionalOrderLineInstruction				Additional Order Line Instruction captures information that has not been previously synchronised and is ad-hoc in nature. This field should only be used in exception circumstances if the information cannot be codified. Examples of Purchase Order Line: Use chrome hinges (not standard brass hinges) Please use <specified> timber Please prime (paint) door and jamb and pre-hang door	0..1	BR2: BRAD Multi Shipment Order Enhancements Version 0.0.1

Class (ABIE)	Attribute (BBIE)	Association (ASBIE)	Secondary Class	Official Dictionary Entry Name	Definition	Multiplicity	Related Requirements
	lineItemActionCode				Provides the activity required by the recipient on the line item of this order line item.	0..1	BR1: BRAD Multi Shipment Order Line Item Version 0.0.1
	requestedQuantity			Simple_Purchase Order Line. Requested_Quantity. Quantity	The quantity which has been requested.	1..1	
		None	LineItem	Simple_Purchase Order Line. Inheritance_Association. Line Item	Provides the line number associated to the Simple Order Line Item.	1..1	
		NetAmount	MultiAmount	Simple_Purchase Order Line. Net Amount. Multi-currency Amount	Identifies the net amount of the item.	0..1	
		netPrice	MultiAmount	Simple_Purchase Order Line. Net_Price. Multi-currency Amount	Identifies the net price of the item.	0..1	
		None	TradeItemIdentification	Simple_Purchase Order Line. Association. Trade Item Identification	Identifies the Trade Item with the Global Trade Item Number associated to the Simple Order Line Item.	1..1	
		None	ShipmentTransportationMode	Simple_Purchase Order Line. Association. Transportation Mode	Contains the identification of the carrier and mode associated with the transportation of the goods or services	0..1	

3.6.9. Class Diagram: Trade Agreement

Process Common Components: Order Common: Trade Agreement

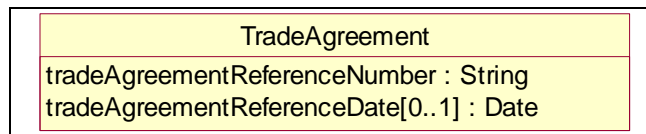

3.6.10. GDD Report: Trade Agreement

Class (ABIE)	Attribute (BBIE)	Association (ASBIE)	Secondary Class	Official Dictionary Entry Name	Definition	Multiplicity	Related Requirements
TradeAgreement				Trade Agreement. Details	Contains the trade agreement reference number and the trade agreement reference date.		
	tradeAgreementReferenceDate			Trade Agreement.Trade Agreement Reference Date.Date_ Date Time	Unique date identifying a trade agreement that the order is referring to.	0..1	
	tradeAgreementReferenceNumber			Trade Agreement. Number_ Reference. Text	Unique number identifying a trade agreement that the order is referring to. A number of different trading agreements may exist.	1..1	

3.7. Package Overview: Party Synchronisation Common

Process Common Components: Order Common: Party Synchronisation Common

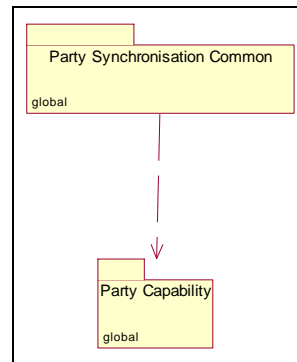

3.7.1. Class Diagram: Party Capability

Process Common Components: Party Synchronisation Common: Party Capability

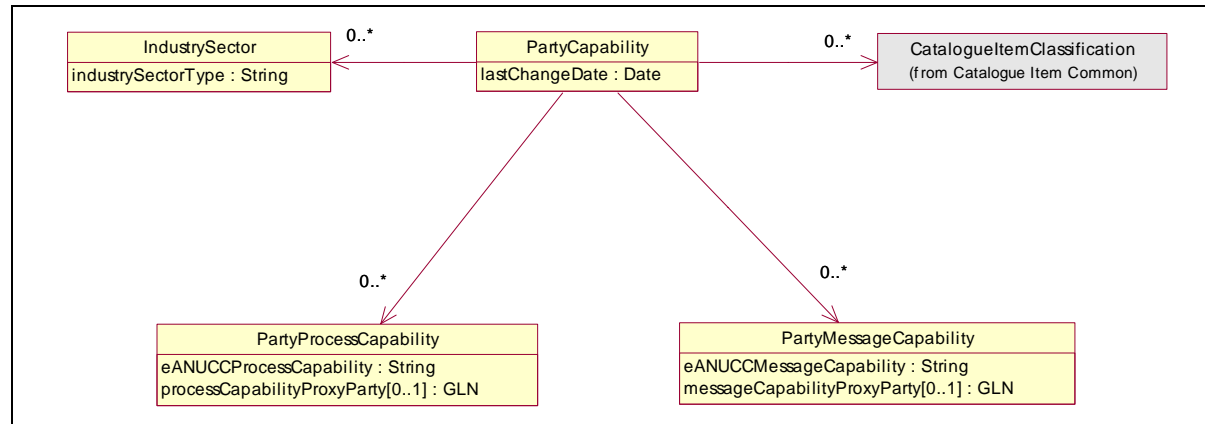

3.7.2. GDD Report: Party Capability

Class (ABIE)	Attribute (BBIE)	Association (ASBIE)	Secondary Class	Official Dictionary Entry Name	Definition	Multiplicity	Related Requirements
IndustrySector				Industry Sector. Details	Provides the industry sector information.		
	industrySectorType			Industry Sector. Type. Text	Name for the type of sector within industry as a means of classification	1..1	
PartyCapability				Party Capability. Details	Provides the party capability details.		
	lastChangeDate			Party Capability. Last Change Date. DOTW_ Date Time	Indicates the point in time where the information was last modified.	1..1	
			CatalogueItemClassification	Party Capability. Association. GPC_ Product Classification	This information on CatalogueItemClassification for PartyCapability.	0..*	

Class (ABIE)	Attribute (BBIE)	Association (ASBIE)	Secondary Class	Official Dictionary Entry Name	Definition	Multiplicity	Related Requirements
			IndustrySector	Party Capability. Association. Industry Sector	This information on IndustrySector for PartyCapability.	0..*	
			PartyMessageCapability	Party Capability. Association. Party Message Capability	This information on PartyMessageCapability for PartyCapability.	0..*	
			PartyProcessCapability	Party Capability. Association. Party Process Capability	This information on PartyProcessCapability for PartyCapability.	0..*	
PartyMessageCapability				Party Message Capability. Details	Provides the party message capability.		
	eANUCCMessageCapability			Party Message Capability. EANUCC_ Message Capability. Identifier	Definition not found.	1..1	
	messageCapabilityProxyParty			Party Message Capability. Proxy_ Party. Identifier	This party; identified by the Global Location Number-- The globally unique EAN.UCC System identification number for physical; functional; or legal entities. The Global Location Number uses the EAN/UCC-13 Data Structure.	0..1	
PartyProcessCapability				Party Process Capability. Details	Provides the party process capability information.		
	eANUCCProcessCapability			Party Process Capability. EANUCC_ Process Capability. Text	Definition not found.	1..1	
	processcapabilityProxyParty			Party Process Capability. Proxy_ Party. Text	A party uniquely identified by the Global Location Number-- The globally unique EAN.UCC System identification number for physical; functional; or legal entities. The Global Location Number uses the EAN/UCC-13 Data Structure.	0..1	

3.8. Package Overview: Pay Common

Process Common Components: Pay Common

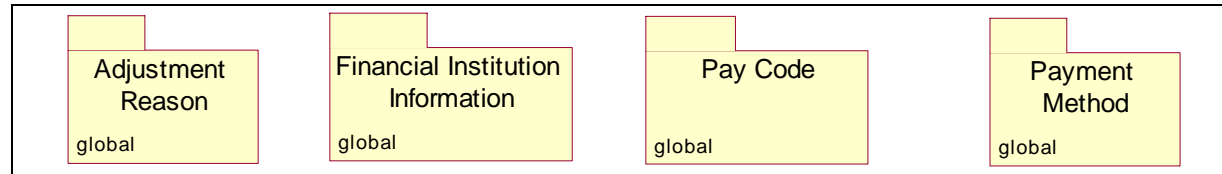

3.8.1. Class Diagram: Adjustment Reason

Process Common Components: Pay Common: Adjustment Reason

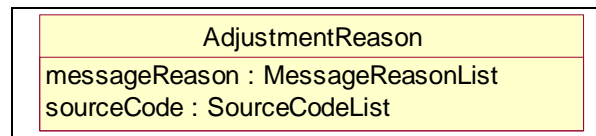

3.8.2. GDD Report: Adjustment Reason

Class (ABIE)	Attribute (BBIE)	Association (ASBIE)	Secondary Class	Official Dictionary Entry Name	Definition	Multiplicity	Related Requirements
AdjustmentReason				Adjustment Reason. Details	Provides the message reason and the source code for the adjustment.		
	messageReason			Adjustment Reason. Message Reason. Code	A description of a message reason selected from a code list.	1..1	
	sourceCode			Adjustment Reason. Source Code. Code	The identification of the source of the reason for an adjustment from a list of sources. Example: buyer or seller.	1..1	

3.8.3. Class Diagram: Financial Institution Information

Process Common Components: Pay Common: Financial Institution Information

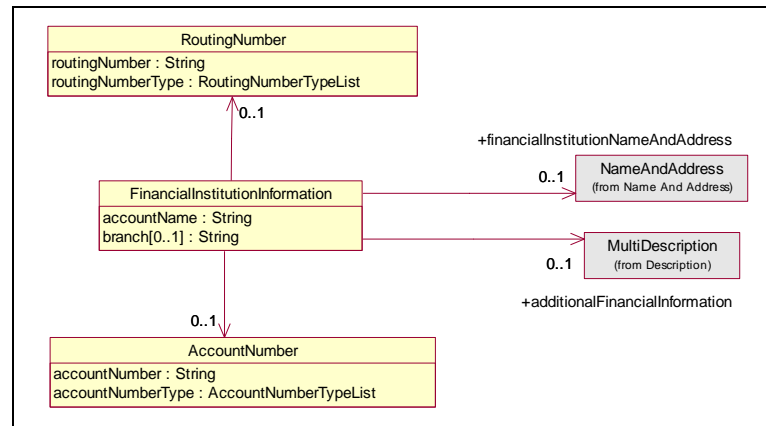

3.8.4. GDD Report: Financial Institution Information

Class (ABIE)	Attribute (BBIE)	Association (ASBIE)	Secondary Class	Official Dictionary Entry Name	Definition	Multiplicity	Related Requirements
AccountNumber				Financial_ Account. Details	This identifies the account number		
	accountNumber			Financial_ Account. Identification. Numeric	The identification of the account run by a financial institution.	1..1	
	accountNumberType			Financial_ Account. Account Number Type. Account Number Type_ Code	This will identify the type of the account number.	1..1	
FinancialInstitutionInformation				Financial Institution. Details	Information that is used for identifying the Financial Institution that will process the information.		
	accountName			Financial Institution. Account_ Name. Text	Name of account owner of originating transaction.	1..1	
	branch			Financial Institution. Branch_ Name. Text	Identification for a division; location of the account	0..1	

Class (ABIE)	Attribute (BBIE)	Association (ASBIE)	Secondary Class	Official Dictionary Entry Name	Definition	Multiplicity	Related Requirements
					holder's financial institution		
			AccountNumber	Financial Institution. Association. Financial_Account	Provides the Account Number for the Financial Institution.	0..1	
		additionalFinancialInformation	MultiDescription	Financial Institution. Description. Multi-language Description	A description used to provide any additional information about a financial institution.	0..1	
		financialInstitutionNameAndAddress	NameAndAddress	Financial Institution. Association. Party Address Group	The company name and address of a financial institution.	0..1	
			RoutingNumber	Financial Institution. Association. Financial_Routing	Provides the Routing Number for the Financial Institution.	0..1	
RoutingNumber				Financial_Routing. Details	Provides the routing information regarding the routing number and routing number type.		
	routingNumber			Financial_Routing. Number. Code	Number assigned to a transaction in financial routing between parties. The number is determined by and used in conjunction with the type of routing; e.g. SWIFT;ABA;CHIPS.	1..1	
	routingNumberType			Financial_Routing. Routing Number Type. Code	A predefined selection of code names used to identify the type of routing number used in the message. Also see Routing Number List.	1..1	

3.8.5. Class Diagram: Invoice Allowance Charge

Process Common Components: Pay Common: Invoice Allowance Charge

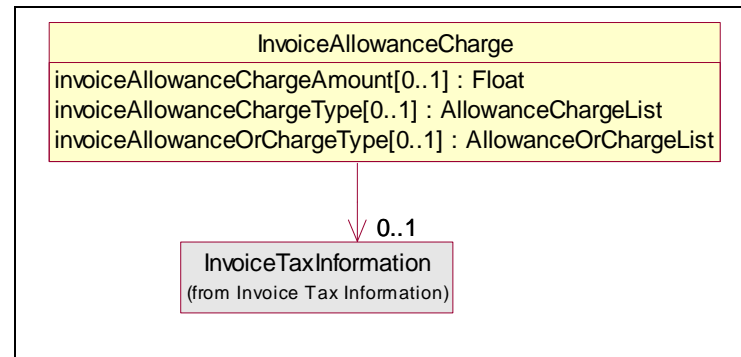

3.8.6. GDD Report: Invoice Allowance Charge

Class (ABIE)	Attribute (BBIE)	Association (ASBIE)	Secondary Class	Official Dictionary Entry Name	Definition	Multiplicity	Related Requirements
InvoiceAllowanceCharge				Invoice Allowance Charge. Details	The allowances and/or charges applicable to the invoice.		
	invoiceAllowanceChargeAmount			Invoice Allowance Charge. Invoice Allowance Charge Amount. Amount	Amount of allowance or charge applicable to the complete invoice.	0..1	
	invoiceAllowanceChargeType			Invoice Allowance Charge. Invoice Allowance Charge Type. Code	Code specifying the identification of an allowance or charge.	0..1	
	invoiceAllowanceOrChargeType			Invoice Allowance Charge. Invoice Allowance Or Charge Type. Code	Code specifying whether the amount is a deduction (allowance) or addition (charge) to the invoiced amount.	0..1	
			InvoiceTaxInformation	Invoice Allowance Charge. Association. Invoice Tax Information	Information about the tax applicable to the allowance and/or charge.	0..1	

3.8.7. Class Diagram: Invoice Party

Process Common Components: Pay Common: Invoice Party

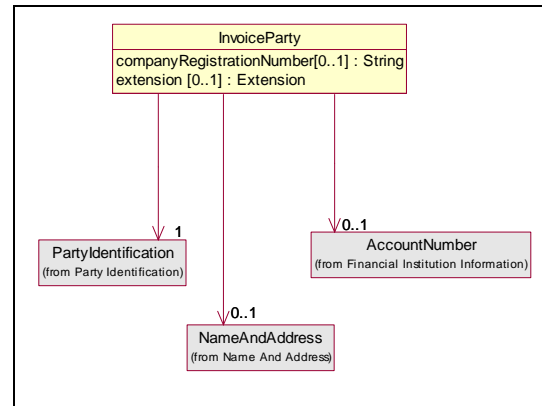

3.8.8. GDD Report: Invoice Party

Class (ABIE)	Attribute (BBIE)	Association (ASBIE)	Secondary Class	Official Dictionary Entry Name	Definition	Multiplicity	Related Requirements
InvoiceParty				Invoice Party. Details	Provides the unique identifier; name and address; and the account number information.		
	companyRegistrationNumber			Invoice Party. Company Registration Number. Text	Company registration number as legally required.	0..1	
	extension			Invoice Party. Extension. Extension_ Text	Extension Point	0..1	
			AccountNumber	Invoice Party. Association. Financial_ Account	Identification assigned by the account servicing bank to identify the account of the account owner.	0..1	
			NameAndAddress	Invoice Party. Association. Party Address Group	The specification of person and a physical location.	0..1	
			PartyIdentification	Invoice Party. Association. Party Identification	The identification of a party.	1..1	

3.8.9. Class Diagram: Invoice Tax Information

Process Common Components: Pay Common: Invoice Tax Information

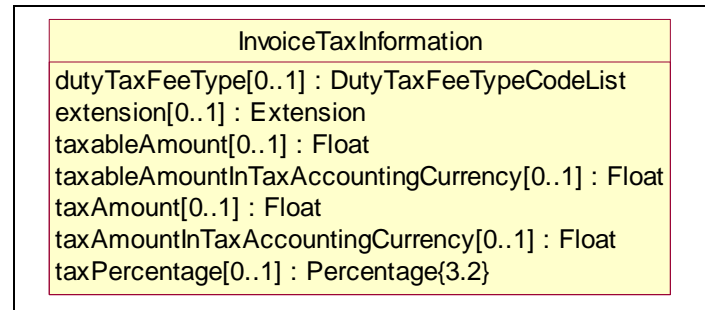

3.8.10. GDD Report: Invoice Tax Information

Class (ABIE)	Attribute (BBIE)	Association (ASBIE)	Secondary Class	Official Dictionary Entry Name	Definition	Multiplicity	Related Requirements
InvoiceTaxInformation				Invoice Tax Information. Details	Information about the taxes applicable to the invoice.		
	dutyTaxFeeType			Invoice Tax Information. Duty Tax Fee Type. Code	Type of duty; tax or fee.	0..1	
	extension			Invoice Tax Information. Extension. Extension_ Text	Extension Point	0..1	
	taxableAmount			Invoice Tax Information. Taxable Amount. Float_ Numeric	Amount on which a tax has to be applied.	0..1	
	taxableAmountInTaxAccountingCurrency			Invoice Tax Information. Taxable Amount In Tax Accounting Currency. Float_ Numeric	Amount on which a tax has been applied; where the monetary value is expressed in the currency used for tax accounting purposes.	0..1	
	taxAmount			Invoice Tax Information. Tax Amount. Float_ Numeric	Tax imposed by government or other official authority related to the weight/volume charge or valuation charge.	0..1	

Class (ABIE)	Attribute (BBIE)	Association (ASBIE)	Secondary Class	Official Dictionary Entry Name	Definition	Multiplicity	Related Requirements
	taxAmountInTaxAccountingCurrency			Invoice Tax Information. Tax Amount In Tax_ Accounting Currency. Float_ Numeric	Tax imposed by government or other official authority related to the weight/volume charge or valuation charge; and where the monetary value is expressed in the currency used for tax accounting purposes.	0..1	
	taxPercentage			Auto Generated	Tax Percentage is defined as a percentage or rate on the line item	0..1	[BRAD Invoice Enhancement V 0.0.1] {BR# 3}

3.8.11. Class Diagram: Line Item Additional Identification

Process Common Components: Pay Common: Line Item Additional Identification

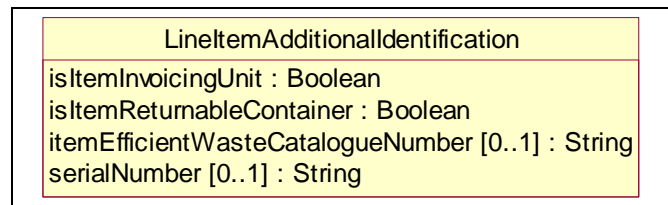

3.8.12. GDD Report: Line Item Additional Identification

Class (ABIE)	Attribute (BBIE)	Association (ASBIE)	Secondary Class	Official Dictionary Entry Name	Definition	Multiplicity	Related Requirements
LineltemAdditionalIdentification				Line Item Additional Identification. Details	Provides additional identification for line items within the European Invoice.		
	isItemInvoicingUnit			Line Item Additional Identification. Is Item Invoicing Unit. Identifier	Identifies whether or not an item at line item level within an invoice is the unit for invoicing.	1..1	
	isItemReturnableContainer			Line Item Additional Identification. Is Item Returnable Container. Identifier	Identifies whether or not the item in the invoice at line item level is a container which has to be returned to the shipper.	1..1	

Class (ABIE)	Attribute (BBIE)	Association (ASBIE)	Secondary Class	Official Dictionary Entry Name	Definition	Multiplicity	Related Requirements
	itemEfficientWasteCatalogueNumber			Line Item Additional Identification. Item Efficient Waste Catalogue Number. Text	Provides the identification of the item at line item level within the invoice as provided by the Efficient Waste Catalogue.	0..1	
	serialNumber			Line Item Additional Identification. Serial Number. Text	A number indicating the place in a series and used as a means of identification for an individual occurrence of an item	0..1	

3.8.13. Class Diagram: Line Item Packaging Information

Process Common Components: Pay Common: Line Item Packaging Information

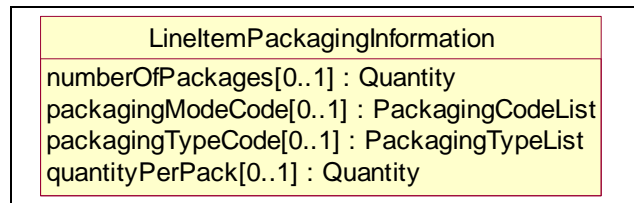

3.8.14. GDD Report: Line Item Packaging Information

Class (ABIE)	Attribute (BBIE)	Association (ASBIE)	Secondary Class	Official Dictionary Entry Name	Definition	Multiplicity	Related Requirements
LinItemPackagingInformation				Line Item Packaging Information. Details	Provides information on the packaging of items at the line item level within invoice.		
	numberOfPackages			Line Item Packaging Information. Number Of Packages. Quantity	Actual number of packages of the line item	0..1	
	packagingModeCode			Line Item Packaging Information. Packaging Mode code. Packaging_Code	Identifies the mode of packaging for the line item.	0..1	
	packagingTypeCode			Line Item Packaging Information. Packaging Type Code. Packaging Type_Code	Identifies the packaging type for the item.	0..1	
	quantityPerPack			Line Item Packaging Information. Quantity Per Pack. Quantity	The quantity contained in the pack.	0..1	

3.8.15. Class Diagram: Line Item Retail Information

Process Common Components: Pay Common: Line Item Retail Information

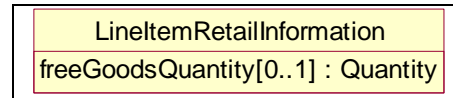

3.8.16. GDD: Line Item Retail Information

Class (ABIE)	Attribute (BBIE)	Association (ASBIE)	Secondary Class	Official Dictionary Entry Name	Definition	Multiplicity	Related Requirements
LineltemRetailInformation				Line Item Retail Information. Details	Provides additional retail related information for line items of an invoice.		
	freeGoodsQuantity			Line Item Retail Information. Free Goods Quantity. Quantity	A quantity which is delivered to the delivery party but is not charged. Such a free goods quantity is an allowance. The free quantity is not included in the invoiced quantity	0..1	

3.8.17. Class Diagram: Pay Code

Process Common Components: Pay Common: Pay Code

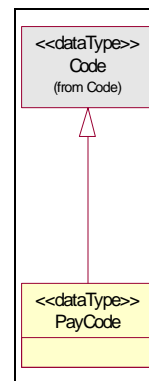

3.8.18. GDD Report: Pay Code

GDD Report is not applicable for DataType.

3.8.19. Class Diagram: Payment Discount

Process Common Components: Pay Common: Pay Code

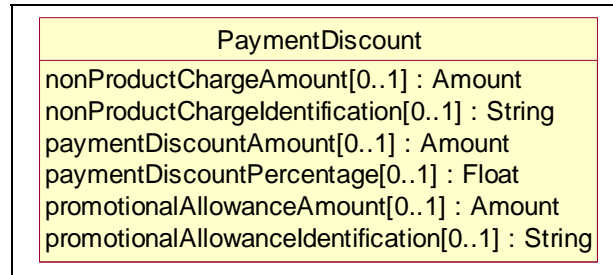

3.8.20. GDD Report: Payment Discount

Class (ABIE)	Attribute (BBIE)	Association (ASBIE)	Secondary Class	Official Dictionary Entry Name	Definition	Multiplicity	Related Requirements
PaymentDiscount				Payment Discount. Details	Additional information on discount on payments to be made for items mentioned in the Advance Remittance Notification.		
	nonProductChargeAmount			Payment Discount. Non Product Charge Amount. Amount	Amount; which is non product related; that is charged to the buyer by the seller.	0..1	
	nonProductChargeIdentification			Payment Discount. Non Product Charge Identification. Text	Description of the non-product related charge to the buyer by the seller.	0..1	
	paymentDiscountAmount			Payment Discount. Payment Discount Amount. Amount	Amount of currency received as a discount on the amount to be paid for the goods received by the buyer.	0..1	
	paymentDiscountPercentage			Payment Discount. Payment Discount Percentage. Float_Numeric	Discount on the amount to be paid for the goods received by the buyer; expressed in percents.	0..1	
	promotionalAllowanceAmount			Payment Discount. Promotional Allowance Amount. Amount	Allowance; due to a promotion; on the amount to be paid for the goods received by the buyer.	0..1	

Class (ABIE)	Attribute (BBIE)	Association (ASBIE)	Secondary Class	Official Dictionary Entry Name	Definition	Multiplicity	Related Requirements
	promotionalAllowanceIdentification			Payment Discount. Promotional Allowance Identification. Text	Description of the Allowance; due to a promotion; on the amount to be paid for the goods received by the buyer.	0..1	

3.8.21. Class Diagram: Payment Method

Process Common Components: Pay Common: Payment Method

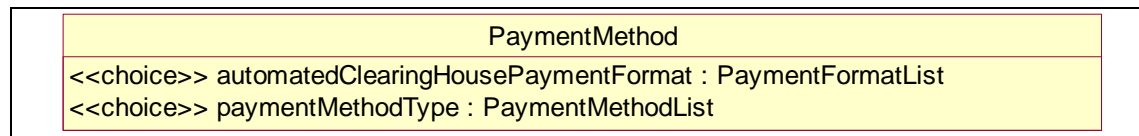

3.8.22. GDD Report: Payment Method

Class (ABIE)	Attribute (BBIE)	Association (ASBIE)	Secondary Class	Official Dictionary Entry Name	Definition	Multiplicity	Related Requirements
PaymentMethod				Pay_ Payment Method. Details	Provides the choice of payment method.		
	automatedClearingHousePaymentFormat			Pay_ Payment Method. Choice_ Automated Clearing House_ Format. Code	A predefined list of values that identify the format used when payment is made through an automated clearing house.	1..1	
	paymentMethodType			Pay_ Payment Method. Choice_ Payment Method. Code	A predefined list that identifies a method of payment. Also see Payment Method List.	1..1	

3.8.23. Class Diagram: VAT Invoice Party Extension

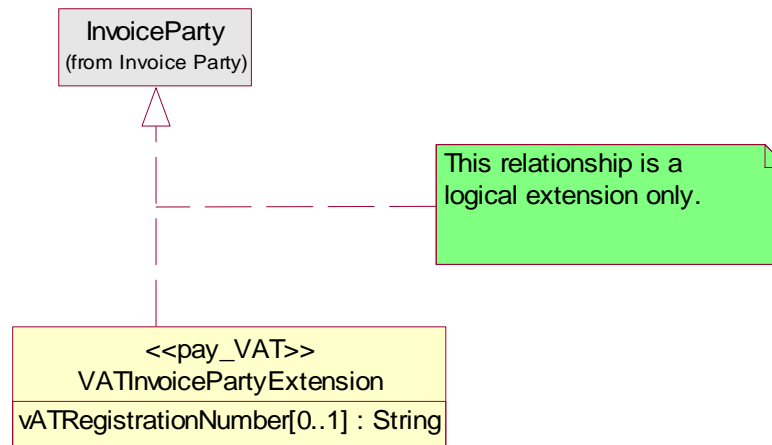

3.8.24. GDD Report: VAT Invoice Party Extension

Class (ABIE)	Attribute (BBIE)	Association (ASBIE)	Secondary Class	Official Dictionary Entry Name	Definition	Multiplicity	Related Requirements
VATInvoicePartyExtension				Pay_VAT_ Invoice Party. Details	None		
	vATRegistrationNumber			Pay_VAT_ Invoice Party. VAT_ Company Registration Number. Text	Unique number assigned by the relevant tax authority to identify a party for use in relation to Value Added Tax (VAT).	0..1	

3.8.25. Class Diagram: VAT Tax Information Extension

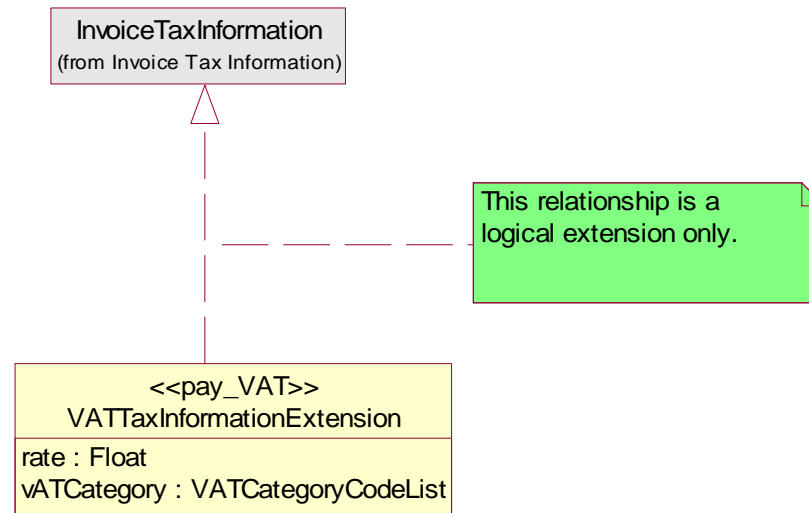

3.8.26. GDD Report: VAT Tax Information Extension

Class (ABIE)	Attribute (BBIE)	Association (ASBIE)	Secondary Class	Official Dictionary Entry Name	Definition	Multiplicity	Related Requirements
VATTaxInformationExtension				Pay_VAT_ Invoice Tax Information. Details	None		
	rate			Pay_VAT_ Invoice Tax Information. Rate. Float_Numeric	The actual rate of tax/duty.	1..1	
	vATCategory			Pay_VAT_ Invoice Tax Information. VAT_ Category. Code	Code specifying a duty or tax or fee category	1..1	

3.9. Package Overview: Plan Common

Process Common Components: Plan Common

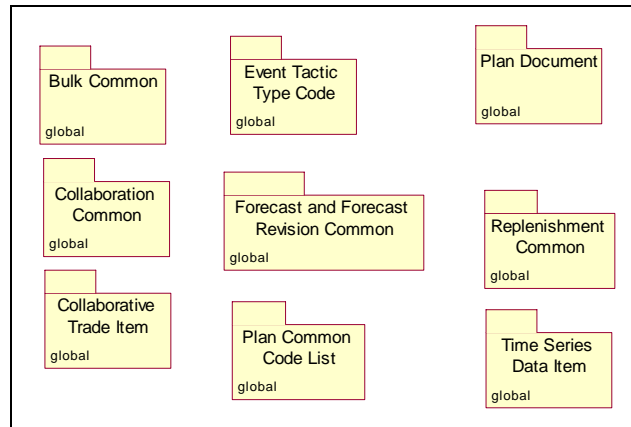

3.9.1. Class Diagram: Bulk Common

Process Common Components: Plan Common: Bulk Common

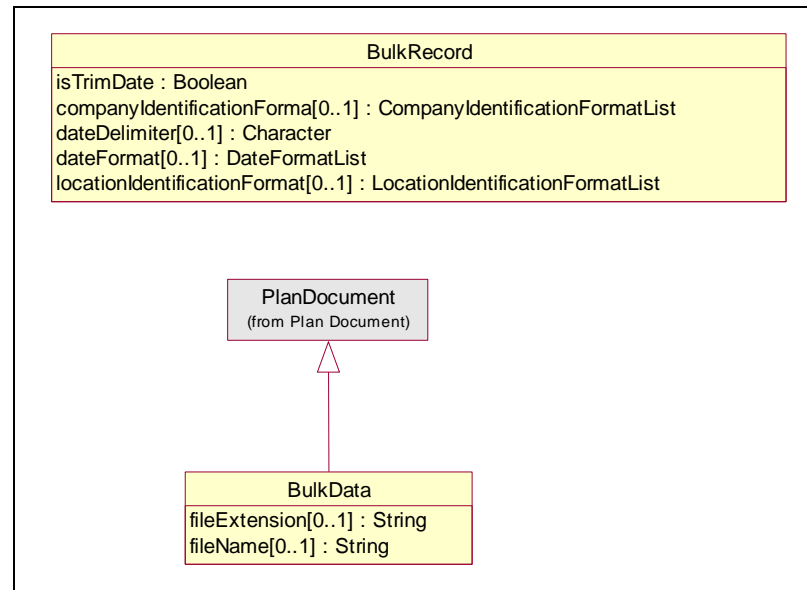

3.9.2. GDD Report: Bulk Common

Class (ABIE)	Attribute (BBIE)	Association (ASBIE)	Secondary Class	Official Dictionary Entry Name	Definition	Multiplicity	Related Requirements
BulkData				Bulk Data. Details	Provides the files associated to the bulk data.		
	fileExtension			Bulk Data. File Extension. Text	Extra identification of the file	0..1	
	fileName			Bulk Data. File Name. Text	Identification of the file	0..1	
			PlanDocument	Bulk Data. Inheritance_Association. Plan Document	This information on PlanDocument for BulkData.	1..1	
BulkRecord				Bulk Data Line. Details	The bulk record links company ID format(s); location ID format(s) and date format(s).		
	companyIdentificationFormat			Bulk Data Line. Company Identification Format. Code	Additional identification of the origin of the value	0..1	
	dateDelimiter			Bulk Data Line. Date Delimiter. Code	Single character to separate dates	0..1	
	dateFormat			Bulk Data Line. Date Format. Code	Lay out and sequence of the date in year; month and day	0..1	
	isTrimDate			Bulk Data Line. Is Trim Date. Code	Identification of whether or not excess characters in the dates should be trimmed.	1..1	
	locationIdentificationFormat			Bulk Data Line. Location Identification Format. Code	Additional identification of the origin of the value	0..1	

3.9.3. Class Diagram: Collaborative Trade Item

Process Common Components: Plan Common: Collaborative Trade Item

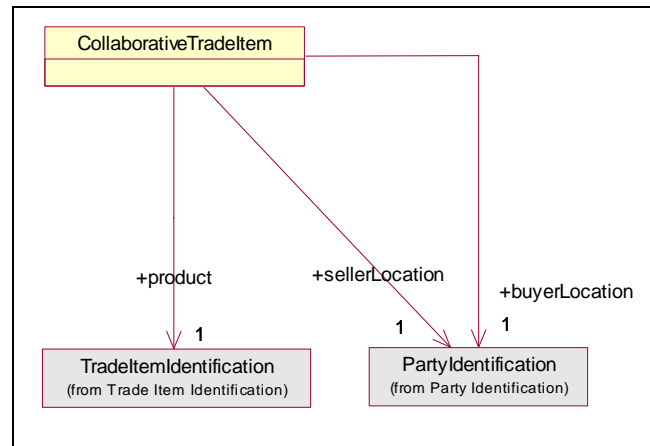

3.9.4. GDD Report: Collaborative Trade Item

Class (ABIE)	Attribute (BBIE)	Association (ASBIE)	Secondary Class	Official Dictionary Entry Name	Definition	Multiplicity	Related Requirements
CollaborativeTradeItem				Collaborative Item. Details	!! This external class originates in Plan Common and is a class that is used in more than one CPFR class diagram. Collaborative Trade Item identifies the product with the buyer and seller locations.		
		buyerLocation	PartyIdentification	Collaborative Item. Buyer Location. Party Identification	Location.Identification,Identifier: To specify any identifier related to this location such as a UNLOCODE, GS1 GLN, etc.	1..1	
		sellerLocation	PartyIdentification	Collaborative Item. Seller Location. Party Identification	Location.Identification,Identifier: To specify any identifier related to this location such as a UNLOCODE, GS1 GLN, etc.	1..1	
		product	TradeItemIdentification	Collaborative Item. Product. Trade Item Identification	A GTIN	1..1	

3.9.5. Class Diagram: Event Tactic Type Code

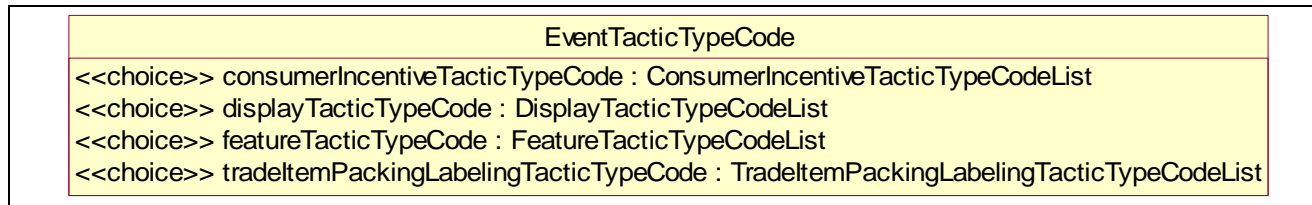

3.9.6. GDD Report: Event Tactic Type Code

Class (ABIE)	Attribute (BBIE)	Association (ASBIE)	Secondary Class	Official Dictionary Entry Name	Definition	Multiplicity	Related Requirements
EventTacticTypeCode				Event Tactic Type Code. Details	Describes a specific type of action or situation arranged by the Buyer or the Seller to promote a product or products.		
	<<choice>> consumerIncentiveTacticTypeCode			Event Tactic Type Code. Choice_ Consumer Incentive Tactic Type Code. ConsumerIncentiveTacticTypeCodeList_ Code	Not Available	1..1	
	<<choice>> displayTacticTypeCode			Event Tactic Type Code. Choice_ Display Tactic Type Code. Display Tactic_ Code	Not Available	1..1	
	<<choice>> featureTacticTypeCode			Event Tactic Type Code. Choice_ Feature Tactic Type Code. Feature Tactic_ Code		1..1	
	<<choice>> tradeItemPackingLabelingTacticTypeCode			Event Tactic Type Code. Choice_ Trade Item Packing Labeling Tactic Type Code. TradeItemPackingLabelingTacticTypeCode_ Code	Not Available	1..1	

3.9.7. Class Diagram: Forecast and Forecast Revision Common

Process Common Components: Plan Common: Forecast and Forecast Revision Common

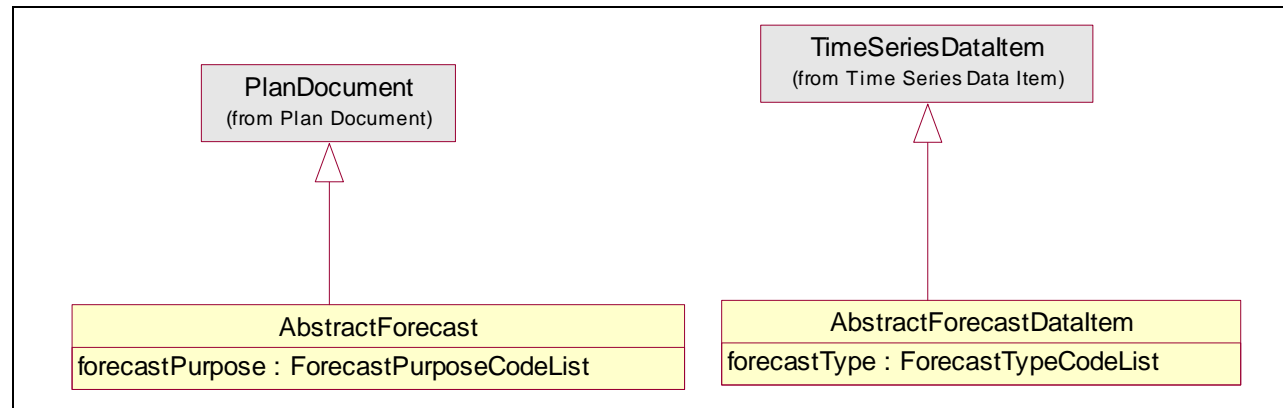

3.9.8. GDD Report: Forecast and Forecast Revision Common

Class (ABIE)	Attribute (BBIE)	Association (ASBIE)	Secondary Class	Official Dictionary Entry Name	Definition	Multiplicity	Related Requirements
AbstractForecast				Abstract_ Forecast. Details	!! This class merely links the Forecast Purpose Code List; Forecast Revision; and Plan Document. It has no attributes.		
	forecastPurpose			Abstract_ Forecast. Purpose. Code	Identification of the kind of forecast. Examples include; base and total.	1..1	
AbstractForecastDataItem				Abstract_ Forecast_ Time Stamped Trade Item Quantity. Details	!! This class merely links the Forecast Revision Data Item; Forecast Type Code List; and Time Series Data Item. The Abstract Forecast Data Item has no attributes.		
	forecastType			Abstract_ Forecast_ Time Stamped Trade Item Quantity. Association. Code	A code to identify the forecast. Examples include: order and sales.	1..1	
			TimeSeriesDataItem	Abstract_ Forecast_ Time Stamped Trade Item Quantity. Inheritance_ Association. Time Stamped Trade Item Quantity	This information on TimeSeriesDataItem for AbstractForecastDataItem.	1..1	

3.9.9. Class Diagram: Goods Requirements Line Item

Process Common Components: Plan Common: Goods Requirements Line Item

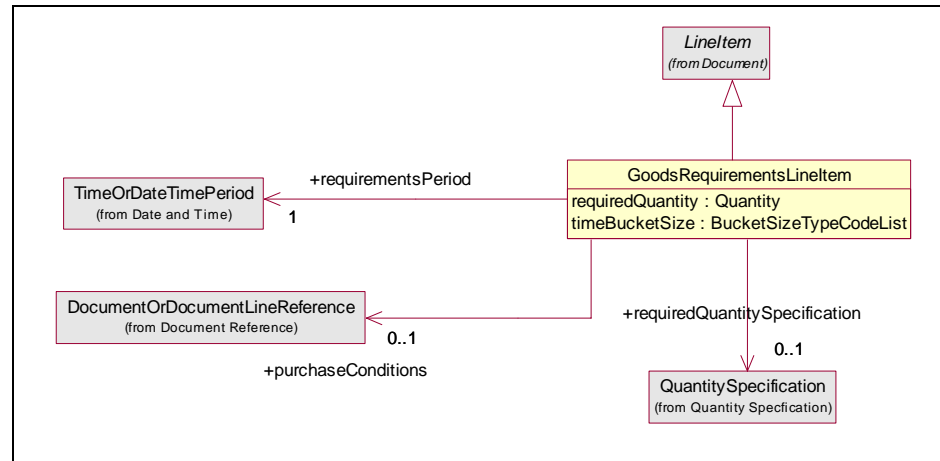

3.9.10. GDD Report: Goods Requirements Line Item

Class (ABIE)	Attribute (BBIE)	Association (ASBIE)	Secondary Class	Official Dictionary Entry Name	Definition	Multiplicity	Related Requirements
GoodsRequirementsLineItem				Goods Requirements Line Item. Details	Contains the required quantity for a specific time bucket.		
	requiredQuantity			Goods Requirements Line Item. Required_Quantity. Quantity	The number of units required.	1..1	
	timeBucketSize			Goods Requirements Line Item. Time Bucket Size. Bucket Size_Code	Contains a code describing the size of the requirements period.	1..1	
		purchaseConditions	DocumentOrDocumentLineReference	Goods Requirements Line Item. Purchase Conditions. Document Or Document Line Reference	Contains a reference to the commercial agreement under which the goods are supplied.	0..1	
			LineItem	Goods Requirements Line Item. Inheritance. Line Item	None	1..1	
		requiredQuantitySpecification	QuantitySpecification	Goods Requirements Line Item. Required Quantity Specification. Quantity Specification	Contains the cumulative quantity already received for the current time bucket.	0..1	
		requirementsPeriod	TimeOrDateTimePeriod	Goods Requirements Line Item. Requirements Period. Time Or Date Time Period	Contains the start and end dates and optionally start and end times of the time bucket.	1..1	

3.9.11. Class Diagram: Plan Document

Process Common Components: Plan Common: Plan Document

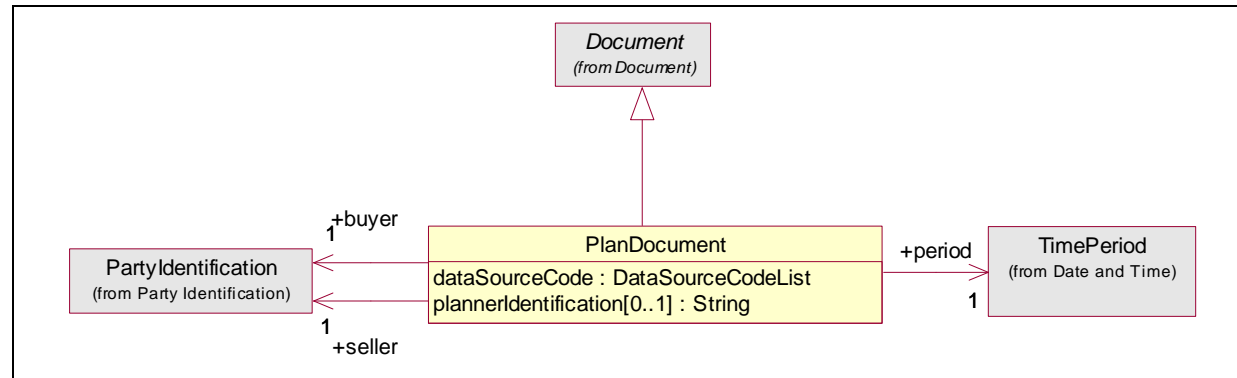

3.9.12. GDD Report: Plan Document

Class (ABIE)	Attribute (BBIE)	Association (ASBIE)	Secondary Class	Official Dictionary Entry Name	Definition	Multiplicity	Related Requirements
PlanDocument				Plan Document. Details	!! This external class originates in Plan Common and is a class that is used in more than one CPFR class diagram. Plan Document class is the GS1 System equivalent to CPFR Message class. This class has an attribute that provides the identification of the planner, identifies the source of the data, the time period for the document and the buyer and seller.		
	dataSourceCode			Plan Document. Data Source. Text	Indication of the partner who provides the information.	1..1	
	plannerIdentification			Plan Document. Planner Identification. Text	Identifies the individual or department that creates the planning document.	0..1	
		None	Document	Plan Document. Association. Electronic_ Document	This information on Document for PlanDocument.	1..1	
		buyer	PartyIdentification	Plan Document. Buyer. Party Identification	Party to which merchandise is sold	1..1	
		seller	PartyIdentification	Plan Document. Seller. Party Identification	Party, which sells products or services to a buyer.	1..1	
		period	TimePeriod Due	Plan Document. Period. Time Period	The duration of time series data that has a start date and an end date.	1..1	

3.9.13. Class Diagram: Quantity Specification

Process Common Components: Plan Common: Quantity Specification

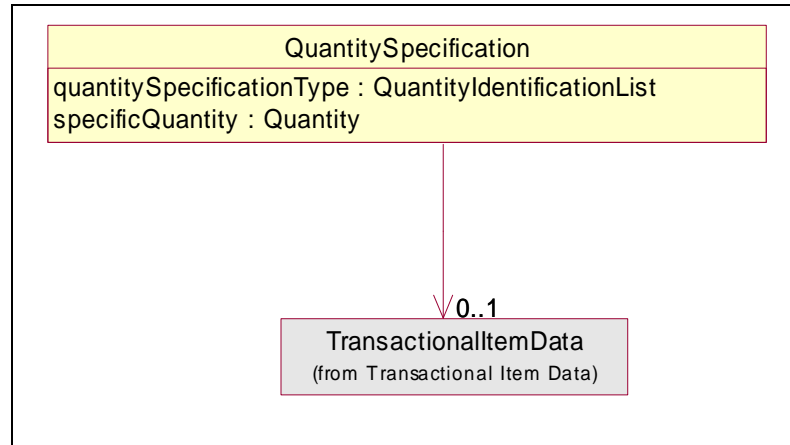

3.9.14. GDD Report: Quantity Specification

Class (ABIE)	Attribute (BBIE)	Association (ASBIE)	Secondary Class	Official Dictionary Entry Name	Definition	Multiplicity	Related Requirements
QuantitySpecification				Quantity Specification. Details	Information specifying details about goods planned to be produced and or delivered.		
	quantitySpecificationType			Quantity Specification. Quantity Specification Type. Code	Code specifying the type of planning information that is being provided.	1..1	
	specificQuantity			Quantity Specification. Specific Quantity. Quantity	Quantity of goods planned to be delivered or produced.	1..1	
			Transaction allItemData	Quantity Specification. Association. Transactional Item Data	Provides the transactional item data.	0..1	

3.9.15. Class Diagram: Replenishment Common

Process Common Components: Plan Common: Replenishment Common

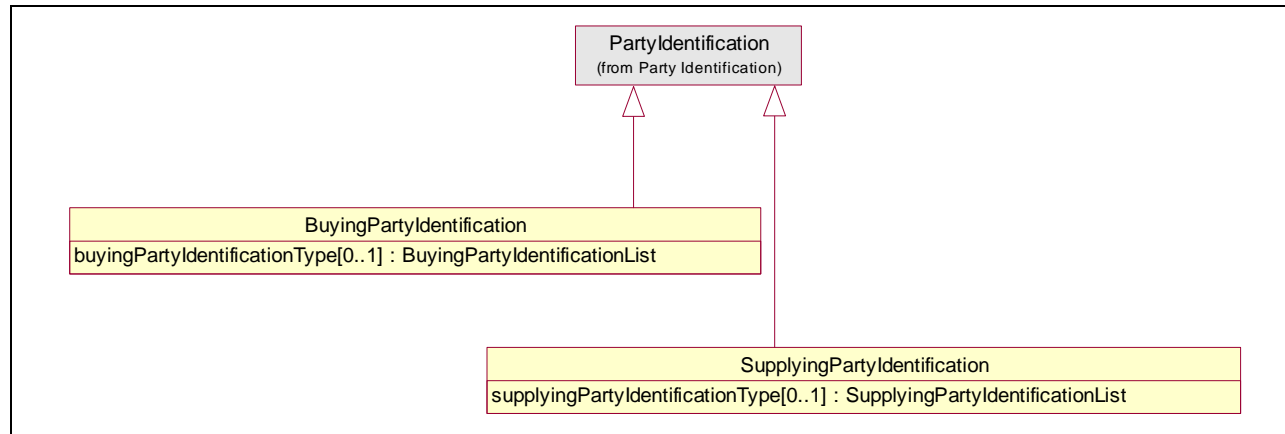

3.9.16. GDD Report: Replenishment Common

Class (ABIE)	Attribute (BBIE)	Association (ASBIE)	Secondary Class	Official Dictionary Entry Name	Definition	Multiplicity	Related Requirements
BuyingPartyIdentification				Buying_ Party Identification. Details			
	buyingPartyIdentificationType			Buying_ Party Identification. Identification Type. Code	Any party who issues a replenishment request (including inventory data if appropriate). Also see Buying Party Identification List.	0..1	
		None	PartyIdentification	Buying_ Party Identification. Inheritance_ Association. Party Identification	This information on PartyIdentification for BuyingPartyIdentification.	1..1	
SupplyingPartyIdentification				Supplying_ Party Identification. Details			
	supplyingPartyIdentificationType			Supplying_ Party Identification. Identification Type. Code	Any party who issues a replenishment proposal as a response to a replenishment request. Also see Supplying Party Identification List.	0..1	
		None	PartyIdentification	Supplying_ Party Identification. Inheritance_ Association. Party Identification	This information on PartyIdentification for SupplyingPartyIdentification.	1..1	

3.9.17. Class Diagram: Time Series Data Item

Process Common Components: Plan Common: Time Series Data Item

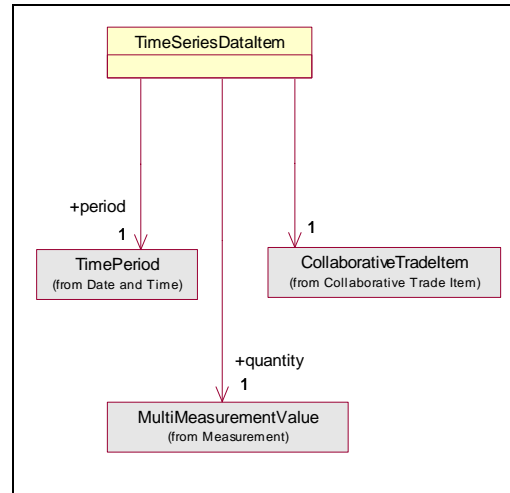

3.9.18. GDD Report: Time Series Data Item

Class (ABIE)	Attribute (BBIE)	Association (ASBIE)	Secondary Class	Official Dictionary Entry Name	Definition	Multiplicity	Related Requirements
TimeSeriesDataItem				Time Stamped Trade Item Quantity. Details	!! This external class originates in Plan Common and is a class that is used in more than one CPFR class diagram. This class links a Time Period, Measurement for the quantity involved, and to Collaborative Trade Item for the required product. It has no attributes.		
		None	CollaborativeTradeItem	Time Stamped Trade Item Quantity. Item. Collaborative Item	!! This external class originates in Plan Common and is a class that is used in more than one CPFR class diagram. Collaborative Trade Item identifies the product with the buyer and seller locations.	1..1	
		quantity	MultiMeasurementValue	Time Stamped Trade Item Quantity. Quantity. Multi-unit Measure	A numeric value associated with time series data for a specific date.	1..1	
		period	TimePeriod	Time Stamped Trade Item Quantity. Association. Date_ Time Period	The duration of time series data that has a start date and an end date.	1..1	

3.10. Package Overview: Price Common

Process Common Components: Price Common

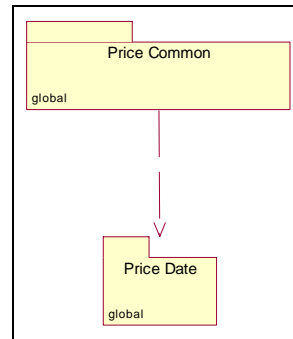

3.10.1. Class Diagram: Price Date

Process Common Components: Price Common : Price Date

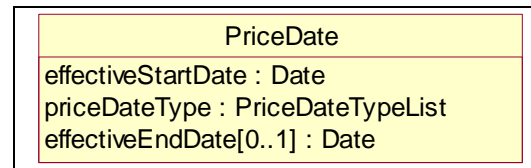

3.10.2. GDD Report: Price Date

Class (ABIE)	Attribute (BBIE)	Association (ASBIE)	Secondary Class	Official Dictionary Entry Name	Definition	Multiplicity	Related Requirements
PriceDate				Price_ Date Time Range. Details	Provides the effective dates for the effected price.		
	effectiveEndDate			Price_ Date Time Range. End_ Date. Code	The date as of which the price ceases to be applicable	0..1	
	effectiveStartDate			Price_ Date Time Range. Start_ Date. Code	The date as of which the price is applicable	1..1	
	priceDateType			Price_ Date Time Range. Price Data Type. Code	A code that identifies the type of date that applies to the price date.	1..1	

3.11. Package Overview: Process Common

Process Common Components: Process Common

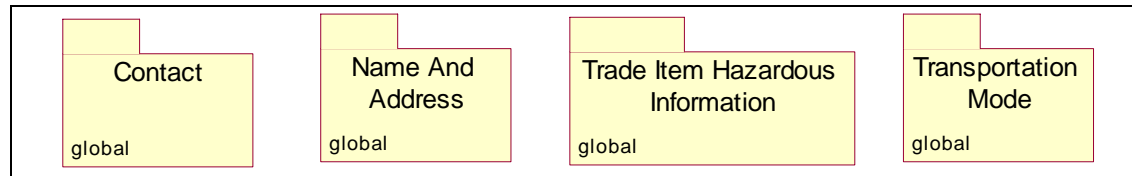

3.11.1. Class Diagram: Contact

Process Common Components: Process Common: Contact

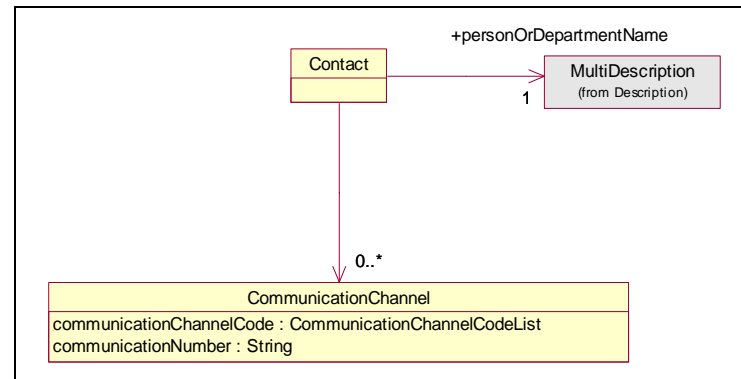

3.11.2. GDD Report: Contact

Class (ABIE)	Attribute (BBIE)	Association (ASBIE)	Secondary Class	Official Dictionary Entry Name	Definition	Multiplicity	Related Requirements
CommunicationChannel				Communication Channel. Details	The channel or manner in which a communication can be made, such as telephone or email.		
	CommunicationChannelCode			Communication Channel. Communication Channel. Text	Means used to communicate with another party.	1..1	
	communicationNumber			Communication Channel. Communication Number. Text	Number assigned to a specific means of communication.	1..1	

Class (ABIE)	Attribute (BBIE)	Association (ASBIE)	Secondary Class	Official Dictionary Entry Name	Definition	Multiplicity	Related Requirements
Contact				Contact. Details	The name and associated communication channel of a given party or organisation.		
		None	CommunicationChannel	Contact. Association. Communication Channel	This information on CommunicationChannel for Contact.	0..*	
		personOrDepartmentName	MultiDescription	Contact. Person or Department_ Name. Multi-language Description	The name of a department within this address. The name of the individual or department that can be contacted to provide additional information.	1..1	

3.11.3. Class Diagram: Currency Exchange Rate Information

Process Common Components: Process Common: Currency Exchange Rate Information

CurrencyExchangeRateInformation
currencyConversionFrom : ISO4217_Code
currencyConversionTo : ISO4217_Code
exchangeRate : Float
exchangeRateDate [0..1] : Date

3.11.4. GDD Report: Currency Exchange Rate Information

Class (ABIE)	Attribute (BBIE)	Association (ASBIE)	Secondary Class	Official Dictionary Entry Name	Definition	Multiplicity	Related Requirements
CurrencyExchangeRateInformation				Currency Exchange Rate Information. Details	Provides the currency exchange rate information. Rate at which one currency may be converted into another. Generally; one unit of the home currency is expressed in terms of another currency. For example; a North American bank may quote the exchange rate between the dollar and the Euro as the number of dollars needed to buy one Euro.		
	currencyConversionFrom			Currency Exchange Rate Information. Currency Conversion From_ ISO4217 Code. ISO_ Currency_ Code	ISO Code for the currency from which an amount is converted	1..1	

Class (ABIE)	Attribute (BBIE)	Association (ASBIE)	Secondary Class	Official Dictionary Entry Name	Definition	Multiplicity	Related Requirements
	currencyConversionTo			Currency Exchange Rate Information. Currency Conversion To_ ISO4217 Code. ISO_ Currency_ Code	ISO Code for the currency to which an amount is converted	1..1	
	exchangeRate			Currency Exchange Rate Information. Exchange Rate_ Float. Float_ Numeric	The price of one currency in terms of another; that is; the number of units of one currency that may be exchanged for one unit of another currency.	1..1	
	exchangeRateDate			Currency Exchange Rate Information.Exchange Rate Date.Date_ Date Time	The date as of which the currency exchange rate is valid.	0..1	

3.11.5. Class Diagram: Name and Address

Process Common Components: Process Common: Name And Address

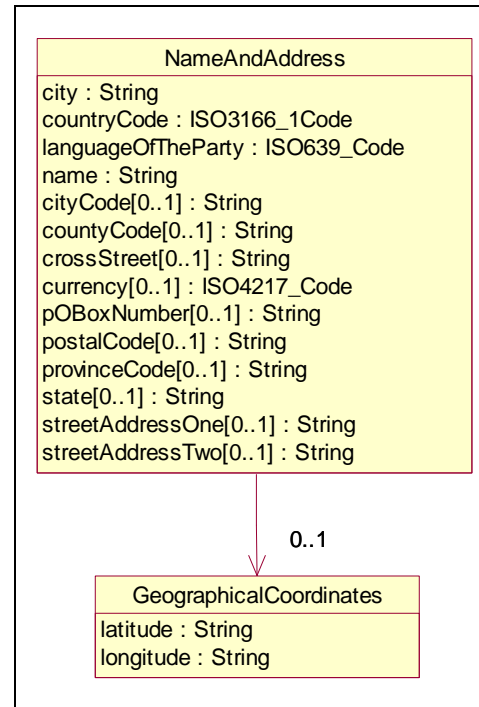

3.11.6. GDD Report: Name and Address

Class (ABIE)	Attribute (BBIE)	Association (ASBIE)	Secondary Class	Official Dictionary Entry Name	Definition	Multiplicity	Related Requirements
GeographicalCoordinates				Geographical Coordinate. Details	The longitude and latitude of a geographical location.		
	latitude			Geographical Coordinate. Latitude. Text	Angular distance North or South from the earths equator measured through 90 degrees.	1..1	
	longitude			Geographical Coordinate. Longitude. Text	The arc or portion of the earths equator intersected between the meridian of a given place and the prime meridian and expressed either in degrees or in time	1..1	
NameAndAddress				Party Address Group. Details	Each party will identify their party name and address. The Party information includes city; name; country code ISO 3166; and the language of the party ISO 639-1988. Optional address information may include: street address; P.O. Box number; state; province code; postal code; latitude; longitude; cross street; county code; city code.		
	city			Party Address Group. City. Text	An inhabited place of greater size; population; or importance than a town or village where the initial ship to location took place	1..1	
	cityCode			Party Address Group. City Code. Text	Identifier for a city; expressed as a short code rather than the full name	0..1	
	countryCode			Party Address Group. Country Code. Text	ISO 3661-1 Country Code associated with consignee address	1..1	
	countyCode			Party Address Group. County Code. Text	A code that identifies a county. A county is a territorial division in some countries; forming the chief unit of local administration. In the US; a county is a political and administrative division of a state.	0..1	
	crossStreet			Party Address Group. Cross Street. Text	A street intersecting a main street (usually at right angles) and continuing on both sides of it	0..1	
	currency			Party Address Group. Currency.	The ISO currency code of the currncy in which business is	0..1	

Class (ABIE)	Attribute (BBIE)	Association (ASBIE)	Secondary Class	Official Dictionary Entry Name	Definition	Multiplicity	Related Requirements
				Text	conducted with the current party (i.e. currency in which orders are placed and invoices are paid).		
	languageOfTheParty			Party Address Group. Language. Text	The ISO code of the language in which business with the current party is conducted.	1..1	
	name			Party Address Group. Name. Text	The name of the party expressed in text.	1..1	
	pOBoxNumber			Party Address Group. PO Box Number. Text	The number that identifies a PO box. A PO box is a box in a post office or other postal service location assigned to an organization where postal items may be kept.	0..1	
	postalCode			Party Address Group. Postal Code. Text	Code defining international postal zone code.	0..1	
	provinceCode			Party Address Group. Province Code. Text	Free form text for State/Province.	0..1	
	state			Party Address Group. State. Text	One of the consitiuent units of a nation having a federal government.	0..1	
	streetAddressOne			Party Address Group. Street Address One. Text	The first free form line of an address; This first part is printed on paper as the first line below the name. For example; the name of the street and the number in the street or the name of a building.	0..1	
	streetAddressTwo			Party Address Group. Street Address Two. Text	The second free form line of an address; This second part is printed on paper as the second line below the name. The second free form line complements the first free form line to locate the party e.g. floor number; name of a building; suite number o	0..1	
			GeographicalCoordinates	Party Address Group. Association. Geographical Coordinate	This information on GeographicalCoordinates for NameAndAddress.	0..1	

3.11.7. Class Diagram: Trade Item Hazardous Information

Process Common Components: Process Common: Trade Item Hazardous Information

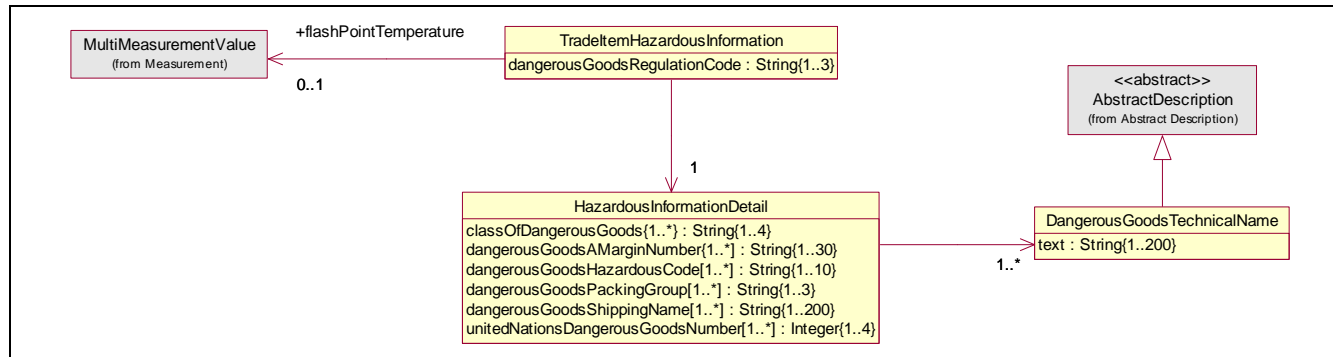

3.11.8. GDD Report: Trade Item Hazardous Information

Class (ABIE)	Attribute (BBIE)	Association (ASBIE)	Secondary Class	Official Dictionary Entry Name	Definition	Multiplicity	Related Requirements
DangerousGoodsTechnicalName				Dangerous Goods Technical Name. Details	Provides the dangerous goods technical information.		
	text			Dangerous Goods Technical Name. Text. {1..200}_Text	The dangerous goods technical name represented in textual format.	1..1	
HazardousInformationDetail				Hazardous Item Description Group. Details	Provides the details of hazardous information.		
	classOfDangerousGoods			Hazardous Item Description Group. Hazardous Goods_Class . Identifier	Dangerous goods classification of the trade item. There are 9 danger classes; some classes are further subdivided into subclasses. "Class" number explains in general terms the nature and properties of the goods and serves to classify them together in terms of their most significant risk.	1..*	
	dangerousGoodsAMarginNumber			Hazardous Item Description Group. Hazardous Goods_A Margin Number. Identifier	Information; whether for the base trade item or further packaging trade item a dangerous goods a-margin number does exist in the European dangerous goods agreements (and in the respective national dangerous goods legislation); thus facilitations for the transport of defined limited quantity by road or rail are possible or not. If they are possible; they must be indicated; whether they are used by the data supplier.	1..*	

Class (ABIE)	Attribute (BBIE)	Association (ASBIE)	Secondary Class	Official Dictionary Entry Name	Definition	Multiplicity	Related Requirements
	dangerousGoodsHazardousCode			Hazardous Item Description Group. Hazardous Goods_Hazard. Identifier	Dangerous goods hazard ID number; which must be applied to the vehicle; when transporting this trade item (dangerous good) by road or rail; to inform the police; the fire brigade and others in case of an accident about the kind of danger caused by the cargo.	1..*	
	dangerousGoodsPackingGroup			Hazardous Item Description Group. Hazardous Goods_Packing Group. Identifier	Identifies the degree of risk these dangerous goods present during transport according to IATA/IMDG/ADR/RID regulations.	1..*	
	dangerousGoodsShippingName			Hazardous Item Description Group. Hazardous Goods_Name. Identifier	Shipping name of the trade item (dangerous goods). The recognized agencies (see dangerousGoodsRegulationsCodes); in their regulations; provide a list of all acceptable proper shipping names.	1..*	
	unitedNationsDangerousGoodsNumber			Hazardous Item Description Group. United Nations_Class. Identifier	The four-digit number assigned by the United Nations Committee of Experts on the Transport of Dangerous Goods to classify a substance or a particular groups of substances. Abbreviation: UNDG Number.	1..*	
			DangerousGoodsTechnicalName	Hazardous Item Description Group. Association. Dangerous Goods Technical Name	Provides the dangerous goods technical name.	1..*	
TradeItemHazardousInformation				Hazardous Goods. Details	!! This reusable class is part of the Trading Partner Neutral Trade Item Information Class.		
	dangerousGoodsRegulationCode			Hazardous Goods. Regulation. Identifier	An indication of the classification system(s) of dangerous goods and/or the Agency(ies) responsible for it.	1..1	
			HazardousInformationDetail	Hazardous Goods. Association. Hazardous Item Description Group	This information on HazardousInformationDetail for TradeItemHazardousInformation.	1..1	
		flashPointTemperature	MultiMeasurementValue	Hazardous Goods. Flash Point_Temperature. Multi-unit Measure	The lowest temperature at which a substance gives off a sufficient vapor to support combustion. This uses a measurement consisting of a unit of measure and value.	0..1	

3.11.9. Class Diagram: Shipment Transportation Information

Process Common Components: Process Common: Shipment Transportation Information

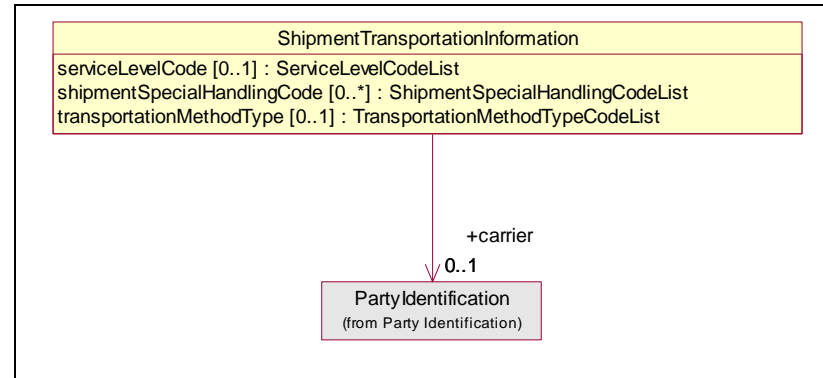

3.11.10. GDD Report: Shipment Transportation Information

Class (ABIE)	Attribute (BBIE)	Association (ASBIE)	Secondary Class	Official Dictionary Entry Name	Definition	Multiplicity	Related Requirements
ShipmentTransportationInformation				Shipment Transportation Information. Details	When shipments from the Supplier to a Buyer or other non-Retail party are made, the Buyer may stipulate the method of shipment and/or the carrier to be used for the shipment.		
	serviceLevelCode			Shipment Transportation Information. Code. Service Level_ Code	Allows to specify the service level of shipment - in addition to designating the transportation method.	0..1	
	shipmentSpecialHandlingCode			Shipment Transportation Information. Special Handling Code. Shipment Special Handling_ Code	Allows to specify special handling instructions - in addition to designating the transportation method.	0..*	
	transportationMethodType			Shipment Transportation Information. Method Type. Transportation Method Type Code List_ Code	The shipment designation. Examples: FedEx, UPS, air, ground, etc.	0..1	
		carrier	BuyingPartyIdentification	Shipment Transportation Information. Carrier_ Association. Buying_ Party Identification	Allows to specify the carrier to be used for the shipment.	0..1	

3.11.11. Class Diagram: External File Link

Process Common Components: Process Common: External File Link

ExternalFileLink
contentDescription [0..1] : Description fileFormatDescription [0..1] : Description fileFormatName [0..1] : String {1..10} fileName [0..1] : String {1..70} uniformResourceIdentifier [0..1] : String{1..512}

3.11.12. GDD Report: External File Link

Class (ABIE)	Attribute (BBIE)	Association (ASBIE)	Secondary Class	Official Dictionary Entry Name	Definition	Multiplicity	Related Requirements
ExternalFileLink				External File Link. Details	Information specifying a link to a file external to the message itself.		
	contentDescription			External File Link. Content Description. Text	Free form description of the content of the file.	0..1	
	fileFormatDescription			External File Link. File Format Description. Text	Free form description of the format of the file.	0..1	
	fileFormatName			External File Link. File Format Name. Text	The name of the file format. Examples: PDF; JPEG; BMP	0..1	
	fileName			External File Link. File Name. Text	The name of the file that contains the external information.	0..1	
	uniformResourceIdentifier			External File Link. Uniform Resource Identifier. Text	Simple text string that refers to a resource on the internet; URIs may refer to documents; resources; people; ...	0..1	

3.12. Package Overview: Price Common

Process Common Components: Response

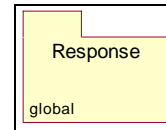

3.12.1. Class Diagram: Response

Process Common Components: Response

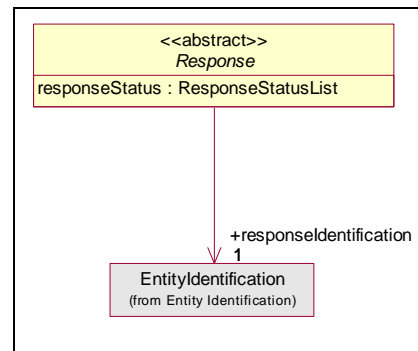

3.12.2. GDD Report: Response

Class (ABIE)	Attribute (BBIE)	Association (ASBIE)	Secondary Class	Official Dictionary Entry Name	Definition	Multiplicity	Related Requirements
Response				Response. Details			
	responseStatus			Response. Status. Code	Indicates whether a response was accepted or not, or whether it was modified.	1..1	
		responselidentification	EntityIdentification	Response. Identification. Entity Identification	The identification of the response document.	1..1	

3.13. Package Overview: Terms

Process Common Components: Terms

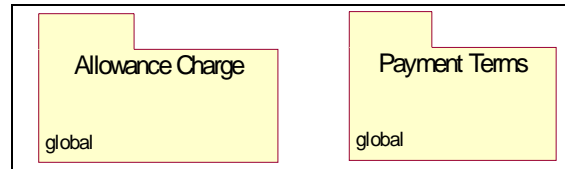

3.13.1. Class Diagram: Allowance Charge

Process Common Components: Terms: Allowance Charge

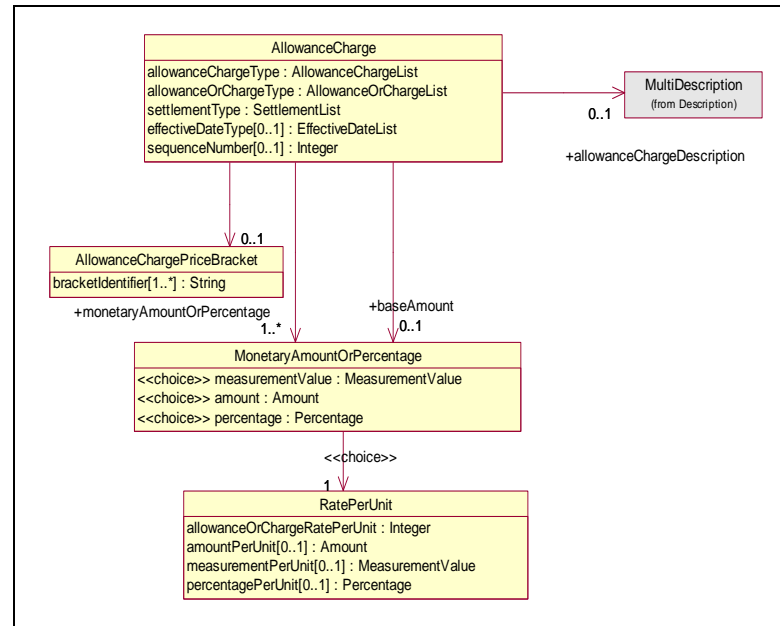

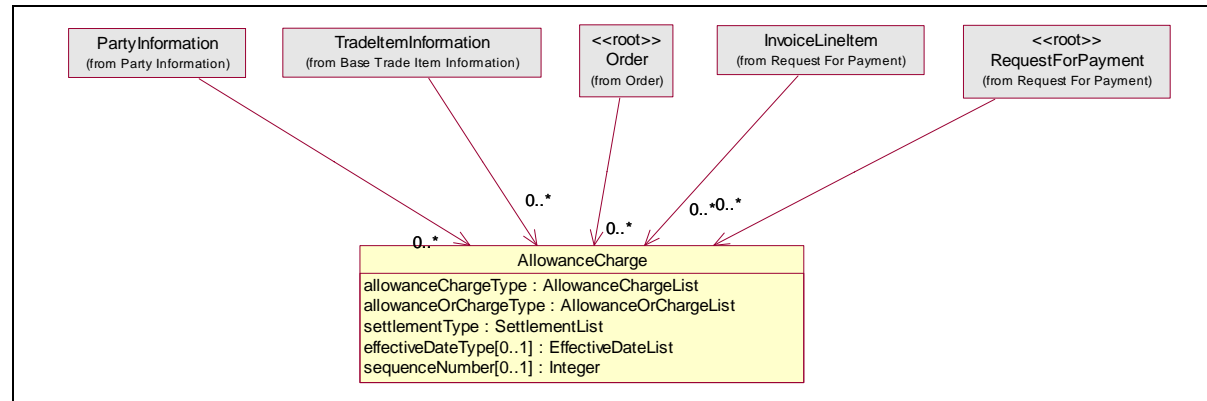

3.13.2. GDD Report: Allowance Charge

Class (ABIE)	Attribute (BBIE)	Association (ASBIE)	Secondary Class	Official Dictionary Entry Name	Definition	Multiplicity	Related Requirements
AllowanceCharge				Allowance Charge. Details	Specifies allowances and charges specified to either the entire message or to individual line items contained in the message.		
	allowanceChargeType			Allowance Charge. Allowance Charge_ Type. Indicator	The identification of an allowance charge selected from a predefined list. Also see Allowance Charge List.	1..1	
	allowanceOrChargeType			Allowance Charge. Allowance Or Charge_ Type. Indicator	The identification of either an allowance or a charge selected from the allowance or charge list.	1..1	
	effectiveDateType			Allowance Charge. Effective_ Date Type. Indicator	The date on which this event is effective	0..1	
	sequenceNumber			Allowance Charge. Sequence Number. Integer_ Numeric	A unique number used to indicate the order in which the allowances or charges are to be calculated.	0..1	
	settlementType			Allowance Charge. Settlement_ Type. Indicator	The identification of a type of settlement selected from a predetermined list of types. Also see Allowance Charge List.	1..1	
		None	AllowanceChargePriceBracket	Allowance Charge. Association. Allowance Charge_ Price Bracket	This information on AllowanceChargePriceBracket for AllowanceCharge.	0..1	
		None	MonetaryAmountOrPercentage	Allowance Charge. Monetary Amount Or Percentage. Amount Percent Group	The amount of the allowance charge expressed as a measurement value, amount or percent.	1..*	

Class (ABIE)	Attribute (BBIE)	Association (ASBIE)	Secondary Class	Official Dictionary Entry Name	Definition	Multiplicity	Related Requirements
		baseAmount	MonetaryAmountOrPercentage	Allowance Charge. Base Amount. Amount Percent Group	The amount of the allowance charge expressed as a measurement value, amount or percent.	0..1	
		allowanceChargeDescription	MultiDescription	Allowance Charge. Allowance Charge_ Description. Multi-language Description	A text explanation of the allowance or charge. description is optional	0..1	
AllowanceChargePriceBracket				Allowance Charge_ Price Bracket. Details			
	bracketIdentifier			Allowance Charge_ Price Bracket. Description. Indicator	A code that identifies a price bracket.	1..*	
MonetaryAmountOrPercentage				Amount Percent Group. Details			
	amount			Amount Percent Group. Choice_ Amount. Numeric	used to indicate an allowance or charge applied against a given other amount	1..1	
	measurementValue			Amount Percent Group. Choice_ Measurement. Numeric	used to indicate an allowance or charge applied against a given measurement or quantity	1..1	
	percentage			Amount Percent Group. Choice_ Percentage. Numeric	Allowance and charges can be expressed in different ways. By using percentage, they are expressed as a percentage of another amount, e.g. the base amount.	1..1	
		None	RatePerUnit	Amount Percent Group. Choice_ Association. Allowance Charge Unit Rate	This information on RatePerUnit for MonetaryAmountOrPercentage.	1..1	
RatePerUnit				Allowance Charge Unit Rate. Details	The rate per unit is specified as a monetary amount per unit, as a measurement such as a quantity, weight, or dimension, or as a percentage per unit.		
	allowanceOrChargeRatePerUnit			Allowance Charge Unit Rate. Value. Numeric	Allowance/charge per unit expressed as a figure without decimals.	1..1	
	amountPerUnit			Allowance Charge Unit Rate. Value. Numeric	Allowance/charge per unit expressed as an amount.	0..1	
	measurementPerUnit			Allowance Charge Unit Rate. Value. Numeric	The allowance/charge rate per unit defined as a measurement. E.g. per ton	0..1	
	percentagePerUnit			Allowance Charge Unit Rate. Value. Numeric	Allowance/charge per unit expressed as a percentage.	0..1	

3.13.3. Class Diagram: Payment Terms

Process Common Components: Terms: Payment Terms

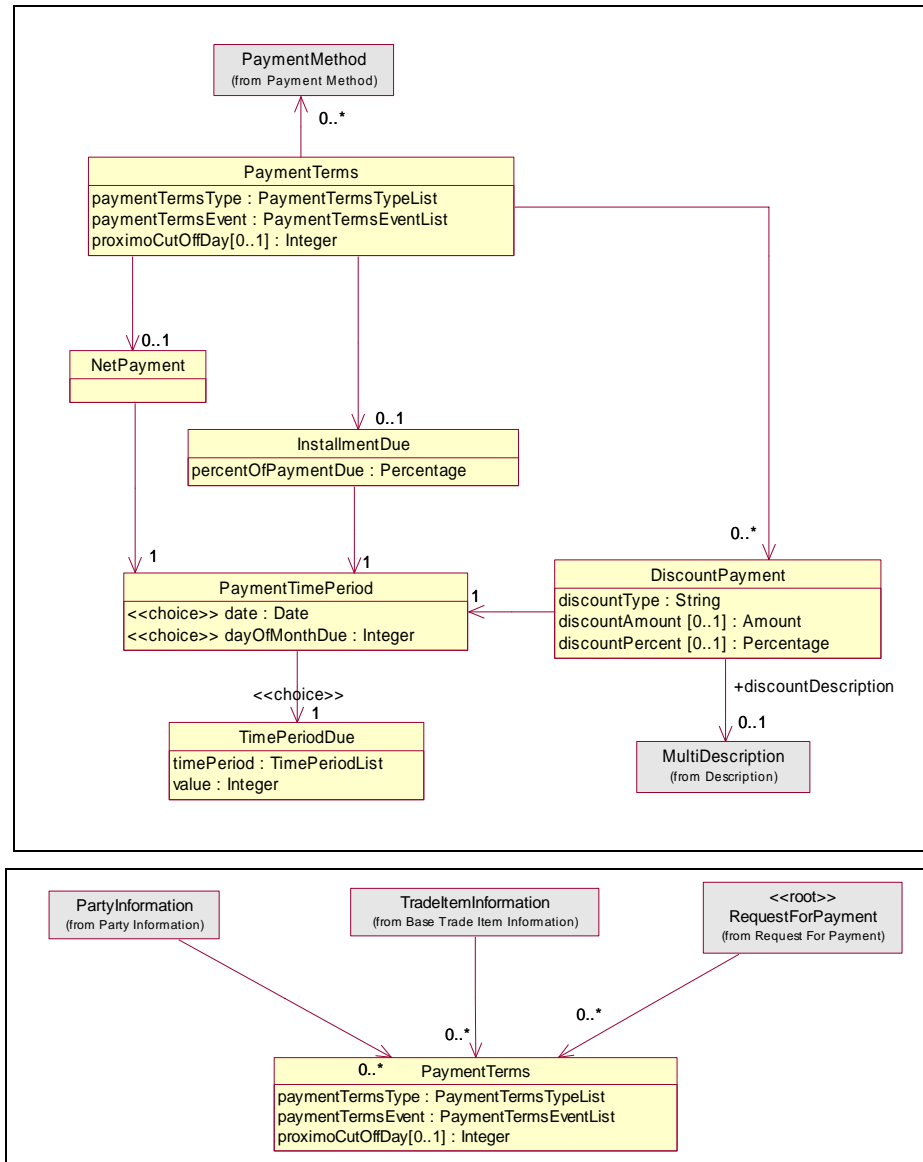

3.13.4. GDD Report: Payment Terms

Class (ABIE)	Attribute (BBIE)	Association (ASBIE)	Secondary Class	Official Dictionary Entry Name	Definition	Multiplicity	Related Requirements
DiscountPayment				Discount_ Payment Due. Details	This class is used to describe the amount for a discounted payment. Zero or more discounts may be specified using this class. The discount amount is expressed as a percent and is based on the number of days by which the payment must be made to earn the discount. For each discount, a time period is required to specify the percent discount earned.		
	discountAmount			Discount_ Payment Due. Discount Amount. Amount	The deduction represented in amount format.	0..1	
	discountPercent			Discount_ Payment Due. Percent Of Payment. Numeric	The deduction represented in percentage.	0..1	
	discountType			Discount_ Payment Due. Discount Type. Numeric	A code that specifies the type of payment discount.	1..1	
		discountDescription	MultiDescription	Discount_ Payment Due. Description. Multi-language Description	A text field describing the discount.	0..1	
		None	PaymentTimePeriod	Discount_ Payment Due. Terms Discount Due. Payment Due	This information on PaymentTimePeriod for DiscountPayment.	1..1	
InstallmentDue				Installment_ Payment Due. Details	This class is used to specify the percentage amount of the payment due for the defined PaymentTimePeriod.		
	percentOfPaymentDue			Installment_ Payment Due. Percent Of Payment. Percent_ Numeric	specifies the exact amount of the payment due this payment period. The amount is expressed as a percent. The percent is sent with a decimal point only when needed, e.g., 10.5% is sent as 10.5.	1..1	

Class (ABIE)	Attribute (BBIE)	Association (ASBIE)	Secondary Class	Official Dictionary Entry Name	Definition	Multiplicity	Related Requirements
		None	PaymentTimePeriod	Installment_ Payment Due. Payment Time Period. Payment Due	This information on PaymentTimePeriod for InstallmentDue.	1..1	
NetPayment				Net_ Payment Due. Details	If used, a time period is required to specify when the payment is due.		
		None	PaymentTimePeriod	Net_ Payment Due. Association. Payment Due	The time period in which a payment is due may be specified in one of three ways:	1..1	
PaymentTerms				Payment Terms. Details	This class is the root class for the message.		
	paymentTermsEvent			Payment Terms. Event Type. Payment Terms Event_ Code	Provides the payment terms event from a code list.	1..1	
	paymentTermsType			Payment Terms. Payment Terms Type. Payment Terms_ Code	Required to define specific payment terms.	1..1	
	proximoCutoffDay			Payment Terms. Proximo Cut-off Day. DD_ Date Time	This class is used in conjunction with the payment term 'Proximo'. It contains a numeric value for the day of the month.value – The day of the month payment becomes due. value is mandatory.	0..1	
		None	DiscountPayment	Payment Terms. Association. Discount_ Payment Due	This information on DiscountPayment for PaymentTerms.	0..*	
		None	Installment Due	Payment Terms. Association. Installment_ Payment Due	This information on InstallmentDue for PaymentTerms.	0..1	
		None	NetPayment	Payment Terms. Association. Net_ Payment Due	This information on NetPayment for PaymentTerms.	0..1	
		None	PaymentMethod	Payment Terms. Association. Pay_ Payment Method	This information on PaymentMethod for PaymentTerms.	0..*	
PaymentTimePeriod				Payment Due. Details	Provides the payment time period information.		

Class (ABIE)	Attribute (BBIE)	Association (ASBIE)	Secondary Class	Official Dictionary Entry Name	Definition	Multiplicity	Related Requirements
	date			Payment Due. Choice_ Date. Numeric	The time at which an event occurs, expressed as a day	1..1	
	dayOfMonthDue			Payment Due. Choice_ Day Of Month. Numeric	The time at which a payment is due, expressed as a day of the month.	1..1	
		None	TimePeriod Due	Payment Due. Choice_ Association. Time Period	A time period, in which a number (the time period) is specified in terms of days, weeks, or months.	1..1	
TimePeriodDue				Time Period. Details	The payment time period in which the payment becomes due is expressed as a numeric value.		
	timePeriod			Time Period. Type. Code	The time span within which this event takes place	1..1	
	value			Time Period. Length. Duration_ Measure	Numeric value describing the time period in which the payment comes due. value is mandatory.	1..1	

3.14. Package Overview: Trade Item Common



3.15. Package Overview: Trade Item Common

3.15.1. Class Diagram: Out of Box Information

Process Common Components: Trade Item Common: Out of Box Information

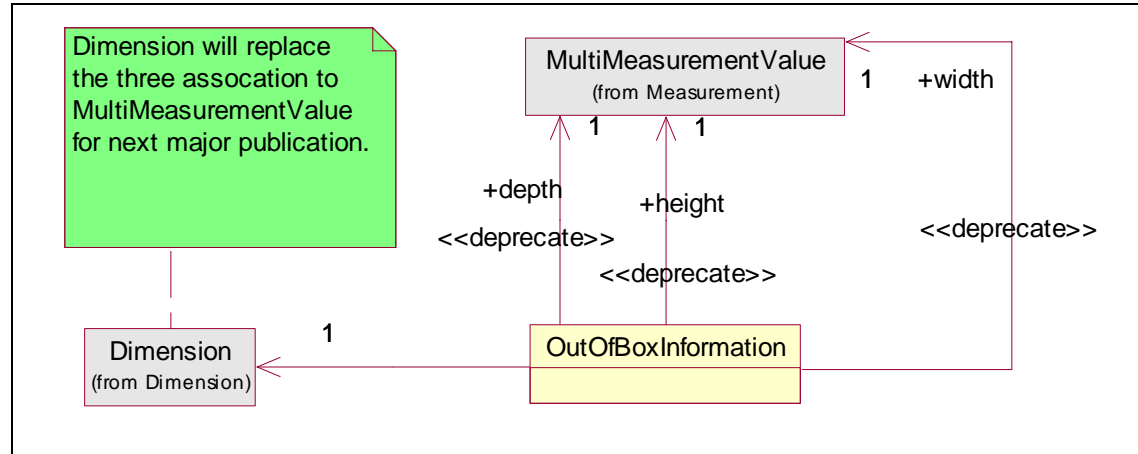

3.15.2. GDD Report: Out of Box Information

Class (ABIE)	Attribute (BBIE)	Association (ASBIE)	Secondary Class	Official Dictionary Entry Name	Definition	Multiplicity	Related Requirements
OutOfBoxInformation				Out Of Box_ Dimension. Details	The measurement of the actual Trade Item. These dimensions should be used for Items that do not require assembly but differ in size when removed from the packaging.		
		Depth	MultiMeasurementValue	Out Of Box_ Dimension. Depth_ Association. Multi-unit Measure	The measurement of the depth of the actual Trade Item. These dimensions should be used for Items that do not require assembly but differ in size when removed from the packaging.	1..1	

Class (ABIE)	Attribute (BBIE)	Association (ASBIE)	Secondary Class	Official Dictionary Entry Name	Definition	Multiplicity	Related Requirements
		Height	MultiMeasurementValue	Out Of Box_ Dimension. Height_ Association. Multi-unit Measure	The measurement of the height of the actual Trade Item. These dimensions should be used for Items that do not require assembly but differ in size when removed from the packaging.	1..1	
		Width	MultiMeasurementValue	Out Of Box_ Dimension. Width_ Association. Multi-unit Measure	The measurement of the width of the actual Trade Item. These dimensions should be used for Items that do not require assembly but differ in size when removed from the packaging.	1..1	

3.15.3. Class Diagram: Trade Item Entertainment

Process Common Components: Trade Item Common: Trade Item Entertainment

3.15.4. GDD Report: Trade Item Entertainment

Class (ABIE)	Attribute (BBIE)	Association (ASBIE)	Secondary Class	Official Dictionary Entry Name	Definition	Multiplicity	Related Requirements
EntertainmentProductDescription				Entertainment Product Description. Details	Provides various classifications common to entertainment related products (eg. movies, music) including format and genre.		
	mediaFormatCode			Entertainment Product Description. Media Format Code. Code Value_ Text	The code that identifies the type of media on which the piece of music is recorded and played.	1..*	
	productGenre			Entertainment Product Description. Product Genre. Text	The code of the genre of music trade item. The genre is a categorization of the music trade item based upon the content and maintained for marketing and merchandising purposes.	1..*	

Class (ABIE)	Attribute (BBIE)	Association (ASBIE)	Secondary Class	Official Dictionary Entry Name	Definition	Multiplicity	Related Requirements
	productLine			Entertainment Product Description. Product Line. Text	The name of the product line that the trade item belongs to. A product line is a price grouping.	0..*	
EntertainmentTradeItemPrice				Entertainment Trade Item Price. Details	The amount of money for which the trade item is bought or sold under various configurations.		
	bulkPrice			Entertainment Trade Item Price. Bulk_ Price. Amount	The amount of money for which the trade item is bought or sold when buying or selling a standard configuration.	0..1	
	loosePrice			Entertainment Trade Item Price. Loose_ Price. Amount	The amount of money for which the trade item is bought or sold when buying or selling individual units that are not in a standard configuration.	0..1	
OrderableReturnableInformation				Orderable Returnable Information. Details	Logical Grouping of Orderable Returnable Information		
	lastReturnableDateTime			Orderable Returnable Information. Last_ Returnable Date Time. DOTW_ Date Time	The last date AND time when a non sold trade item must be received by the manufacturer to receive credit.	0..1	
	orderableReturnableConditionsCode			Orderable Returnable Information. Orderable_ Returnable Conditions Code. Code	A code that indicates if the trade item can be ordered and returned if non-sold.	1..1	
PublicationTitleRating				Publication Title Rating. Details	Information regarding the content viewer maturity rating for an entertainment product.		

Class (ABIE)	Attribute (BBIE)	Association (ASBIE)	Secondary Class	Official Dictionary Entry Name	Definition	Multiplicity	Related Requirements
	ratingContentDescriptor			Publication Title Rating. rating_Content Descriptor. Text	A code that identifies one or several elements in a game that have triggered a particular rating and/or may be of interest or concern.	0..*	
	titleRating			Publication Title Rating. Title_Rating. Text	Code that identifies one or several elements in a game that have triggered a particular rating and/or may be of interest or concern.	1..1	
	titleRatingEntity			Publication Title Rating. Title_Rating Entity. Text	The name of an organization that defined the rating and attributed the rating content descriptor(s) to an electronic game.	1..1	

3.15.5. Class Diagram: Target Market Information

Process Common Components: Trade Item Common: Target Market Information

BRAD Implementation Feedback Phase #1 (BRAD P4CL: 7983)

Delete targetMarketDescription BR#1

Rationale:

The target market is identified with a code sent with "targetMarketCountryCode". The description is useless and requires useless cross checking to control that it matches the code.

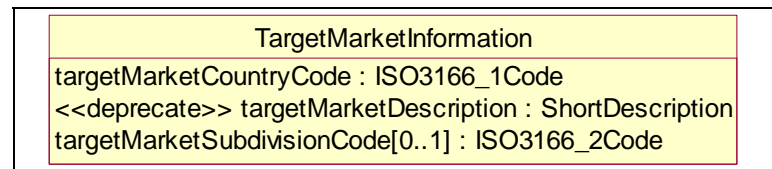

3.15.6. GDD Report: Target Market Information

Class (ABIE)	Attribute (BBIE)	Association (ASBIE)	Secondary Class	Official Dictionary Entry Name	Definition	Multiplicity	Related Requirements
TargetMarketInformation				Named_ Target Market. Details	!! This is a reusable class from Trade Item Common and referenced as part of the Trade Item Information class.		
	targetMarketCountry Code			Named_ Target Market. Country. ISO3166_1_ Code	The target market code indicates the country level or higher geographical definition in which the information provider will make the GTIN available to buyers. This Indicator does not in any way govern where the buyer may re-sell the GTIN to consumers.	1..1	
	targetMarketDescription			Named_ Target Market. Description. Code	The name for the specific target market identified with the Target Market Country Code. The description will be generated from the ISO 3166-1 code list.	1..1	
	targetMarketSubdivisionCode			Named_ Target Market. Subdivision. ISO3166_2_ Code	The Target Market Subdivision Code is the secondary code of the Target Market and must be a subdivision of a Target Market Country Code. The Target Market Subdivision Code describes the "geo-political subdivision of a country" where the trade item is available for sale; as determined by the information provider. For example; "State" in the US; "Land" in Germany; "Region" in France; or "Province" in Canada. Not all countries have subdivisions. This code is represented by the three-character ISO 3166-2 code. This Target Market Subdivision Code is a dependent attribute. It is important to note that the lack of the Target Market Subdivision code implies that the trade item is available in the entire target market country.	0..1	

3.15.7. Class Diagram: Trade Item Price Date Information

Process Common Components: Trade Item Common: Trade Item Price Date Information

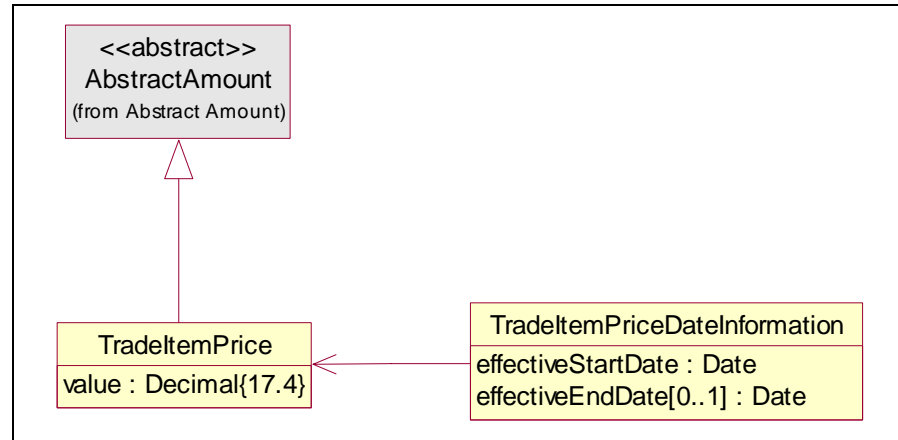

3.15.8. GDD Report: Trade Item Price Date Information

Class (ABIE)	Attribute (BBIE)	Association (ASBIE)	Secondary Class	Official Dictionary Entry Name	Definition	Multiplicity	Related Requirements
TradeltemPrice				Trade Item Price Information. Details	Provides the price for the trade item		
	value			Trade Item Price Information. Value. Numeric	Provides the trade item price.	1..1	
TradeltemPriceDateInformation				Trade Item Price. Details	Provides Price details including effective dates.		

Class (ABIE)	Attribute (BBIE)	Association (ASBIE)	Secondary Class	Official Dictionary Entry Name	Definition	Multiplicity	Related Requirements
	effectiveEnd Date			Trade Item Price. Effective_End Date. Date Time	!! The effective end date of the price is optional based upon the agreement by the trading partners. If an invalid end date is communicated; then it is implied that the price and its effective date are effective until further notice. Examples of invalid dates include 99/99/9999; 00/00/0000; blank; etc. These invalid end dates should not be communicated. Various types of dates may be pre-aligned between buyer and seller. For example; based upon a prior agreement between trading partners this date may relate to any of the following events; last order date; last ship date; and last arrival date.	0..1	
	effectiveStart Date			Trade Item Price. Effective_Start Date. Date Time	!! This is the effective start date of the price agreed to by the trading partners. This start date is mandatory and; if no end date is communicated; then implies that the price is effective until further notice. Various types of dates may be pre-aligned between buyer and seller. For example; based upon a prior agreement between trading partners this date may relate to any of the following events; first order date; first ship date; and first arrival date.	1..1	
			TradeItemPrice	Trade Item Price. Association. Trade Item Price Information	Provides the trade item price value.	1..1	

3.15.9. Class Diagram: Warranty Information

Process Common Components: Trade Item Common: Warranty Information

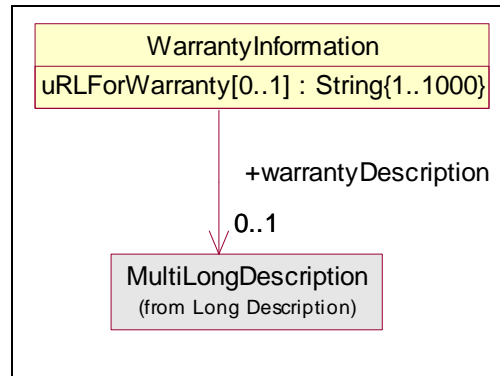

3.15.10. GDD Report: Warranty Information

Class (ABIE)	Attribute (BBIE)	Association (ASBIE)	Secondary Class	Official Dictionary Entry Name	Definition	Multiplicity	Related Requirements
WarrantyInformation				Warranty. Details	Provides information on the usually written guarantee of the integrity of a product and of the maker's responsibility for the repair or replacement of defective parts.		
	uRlForWarranty			Warranty. URL For Warranty. Text	Indicates the location of the URL that contains the warranty information of the Item.	0..1	
		warrantyDescription	MultiLongDescription	Warranty. Warranty Description. Long_ Multi-language Description	Description of the warranty information as found on the Item.	0..1	

4. Summary of Changes

Change	BMS Doc Version	Associated CR Number

Change	BMS Doc Version	Associated CR Number
<p>Section 3.5.3 Trade Item Identification</p> <p>Renamed Class FROM:CommonAdditionalTradeItemIdentification TO : AdditionalTradeItemIdentification</p> <p>Deleted role name +additionalTradeItemIdentification as the revised class name defaults to the same name.</p>	0.1.2	For consistency to Party Identification structure.
<p>Section 3.4.1 Extended Data Type</p> <p>Renamed Attributes in Class Character Attribute FROM: character Attribute TO : characterString Class TimeZone Attribute FROM: timeZone Attribute TO : timeZoneDesignator Class Version Attribute FROM: version Attribute TO : versionIdentification</p>	0.1.2	<p>To differentiate the class name and attribute name.</p> <p>Helps to avoid the duplicate data element names in our standards.</p>
<p>Removed Section 4.1 and 4.1.1 Application Receipt Acknowledgment</p>	0.1.2	<p>Removed as ARA is a message and is contained in it's own BRD P4CL: 4844 BRD Ver: 0.41.2</p>
<p>Finished Plan Common section 4.7 to 4.7.6</p>	0.1.2	Finished the remaining balance of 2.0 publication common library
<p>Section 3.2.1. Amount Renamed Attribute in Class Character and corrected dataType Typo Attribute FROM: currencyISOCode : ISO4217Code Attribute TO: currencyCode : ISO4217_Code</p>	0.1.3	Avoid duplicate element name in message.

Change	BMS Doc Version	Associated CR Number
Corrected dataType Typo in following classes and section Class: Description (3.2.3.) Class: LongDescription (3.2.4) Attribute FROM: language : ISO639Code Attribute TO : language : ISO639_Code:	0.1.3	
Renamed class BinarySignature (4.2.3.) FROM: BinarySignature TO : BinarySignatureInformation	0.1.3	Avoid duplicate element name in message.
Change in role name to match BRD. Order Logistical Information (4.4.1) OrderLogisticalDateGroup associated to LogisticalDate Role FROM: requestedDeliveryDateUltimateConsignee Role TO : requestedDeliveryDateAtUltimateConsignee	0.1.3	Consistency and matches the BRD requirements.
Section 4.9.2 Name And Address Renamed Attribute in Class NameAndAddress Attribute FROM: currencyISOCODE : ISO4217_Code Attribute TO : currencyCode : ISO4217_Code	0.1.3	Avoid duplicate element name in message.
Section 4.11.1 Allowance Charge Change in role name AllowanceCharge associated to MultiDescription Role FROM: description Role TO : allowanceChargeDescription	0.1.3	Avoid duplicate element name in message.
Section 3.5.2 Party Identification Change attribute name in AdditionalPartyIdentification Attribute FROM: additionalPartyIdentification Attribute TO : additionalPartyIdentificationValue	0.1.4	Avoid duplicate element name
Added code list to common library in section 1.5.4.	0.1.4	Added code list

Change	BMS Doc Version	Associated CR Number
Updated Deliver Reference Code List added following additional code values ACCOUNTS_RECEIVABLE_CUSTOMER_ACCOUNT AGENTS_SHIPMENT_NUMBER APPROPRIATION_NUMBER DEALER_ORDER_NUMBER EMPLOYERS_IDENTIFICATION_NUMBER FEDERAL_TAXPAYERS_IDENTIFICATION_NUMBER FOOD_AND_DRUG_ADMINISTRATION_FDA_PRODUCT_CODE INVALID_ACCOUNT_REASON_CODE LOCATION_NUMBER MANIFEST_KEY_NUMBER NEXT_AVAILABLE_FLIGHT_JOB_NUMBER PACKAGE_NUMBER PART_NUMBER PORT_CODE PRODUCTION_CODE PURCHASE_ORDER_ITEM_NUMBER PURCHASE_REQUISITION_NUMBER SALESPERSON SERIAL_NUMBER SERVICE_REQUEST_NUMBER SOCIAL_SECURITY_NUMBER SOFTWARE_APPLICATION_NUMBER VENDOR_IDENTIFICATION_NUMBER	0.1.5	Updated Code List
Replaced existing Exception Status Type Code List with the following values EXCEPTION_REASON_ONLY EXCEPTION_REASON_WITH_RESOLUTION EXCEPTION_REASON_WITH_STATUS	0.1.5	Updated Code List
Document Class: 3.1.2. For Datatype replaced Version=2.0 to	0.1.6.	Update
Based on Order Response work Added to Common Library section 3.1.4 ResponsesDocument This is similar to the Document structure, but this should be used for document responses.	0.1.7	New Additions

Change	BMS Doc Version	Associated CR Number
Based on work from MultiShipTo and Order Created new class: TradeAgreement section 4.4.4	0.1.7	New Additions
Based on work from MultiShipTo and Order Created new class: Transportation Mode Section 4.9.4	0.1.7	New Addition
Based on work from MultiShipTo and Order Modified OrderLogisticalInformation section 4.4.1 Created association From: ShipToLogistics TO: TransportationMode class 0..1 Created choice association From: ShipToLogistics TO: NameAndAddress class role +shipToNonCommercial1..1 Created choice association From: ShipToLogistics TO: PartyIdentification class role +shipTo1..1	0.1.7	Modification
Based on work from MultiShipTo and Order Modified OrderPartyInformation section 4.4.2 Created association From: OrderPartyInformation TO: Contact class role +orderContact0..1	0.1.7	Modification
Based on work from MultiShipTo and Order Modified SimpleOrderLineItem section 4.4.3 Created association From: SimpleOrderLineItem TO: TransportationMode class 0..1	0.1.7	Modification
Based on public review from Order BRG. Added an optional unitOfMeasure attribute to the SimpleOrderLineItem class. Section 4.4.3 Order rejected the idea to reuse the MeasurementValue class because there requirement was to have an optional UoM.	0.1.8	Modification

Change	BMS Doc Version	Associated CR Number
<p>Based on Publicatoin 2.0.1 work on Plan. Added missing Code Lists into section 1.5. Following four code lists were added.</p> <p>ConsumerIncentiveTacticTypeCodeList DisplayTacticTypeCodeList FeatureTacticTypeCodeList TradeItemPackingLabelingTacticTypeCodeList</p> <p>EventTacticTypeCode (aggregate of enumerated code lists) Class diagram was inserted in section 4.7.3</p>	0.1.9	<p>Additions to section 1.5</p> <p>Section 4.7.3 Event Tactic Type Code class diagram</p>
<p>Added creationDateTime:DateTime into ResponseDocument Class.</p>	0.1.13	<p>Derived from BSD P4CL: 6359 BSD Title: Order Response BSD Version: 0.1.5</p> <p>Changed enforced based on the public review Order Response BSD</p>

Change	BMS Doc Version	Associated CR Number
<p>New components (new sections):</p> <p><u>Document Reference</u></p> <p><u>Quantity</u></p> <p><u>Logistic Unit Identification</u></p> <p><u>Unit Measurement</u></p> <p><u>Logistic Unit Measurement</u></p> <p><u>Inventory Status Line Item</u></p> <p><u>QuantitySpecification</u></p> <p>Modifications to existing sections:</p> <p><u>Date And Time</u></p> <p>Added class TimeOrDateTimePeriod</p> <p><u>Trade Item Unit Or Logistic Unit</u></p> <p>Split into two sections: 1. Logistic Units and 2. Item Containment</p> <p><u>LogisticUnits</u></p> <p>To class LogisticUnits added following attributes:</p> <p>quantityOfChildren,</p> <p>packageType,</p> <p>childPackageType,</p> <p>and added the following associations:</p> <p>LevelIdentification (+levelId),</p> <p>LevelIdentification (+parentLevelId),</p> <p>LogisticUnitIdentification,</p> <p>LogisticUnitMeasurement</p> <p>and removed attribute</p> <p>Identification</p> <p>and removed association</p> <p>ItemContainment (+itemsContained)</p> <p>Added class LevelIdentification</p> <p><u>ItemContainment</u></p> <p>Class ItemContainment</p> <p>Added inheritance to Lineltem</p> <p>Removed attribute quantityContained</p> <p>Added association to TradeItemIdentification (+requestedItemIdentification)</p> <p>Added associations to DetailLevelReference (+customer, +productCertification, +promotionalDeal, +specification) and moved one association (+purchaseOrder)</p> <p>Added associations to DocumentOrDocumentLineReference (+purchaseOrder, +purchaseConditions)</p> <p>TradeItemUnit: class was removed</p> <p>Removed class AdditionalItemData</p> <p><u>Transactional Item Data</u></p> <p>To class TransactionalItemData</p>	0.2.0	
<p>Added attributes batchNumber, bestBeforeDate, packagingDate, shelfLife</p> <p>Removed attribute quantityContained</p> <p>Added association to UnitMeasurement (+transactionalItemWeight)</p>		

Change	BMS Doc Version	Associated CR Number
Added Goods Requirements Line Item.	0.2.1	
Added Extension Point to ItemContainment: Updated GDD Report Updated Item Containment Model ItemContainment class added attribute extension[0..1] : Extension	0.2.2	
Updated Extended Data Types PackageTypeDescriptionCode MeasurementUnitCode	0.2.3	
Added Transportation Payment Method Code List which will replace Deliver Payment Method Code List in next major publication.	0.2.4	
Added QuantityRange to Range package	0.2.6	
GoodsRequirementsLineItem Association to DocumentReference (+purchaseConditions) was changed into DocumentOrDocumentLineReference (+purchaseConditions).	0.2.7	
TransactionalItemData: added attributes countryOfOrigin[0..1] : ISO3166_1Code productQualityIndication[0..1] : Quantity	0.2.8	
Created new class CurrencyExchangeRateInformation currencyConversionFrom : ISO4217_Code currencyConversionTo : ISO4217_Code exchangeRate : Float	0.2.9	
Additional Trade Item Identification List Added 20 qualifiers FOR_INTERNAL_USE_1..20 Additional Party Identification List Added 20 qualifiers FOR_INTERNAL_USE_1..20	0.2.10	
PaymentTerms / Discount Payment added attributes discountAmount[0..1]: Amount discountPercent[0..1]: Percentage	0.2.11	

Change	BMS Doc Version	Associated CR Number
<p>Added Transportation Reference which will replace Deliver Reference</p> <p>Added Transportation Reference Code List which will replace Deliver Reference Code List</p> <p>Added Hazardous Shipment Information which will replace Bill of Lading Hazardous Information</p> <p>Added Invoice following classes into Process Common: Pay Common 1. Tax Information 2. Invoice Party</p> <p>Added Trade Item Price Date Information into Process Common: Trade Item Common</p> <p>Added Dimension into Common Library for Major Pubs 3.0 Release.</p> <p>Added Entertainment Common into Process Common: Trade Item Common</p> <p>Added Out of Box Information into Process Common: Trade Item Common</p> <p>Added Description 2500 Description2500 added attributes language : ISO639_Code text : String{1..2500} MultiDescription2500 added attribute description[1..*] : Description2500</p> <p>Added Description 5000 Description5000 added attributes language : ISO639_Code text : String{1..5000} MultiDescription5000 added attribute description[1..*] : Description5000</p> <p>Need to review Measurement Unit Code List (External) and Package Type Description Code List (External) for next major publication.</p>	0.2.12	

Change	BMS Doc Version	Associated CR Number
Added Receiving Condition Code List into Common Library. Originated from Deliver context, Reused in Pay Advanced Remittance Notice. Added SUBSTITUTED_ITEM in code list.	0.2.13	
Added FMCG Trade Item Identification	0.2.14	
GS1 Code List policy states special characters are not allowed for code names. The change originated from Claims Notification BSD work. Noted are the detail changes to the MessageReasonList. 74_CANCEL_OR_ADJUST_PRIOR_CREDIT_OR_DEBIT_ADJUSTME→ 74_CANCEL_OR_ADJUST_PRIOR_CREDIT_OR_DEBIT_ADJUSTMENT Removed (ERS) 83_EVALUATED_RECEIPT_SETTLEMENT_(ERS)_DELIVERY_CHARGE→ 83_EVALUATED_RECEIPT_SETTLEMENT_DELIVERY_CHARGE Removed parenthesis BM_NET_COLLECTION_EXPENSE_(FACTOR)→ BM_NET_COLLECTION_EXPENSE_FACTOR Removed parenthesis BP_NET_CHARGEBACK_OF_CLIENT_RISK_(FACTOR)→ BP_NET_CHARGEBACK_OF_CLIENT_RISK_FACTOR Replaced % with Percentage E6_GOODS_AND_SERVICES_TAX_0%_RATE_INTERNATIONAL_DOCUMENTATION_WILL_FOLLOW→ E6_GOODS_AND_SERVICES_TAX_0_PERCENTAGE_RATE_INTERNATIONAL_DOCUMENTATION_WILL_FOLLOW RR_HANDLING_CHARGE_FOR_UNREADABLE_ADVANCE_SHIP_NOT→ RR_HANDLING_CHARGE_FOR_UNREADABLE_ADVANCE_SHIP_NOTICE ST_UNAUTHORIZED_AIR_SHIPMENT_CHARGEBACK_IS_THE_DIFFERENCE_BETWEENAIR_AND_GROUND →ST_UNAUTHORIZED_AIR_SHIPMENT_CHARGEBACK_IS_THE_DIFFERENCE_BETWEEN_AIR_AND_GROUND	0.2.15	GS1 code policy not to use special characteristics for code names.
GS1 Code List policy states special characters are not allowed for code names. Noted are the detail changes to the Service Level Code List. Remove colon. PRIMARY_SERVICE_AREA_NEXT_DAY_BY_5:00_PM→ PRIMARY_SERVICE_AREA_NEXT_DAY_BY_1700 PRIMARY_SERVICE_AREA_NEXT_DAY_BY_10:30_AM→ PRIMARY_SERVICE_AREA_NEXT_DAY_BY_1030	0.2.16	
CurrencyExchangeRateInformation Added new optional attribute exchangeRateDate.	0.2.17	n/a
Delete targetMarketDescription Rationale The target market is identified with a code sent with "targetMarketCountryCode". The description is useless and requires useless cross checking to control that it matches the code.	0.2.18	05-000389 Source from BRAD Implementation Feedback Phase #1 P4CL: 7983

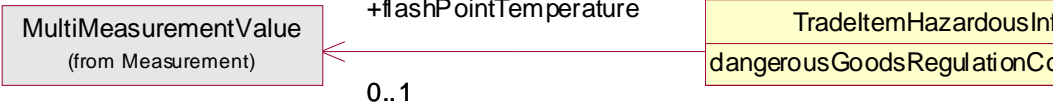
Change	BMS Doc Version	Associated CR Number
<p>Changed cardinality from mandatory to optional for flashPointTemperature. Trade Item Hazardous Information associated to Multi Measurement Value</p>  <pre> classDiagram class MultiMeasurementValue { (from Measurement) } class TradeItemHazardousInformation { dangerousGoodsRegulationCode } MultiMeasurementValue "0..1" -- TradeItemHazardousInformation : +flashPointTemperature </pre>	0.2.20	04-44 BRAD Implementation Feedback Appendix D/E p4CL: 8023 BR 12
Added UN_INFODS_Code to Extended Data Types Class Diagram.	0.2.21	CR 05-000195
Added Payment Discount to Pay Common as it is reused in Advanced Remittance Notification and EU National Extension Pasted in Class Diagram, Need to populate GDD.	0.2.22	
Common Library updated for next major release. Updated Document to reflect Modelling Team recommendation. Remove the redundant Data Description Report and consolidated into a column within GDD report Removed the Code Lists and future work will reference GDD for most current lists. Consoildated Class Diagram and GDD report snapshot. Modelling team performed QA measures against Model and GDD Report. The Common Library Project schedule can be referenced P4CL: 8563	0.2.23	

Change	BMS Doc Version	Associated CR Number
<p>Common Library Updated for BMS Release Version 2.3 Section 3.8.9 Invoice Tax Information Based on BSD Invoice BMS Release Version 2.3 InvoiceTaxInformation Addition of taxPercentage[0..1]:Percentage{3..2}</p> <div data-bbox="323 456 898 704" style="border: 1px solid black; padding: 5px; margin: 10px 0;"> <p style="text-align: center;">InvoiceTaxInformation</p> <p>dutyTaxFeeType[0..1] : DutyTaxFeeTypeCodeList extension[0..1] : Extension taxableAmount[0..1] : Float taxableAmountInTaxAccountingCurrency[0..1] : Float taxAmount[0..1] : Float taxAmountInTaxAccountingCurrency[0..1] : Float taxPercentage[0..1] : Percentage{3.2}</p> </div> <p>SimpleOrderLineItem Added attribute additionalOrderLineInstruction[0..1]:Description lineItemActionCode[0..1]:OrderLineItemActionCodeList</p> <div data-bbox="323 919 1304 1442" style="border: 1px solid black; padding: 10px; margin: 10px 0;"> <pre> classDiagram class LinelItem { <<abstract>> } class SimpleOrderLineItem { requestedQuantity : Quantity additionalOrderLineInstruction[0..1] : Description lineItemActionCode[0..1] : OrderLineItemActionCodeList } class TradeItemIdentification { (from Trade Item Identification) } class MultiAmount { (from Amount) } class ShipmentTransportationInformation { (from Shipment Transportation Information) } LinelItem < -- SimpleOrderLineItem SimpleOrderLineItem "1" --> TradeItemIdentification SimpleOrderLineItem "0..1" --> MultiAmount : +netPrice SimpleOrderLineItem "0..1" --> MultiAmount : +netAmount SimpleOrderLineItem "0..1" --> ShipmentTransportationInformation </pre> <p>UN/ECE Recommendation 20 is referenced as possible values for unit of measure.</p> <p>additionalOrderLineInstruction should only be used in exception circumstances if the information cannot be codified.</p> </div>	0.4.0	07-000128 06-000300 06-000301 06-000302 06-000282 06-000283 06-000285 06-000297 CR 07-00026/27/31

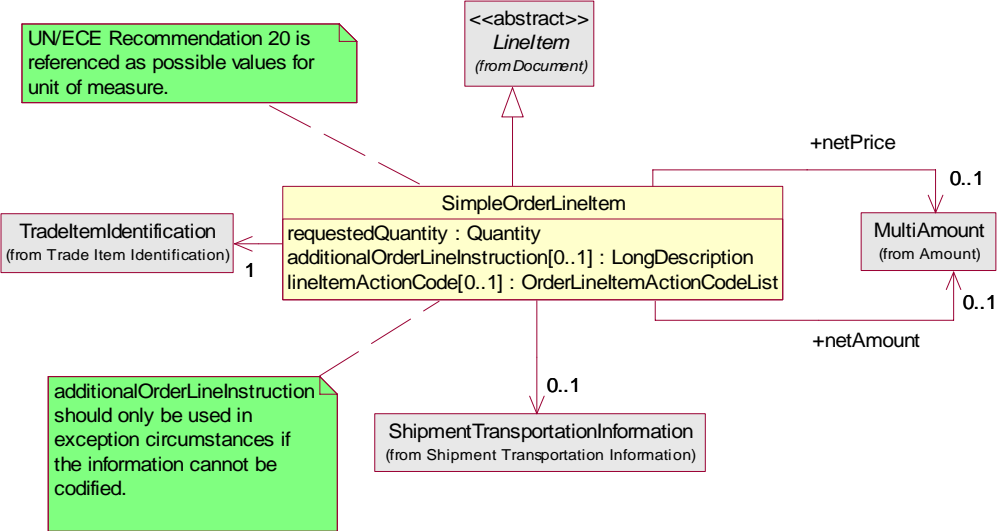
Change	BMS Doc Version	Associated CR Number
<p>Simple Order Line Item Changed in SimpleOrderLineItem datatype from Description-->LongDescription additionalOrderLineInstruction[0..1] : Description-> additionalOrderLineInstruction[0..1] : LongDescription</p> 	0.4.1	Based on Public Review 200704
<p>GDD Report Trade Item Hazardous Information Aligned the multiplicity of flashPointTemperature to optional 0..1</p> <p>Model and GDD Report Event Tactic Type Code Fixed typo on featureTacticTypeCode : FeatureTacticTypeCodeList</p>	0.4.3	

Change	BMS Doc Version	Associated CR Number
BMS upgraded for Release 2.4.0 Added Order Header Indicator Structure Common Library Addition <ul style="list-style-type: none"> ■ OrderHeaderIndicator added attributes ■ isApplicationReceiptAcknowledgementRequired ■ isOrderFreeOfExciseTaxDuty Added String Facets to align with the Description field lengths. Despatch Advice Work BMS Release 2.4 Added Despatch Information into Deliver Common	0.5.0	<ul style="list-style-type: none"> ■ CR 07-000077 ■ CR 07-000098 ■ CR 07-000103
Moved following structure into Common Library From Pay VAT TAX Information Extension VAT Invoice Party Extension Structure was not changed only included into Common Library for BMS Release 2.4.0	0.5.1	
Package Dimension Removed the association from PackageDimension to Dimension As the reuse was redundant.	0.5.2	