



EANCOM[®] 2002, Edition 2016 Upd. 2021 Syntax 3, Part 1

Issue 1.3, May 2022



Document Summary

Document Item	Current Value
Document Title	GS1 EANCOM 2002, Edition 2016 Upd. 2021, Syntax 3
Date Last Modified	May 2022
Document Version	1
Document Issue	3
Document Status	Ratified
Document Description	Description for GS1 EANCOM® 2002 Syntax version 3

Contributors

Name	Organization
GS1 eCom Standard Maintenance Group members	GS1

Log of Changes

Issue No.	Date of Change	Changed By	Summary of Change
1	July 2016	Ewa Iwicka	Revised introduction and various sections of Part 1
2	July 2017	Ewa Iwicka	<ul style="list-style-type: none"> ■ Changed terminology, following the standard name change from eCom to EDI ■ Section 2.3.3: Added explanation when to use PRODAT and PRICAT messages ■ Section 1.3.2: Added reference to the new Use of GS1 keys in GS1 EDI messages Guideline document
3	May 2022	Global Office	Section 4.15.4: Application Identifiers updated

Disclaimer

WHILST EVERY EFFORT HAS BEEN MADE TO ENSURE THAT THE GUIDELINES TO USE THE GS1 STANDARDS CONTAINED IN THE DOCUMENT ARE CORRECT, GS1 AND ANY OTHER PARTY INVOLVED IN THE CREATION OF THE DOCUMENT HEREBY STATE THAT THE DOCUMENT IS PROVIDED WITHOUT WARRANTY, EITHER EXPRESSED OR IMPLIED, REGARDING ANY MATTER, INCLUDING BUT NOT LIMITED TO THE OF ACCURACY, MERCHANTABILITY OR FITNESS FOR A PARTICULAR PURPOSE, AND HEREBY DISCLAIM ANY AND ALL LIABILITY, DIRECT OR INDIRECT, FOR ANY DAMAGES OR LOSS RELATING TO OR RESULTING FROM THE USE OF THE DOCUMENT. THE DOCUMENT MAY BE MODIFIED, SUBJECT TO DEVELOPMENTS IN TECHNOLOGY, CHANGES TO THE STANDARDS, OR NEW LEGAL REQUIREMENTS. SEVERAL PRODUCTS AND COMPANY NAMES MENTIONED HEREIN MAY BE TRADEMARKS AND/OR REGISTERED TRADEMARKS OF THEIR RESPECTIVE COMPANIES. GS1 IS A REGISTERED TRADEMARK OF GS1 AISBL.

Table of Contents

1. Overview	6
1.1. Introduction.....	6
1.2. GS1 System	6
1.3. GS1 Standards.....	6
1.3.1. GS1 eCom (EDI) Standards.....	7
1.3.2. GS1 Identification Keys	7
1.3.3. Data Carriers	8
1.3.4. GS1 Global Data Synchronisation Network	8
2. EANCOM® MESSAGES.....	9
2.1. Categorisation	9
2.2. EANCOM® Information Flow	9
2.3. Master Data Alignment.....	10
2.3.1. Party Information (PARTIN)	10
2.3.2. Product Inquiry (PROINQ).....	11
2.3.3. Product Data (PRODAT)	11
2.3.4. Price/Sales Catalogue (PRICAT)	11
2.4. Transactions.....	12
2.4.1. Pre-Order Messages	12
2.4.2. Order Messages	13
2.4.3. Transport and Delivery Messages.....	14
2.4.4. Payment and Financial Messages	17
2.5. Report and Planning	19
2.5.1. Delivery Schedule (DELFOR)	19
2.5.2. Sales Data Report (SLSRPT).....	19
2.5.3. Sales Forecast Report (SLSFCT)	19
2.5.4. Inventory Report (INVRPT)	19
2.5.5. Syntax and Service Report Message (CONTRL).....	20
2.5.6. Application Error and Acknowledgement (APERAK)	20
2.5.7. Multiple Debit Advice (DEBMUL)	20
2.5.8. Multiple Credit Advice (CREMUL)	20
2.5.9. Banking Status (BANSTA)	20
2.5.10. Financial Cancellation (FINCAN)	21
2.5.11. Financial Statement (FINSTA)	21
2.5.12. Direct Debit (DIRDEB).....	21
2.5.13. Metered Services Consumption Report (MSCONS)	21
2.5.14. Quality Test Report (QUALITY)	21
2.6. Miscellaneous	21
2.6.1. Drawing Administration (CONDRA)	21
2.6.2. General Message (GENRAL).....	22

3.	MAINTENANCE AND IMPLEMENTATION OF EANCOM®	22
3.1.	Maintenance Aspects	22
3.1.1.	Policy	22
3.1.2.	Processing a Work Request (WR)	22
3.1.3.	Code List Publication	23
3.2.	Implementation Aspects	24
3.2.1.	Publications	24
3.2.2.	EANCOM® Manual	24
3.2.3.	EANCOM® and Data Alignment	24
3.2.4.	EANCOM® Translation Tables	24
3.2.5.	Support of Message Versions	24
4.	SPECIFIC RULES	25
4.1.	Identification of trade items	25
4.1.1.	Variable quantity trade items	25
4.1.2.	Mixed Assortments	25
4.1.3.	Promotional variants (PIA)	26
4.2.	Identification of logistic units (PCI/GIN)	26
4.3.	Identification of parties and locations (NAD)	27
4.4.	Date, time and period (DTM)	27
4.5.	Free text (FTX)	28
4.6.	Item descriptions (IMD)	28
4.6.1.	Formats	28
4.6.2.	Segment structure	28
4.6.3.	Segment population	29
4.6.4.	Segment repetition and sequencing	29
4.6.5.	Data alignment	29
4.7.	Currencies (CUX)	30
4.8.	Standard allowances and charges (ALC)	30
4.9.	Temporary codes, use of DE 3055 and 1131	31
4.10.	Sub-lines in EANCOM® messages	31
4.10.1.	Examples of the use of sub-lines	33
4.10.2.	Sub-line amendment	36
4.10.3.	Sub-line deletion	36
4.11.	Hierarchies in PRICAT/PRODAT	37
4.12.	Referencing in EANCOM® (RFF)	38
4.13.	Package Marking in EANCOM®	39
4.14.	Communicating GS1 trade item numbers in EANCOM®	40
4.15.	GS1 Application Identifiers in EANCOM®	40
4.15.1.	Application Identifiers related to trade items	41
4.15.2.	Application Identifiers related to logistic units	42
4.15.3.	Application Identifiers related to locations	43
4.15.4.	Application Identifiers related to assets	43
4.15.5.	Other Applications	44

5.	APPENDIX 1: UN/EDIFACT.....	44
5.1.	Definition of UN/EDIFACT.....	44
5.2.	EDIFACT Syntax version 4 overview.....	44
5.2.1.	Interchange Structure.....	44
5.2.2.	Message Structure.....	45
5.2.3.	Segment structure.....	46
5.2.4.	Service characters.....	46
5.2.5.	Compression of data.....	47
5.2.6.	Representation of numeric values.....	48
5.2.7.	Character set and syntax identifiers.....	49
5.3.	Directory status, version and release.....	51
5.4.	EANCOM® message version.....	51
5.5.	Documentation conventions.....	51
5.5.1.	Format and picture of data elements.....	51
5.5.2.	Indicators.....	52
5.6.	Message structure charts and branching diagrams.....	53
5.7.	Interchange structure and service segments.....	55
6.	APPENDIX 2: GLOSSARY OF EDI TERMINOLOGY.....	64

2. Overview

2.1. Introduction

The GS1 EANCOM® standard is a subset of selected UN/EDIFACT messages, based on UN/EDIFACT directory D.01B, syntax version 3 which was released by UN/CEFACT in 2001. It includes only components that are mandatory and those relevant for the GS1 user community.

This document is the manual for the EANCOM® 2002 syntax version 3. It is an implementation guideline containing detailed descriptions of the use of the messages and their components to support their electronic exchange between trading partner applications, as well as usage examples and sample data.

This manual is developed by GS1 and represents an integral part of the suite of GS1 supply chain solutions. In this context, the EANCOM® manual should be read in conjunction with the "GS1 General Specifications" manual which describes the GS1 Identification and Bar Code standards.

It is important to note that the EANCOM® 2002 syntax versions 3 and 4, replaces the EANCOM® 1997 syntax version 3, release which was based on UN/EDIFACT directory D.96A. Therefore, at the time of publication of this manual, the EANCOM® 2002 syntax versions 3 and 4, becomes the EANCOM® standard.

In terms of future maintenance and processing of new user requirements, work requests will be processed only against EANCOM® 2002 syntax versions 3 and 4.

It should be noted that Syntax 4 provides security features, such as Digital Signature and Digital Certificates that are not available in Syntax 3. Users that need to implement these security components together with the EANCOM® messages should refer to the part of this Manual related to Syntax 4.

2.2. GS1 System

The GS1 System is an integrated system of global standards that provides for accurate identification and communication of information regarding products, assets, services and locations. It is the most implemented supply chain standards system in the world. It is the foundation of a wide range of efficiency-building supply chain applications and solutions.

The GS1 system is developed and managed by [GS1](#), using the GS1 Global Standards Management Process ([GSMP](#)).

2.3. GS1 Standards

The international GS1 Standards include:

- Standard **identification** of trade items (products or services), logistic units, assets, locations, service relationships, and other special applications, as well as supplementary codes to encode variable data.
- Standard **data carriers** to allow the automatic and secure capture of the standard identification.
- Global standards for **electronic business messaging – eCom** that allow rapid, efficient and accurate automatic electronic transmission of agreed business data between trading partners.
- The **Global Data Synchronisation Network™** (GDSN™) is an automated, standards-based, global environment that enables secure and continuous data synchronisation, allowing all partners to have consistent item data in their systems at the same time.

- **GS1 EPC Global®** is a set of standards that combines RFID (radio frequency identification) technology, existing communications network infrastructure and the Electronic Product Code (a number for uniquely identifying an item) to enable immediate and automatic identification and tracking of an item through the whole supply chain globally, resulting in improved efficiency and visibility of the supply chain.

1.3.1. GS1 eCom (EDI) Standards

GS1 eCom stands for electronic communication using standard business messaging. GS1 eCom is the GS1 term for **Electronic Data Interchange** (EDI): the interchange of structured data according to agreed message standards, by electronic means.

- GS1 EANCOM®
- GS1 XML

Both sets of eCom standards are implemented in parallel by different users. Although XML is a newer technology than the EANCOM®, the latter has a large and constantly growing number of users.

GS1 is going to continue supporting both syntaxes for as long as it is necessary. Any new developments, however (e.g. messages for sectors new to GS1) by default will be done only in GS1 XML. New EANCOM® developments in new domains will be done only if there is a justified business reason.

The existing EANCOM® messages will be supported and developed based on the user needs.

1.3.2. GS1 Identification Keys

Currently, there are nine GS1 Identification Keys that support the identification of trade items, services, locations, logistic units, assets, shipments, consignments, etc. The GS1 [Company Prefix](#) assigned to a user company allows that user company to create any of the GS1 identification keys.

- **[Global Location Number](#) GLN** identifies locations: physical locations and legal entities where is a need to retrieve pre-defined information to improve the efficiency of communication with the supply-chain
- **[Global Trade Item Number](#) GTIN** identifies trade items: products or services that may be priced, or ordered, or invoiced at any point in any supply chain
- **[Serial Shipping Container Code](#) SSCC** identifies logistic units: items of any composition established for transport and/or storage which needs to be managed through the supply chain
- **[Global Identification Number for Consignment](#) GINC** identifies consignments: logical groupings of goods (one or more physical entities) that are intended to be transported as a whole from a Shipper (Consignor) to a Receiver (Consignee) by a carrier or freight forwarder
- **[Global Individual Asset Identifier](#) GIAI** identifies individual assets like a computer, a desk or a component part of an aircraft, e.g. to record their life cycle.
- **[Global Returnable Asset Identifier](#) GRAI** identifies reusable package or transport equipment that are considered an asset. It is used to enable tracking as well as recording of all relevant data associated with the asset or asset reference.
- **[Global Shipment Identification Number](#) GSIN** identifies shipment: a grouping of logistics units that comprise a shipment from one seller of goods to one buyer referencing a Dispatch Advice and/or Bill Of Lading
- **[Global Service Relation Number](#) GSRN** identifies the recipient of services in the context of a service relationship. It is used to enable access to a database entry for recording recurring services.

- **Global Document Type Identifier GDTI** identifies a document type combined with an optional serial number and used to access database information that is required for document control purposes.

1.3.3. Data Carriers

GS1 has an entire portfolio of Data Carriers – media that can encode GS1 ID Keys and attribute data in a machine readable format:

- **EAN/UPC** family of bar codes that are the most widely used GS1 data carriers. They are used to scan trade items at the Point-of-Sale and in logistic applications
- **ITF-14** (Interleaved 2-of-5) bar codes carry ID numbers only on trade items that are not expected to pass through the Point-of-Sale
- The **GS1-128** bar code is a subset of the Code 128 Bar Code Symbology. Its use is exclusively licensed to GS1. This extremely flexible symbology can carry all GS1 Keys and attributes but cannot be used to identify items crossing Point-of-Sale.
- **GS1 DataBar** family of bar codes that can be scanned at retail point-of-sale (POS), are smaller than EAN/UPC and can carry additional information such as serial numbers, lot numbers of expiry dates. Composite Bar Code integrates both a GS1 System linear symbol and a 2D Composite Component as a single symbology and is approved for special healthcare applications.
- **GS1 DataMatrix** is a "2D Matrix" symbol used for example in healthcare sector. Because GS1 DataMatrix requires camera based scanners it is currently specified for healthcare items not crossing POS and direct part marking. GS1 QR Code is a "2D Matrix" symbol and is approved for Extended Packaging applications using mobile devices for scanning.
- **EPC/RFID tags** use Radio-Frequency Identification technology to encode GS1 ID Keys in the GS1 Electronic Product Code (EPC). RFID works via a microchip, which stores the relevant data (including the EPC) and reflects the data to a reader antenna by means of electromagnetic waves. Since these waves can pass through solid materials, the chips may be shielded by adhesive film or integrated directly inside the packaging or product.

More information about the GS1 Data Carriers and GS1 Identification Keys can be found in the GS1 General Specifications - the core document describing how these standards should be used to comply with GS1 System.

1.3.4. GS1 Global Data Synchronisation Network

The Global Data Synchronisation allows exchanging Master Data in an automated manner.

Master Data are fixed attributes of products and parties that never (or hardly ever) change. They need to be aligned between trading partners before any transactional messages, like, Order, Despatch Advice or Invoice are exchanged. In these transactional messages they are referenced by the GS1 Identifications Keys. The Master Data related to them are retrieved from the company's data base via these ID keys.

The Master Data can be exchanged directly between trading partners, but far more efficient way is to use the Global **Data** Synchronisation Network comprised of:

- **Certified Data Pools** - interoperable electronic catalogues standardised master data, ensuring the confidentiality and integrity of user information.
- **GS1 Global Registry** – acting as the “information directory” identifying where information is held across the network and enabling the uniqueness of the registered items and parties.

User companies (e.g. manufacturers) can publish their Master Data in one of the Data Pools and their trading partners (e.g. retailers) can subscribe to receive notification whenever any of the attributes change or new product descriptions are published. The Data Pools contact the Global Registry to check where the information is stored and synchronise it directly with the Data Pool storing requested information. The relevant subset is then sent to the requesting user.

This infrastructure supporting standards ensure that all participating trading partners have access to most up to date Master Data relevant to them.

For more information about the use of EANCOM® messages in the GDSN, please refer to GS1 website: http://www.gs1.org/gsm/kc/gdsn/eancom_mapping

3. EANCOM® MESSAGES

3.1. Categorisation

The EANCOM® messages can be divided into the following categories:

- **Master data alignment**, messages used to exchange master data related to relevant parties and products between trading partners. The master data is stored in computer systems for reference in subsequent transactions or interchanges.
- **Transactions**, messages used to order goods or services, arrange for transport of the goods, and realise payment for the goods or services supplied.
- **Reporting and planning**, messages used to supply the trading partner with relevant information or future requirements. The acknowledgement of receipt of an interchange and experienced errors is also provided for.
- **Miscellaneous**, messages used for various purposes. They allow the exchange of general application support information and the administration of the exchange of an external object.

3.2. EANCOM® Information Flow

The messages available in the EANCOM® standard cover the functions required to carry out a complete trade transaction: messages which enable the **trade** transaction to take place, (e.g., price catalogue, purchase order, invoice, etc.); messages used to instruct **transport** services to move the goods; and messages used in settlement of the trade transactions through the **banking** system. The flows and trading partners catered for in EANCOM® can be represented as follows:

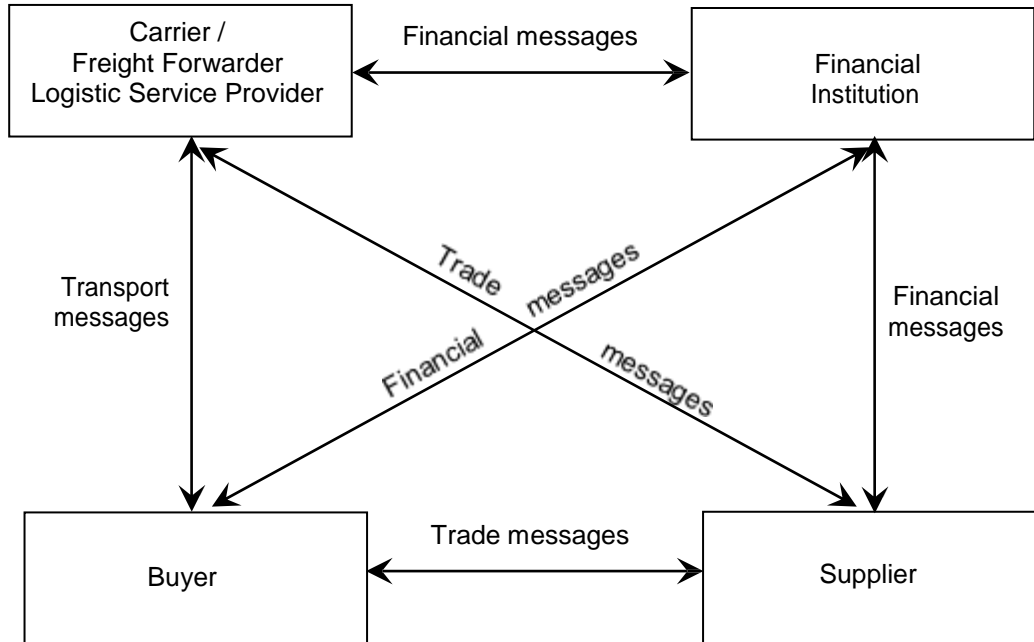

3.3. Master Data Alignment

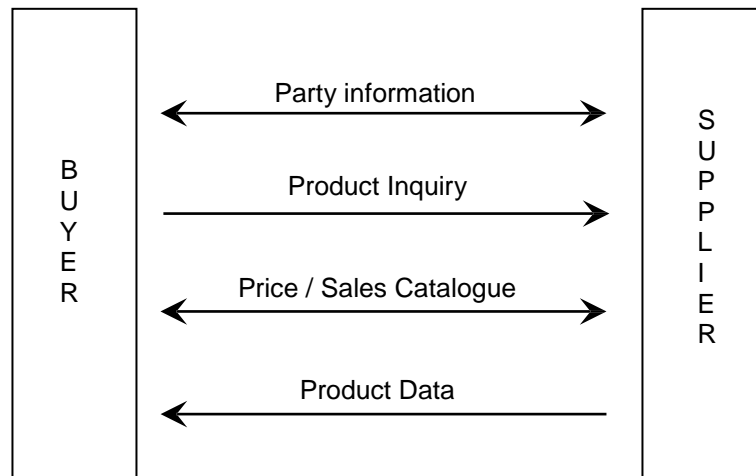

2.3.1. Party Information (PARTIN)

The Party Information message is the first message exchanged between trading partners at the beginning of a commercial relationship. It is used to provide location information and the related operational, administrative, commercial and financial data to the trading partner, (e.g., name and address, contact persons, financial accounts, etc.). The message will be exchanged again if there are any changes or updates to such information at a later stage of the trading relationship, so that the partner's master data files are maintained and kept current.

The Party Information message can also be used by the trading partners to feed a central catalogue of addresses, making the information available to all interested parties.

2.3.2. [Product Inquiry \(PROINQ\)](#)

The Product Inquiry message enables a buyer to inquire on a product or group of products from a master product catalogue according to criteria defined in the message. The buyer may specify in the message the attributes of a product or group of products for which he is interested in receiving additional information. This will allow a manufacturer and/or supplier to send the buyer only information for those products in which the buyer is specifically interested, rather than the entire product catalogue.

The Product Inquiry message may request information in order to select a specific group or family of products from a supplier's entire product catalogue, (e.g., a buyer requesting from a supplier of medical equipment all product information related to sterilised products), select a product or group of products according to attributes or product characteristics as defined by the sender in the message, (e.g., a retailer requesting a clothing manufacturer to send product information for all blue, white or striped men's shirts, sizes medium to extra-large), or determine the availability, lead-time and/or general commercial/sales conditions for a specific product.

The Product Inquiry message may be responded to by a Price/Sales Catalogue and/or Product Data message, depending on the business requirements expressed in the message.

2.3.3. [Product Data \(PRODAT\)](#)

The Product Data message is similar message to the Price/Sales Catalogue message in that it is used to exchange product related information between trading partners. The fundamental difference between the messages is that the Product Data message is used to provide technical and functional data related to products, (e.g., the technical specifications of an electrical product, the ingredients of a cake, etc.), and does not include any commercial terms and conditions. Data exchanged in the Product Data message normally does not change very frequently.

2.3.4. [Price/Sales Catalogue \(PRICAT\)](#)

The Price/Sales Catalogue message is sent by the supplier to his customers. The message is used as a catalogue or list of all of the supplier's products or as an advanced warning to particular changes in the product line. The catalogue would include descriptive, logistical, and financial information about each product. However, the catalogue may also be used to provide technical and functional data related to products, (e.g., the technical specifications of an electrical product, the ingredients of a cake, etc.) as done in the Product Data message.

The message might indicate only general information about the products, valid for all customers or provide a single customer with specific product information such as special pricing conditions. Additionally, the message can be sent from a buyer to a seller to specify special requirements such as buyer labelling or packaging requirements.

The message will be re-sent when there are any changes, deletions or additions to the supplier's products.

The Price/Sales Catalogue message can also be used by suppliers to feed a central catalogue of products, making the information available to all interested parties.

3.4. Transactions

2.4.1. Pre-Order Messages

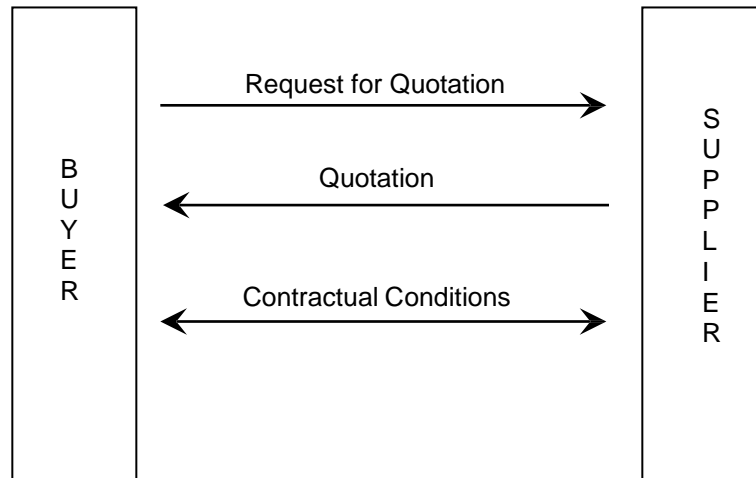

2.4.1.1. [Request for Quotation \(REQOTE\)](#)

The Request for Quotation message is transmitted by the customer to his supplier to request a quotation for the supply of goods or services. The request for quotation may be used to solicit the supplier's payment terms and conditions, and also to specify the required quantities, dates and delivery locations. The message will refer to the location and product codes exchanged previously in the Party Information and Price/Sales Catalogue Messages.

2.4.1.2. [Quotation \(QUOTES\)](#)

The Quotation message is transmitted by the supplier to his customer in response to a previously received request for quotation for the supply of goods or services. The quotation should provide details on all aspects previously requested by his customer. The information sent in a quotation may directly lead to a Purchase Order being placed by the customer.

2.4.1.3. [Contractual Conditions \(CNTCND\)](#)

The message is exchanged between trading parties, providing the contractual conditions of a previously negotiated contract in order to enable the automatic validation of orders and the verification of invoices prior to payment.

This message is typically used in the case where a general contract has been established between parties, against which goods will be ordered over a period of time on an order-by-order basis. The contract will have been previously negotiated and accepted. This message only contains the information which can be used to automatically approve the transmission of an order or the correctness of an invoice.

2.4.2. Order Messages

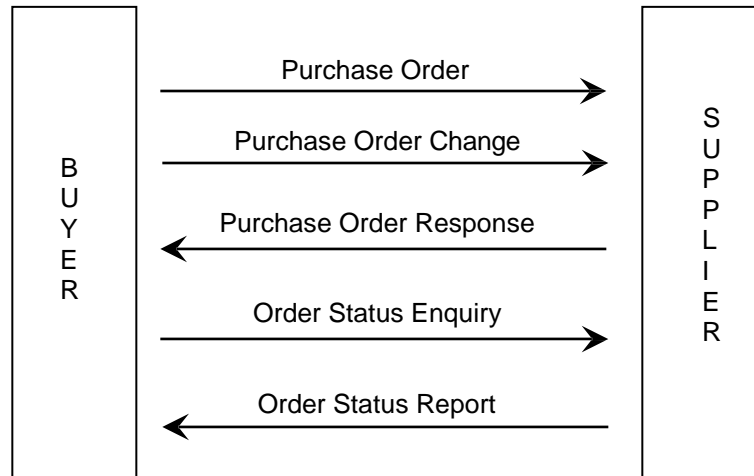

2.4.2.1. Purchase Order (ORDERS)

The Purchase Order message is transmitted by the customer to his supplier to order goods or services and to specify the relevant quantities, dates and locations of delivery. The message may refer to an earlier Quotation received from the supplier for the ordered goods or services. The message will refer to the location and product codes exchanged previously in the Party Information and Price/Sales Catalogue Messages. It is intended to be used for the day-to-day ordering transaction with, as a general rule, one Purchase Order per delivery, per location. However, it is possible to request deliveries at several locations and on different dates.

2.4.2.2. Purchase Order Response (ORDRSP)

The Purchase Order Response is sent by the supplier to his customer in relation to one or more goods items or services to acknowledge the receipt of the Purchase Order, to confirm its acceptance, to propose any amendments, or to notify non-acceptance of all or part of the Purchase Order. The Purchase Order Response may also be used to respond to a Purchase Order Change Request Message. A buyer's Purchase Order may be responded to by one or more response messages according to business practice.

2.4.2.3. Purchase Order Change Request (ORDCHG)

The Purchase Order Change Request is sent by the customer to the supplier to specify the details concerning modifications to a previously sent Purchase Order. The customer may request to change or cancel one or more goods items or services.

The exact information flow with regard to the Purchase Order, the Purchase Order Response and the Purchase Order Change Request messages can vary. The procedures to be followed by the trading partners should be specified in the Interchange Agreement. An example of procedural difference might be not having the supplier send a Purchase Order Response message if there are no modifications to be made to the original order.

2.4.2.4. Order Status Enquiry (OSTENQ)

The Order Status Enquiry message may be sent from a buyer to a supplier to request information on the current status of a previously sent order(s). The message may be used to request status information for a previously transmitted Purchase Order message.

2.4.2.5. [Order Status Report \(OSTRPT\)](#)

The Order Status Report message may be used by a supplier to report the status of an order. This message may be sent as a reply to an Order Status Enquiry sent by a buyer or buyer's agent or a report sent at regular intervals as agreed by the parties. The message may be used to report status information for a previously transmitted Purchase Order message.

2.4.3. Transport and Delivery Messages

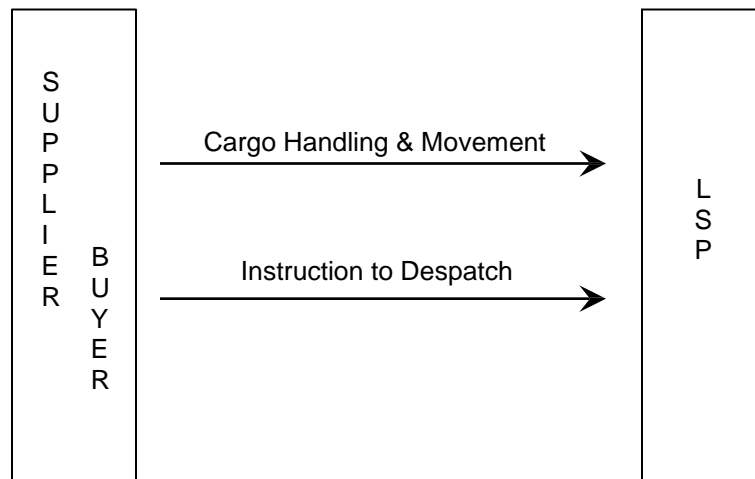

2.4.3.1. [Cargo/Goods Handling and Movement \(HANMOV\)](#)

The Cargo/Goods Handling and Movement message is sent by a party (e.g., buyer or supplier) to a warehouse, distribution centre, or logistics service provider, identifying handling services on products held but not owned by the message recipient, and, where required, the movement of specified goods, limited to warehouses within the jurisdiction of the distribution centre or logistics service provider.

This message addresses the indirect flow of goods between supplier and buyer through a warehouse, distribution centre or logistics service provider and caters for the following functions: the preparation of goods for shipment, the picking of goods according to instructions, the packing or unpacking of goods, the marking and labelling on the packages of goods, and instructions regarding the movement of goods between warehouses.

2.4.3.2. [Instruction to Despatch \(INSDES\)](#)

The Instruction to Despatch message is a message from a party (e.g., buyer or supplier) to another party (e.g., Logistic Service Provider or LSP) who has control over ordered goods, providing instructions to despatch or collect a consignment according to conditions specified in the message. The message may be used to identify the delivery location(s), identify the date(s) on which delivery should take place, indicate that the despatch is subject to cash on delivery, etc.

Because the third party service provider is outside the normal buyer-to-supplier order process, the Instruction to Despatch message may be used by the supplier or buyer to inform the third party service provider of information stated in the purchase order which is required for the effective despatch of the goods, (e.g., terms of delivery, transport equipment required for the delivery), to enable the logistic service provider to produce a despatch advice on behalf of the buyer or supplier.

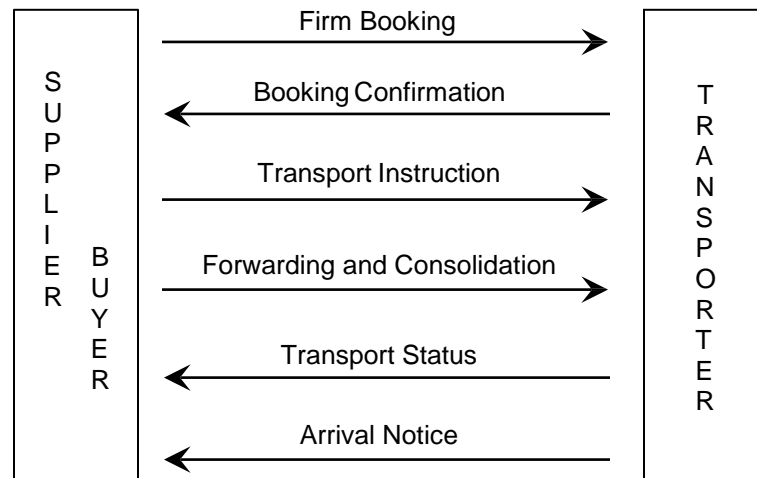

2.4.3.3. [Firm Booking \(IFTMBF\)](#)

The Firm Booking message is a message from a party booking forwarding and/or transport services for a consignment to the party providing those services, containing conditions under which the sender of the messages requires the services to take place. A firm booking message is a commitment from the consignor to the carrier or forwarder to avail himself of certain services, and is used for planning or operational purposes by the carrier or forwarder.

2.4.3.4. [Booking Confirmation \(IFTMBC\)](#)

The Booking Confirmation message is sent from a carrier or forwarder to the consignor booking services, providing confirmation of a booking for a specified consignment. A confirmation may indicate that the booking of a consignment is accepted, pending, conditionally accepted or rejected. The message can be used whenever a confirmation of the booking of a consignment is deemed necessary as an answer to a firm booking message for a specific consignment.

2.4.3.5. [Transport Instruction \(IFTMIN\)](#)

The Transport Instruction is sent by a customer to his supplier of transport services (who may or may not be the supplier of the goods), requesting the transportation of a single consignment of goods to a specified delivery point or points. The instruction may be for one or several goods items which may be specially packaged for transport purposes. Identification of transport packaging may be achieved through the use of the Serial Shipping Container Codes (SSCC).

2.4.3.6. [Forwarding and Consolidation Summary \(IFCSUM\)](#)

The Forwarding and Consolidation Summary message is a message from the party issuing either an instruction or a booking regarding forwarding/transport services for multiple consignments (the equivalent of multiple Transport Instruction messages) under conditions agreed, to the party arranging the forwarding and/or transport services.

The message results in a transport contract for multiple consignments and is primarily meant for administrative purposes. It will be the message from shipper to carrier or forwarder containing the final details of the consignments for which services are provided.

2.4.3.7. [Transport Status \(IFTSTA\)](#)

The Transport Status message allows for the exchange of information regarding the status of the physical movement of consignments or goods at any point (in time or place) within the full transport chain. The message may be sent as the result of a request or requests for information regarding a consignment or consignments, on a scheduled basis at predetermined times, on the occurrence of a selected event or events, or on the occurrence of an exceptional event as agreed by the partners involved.

2.4.3.8. [Arrival Notice \(IFTMAN\)](#)

The Arrival Notice message is sent from the party providing forwarding and/or transport services to the party indicated in the contract (e.g., the consignor), giving notice and details of the arrival of a consignment. The message may also be used to provide proof of delivery information. One arrival notice message should always correspond to one consignment.

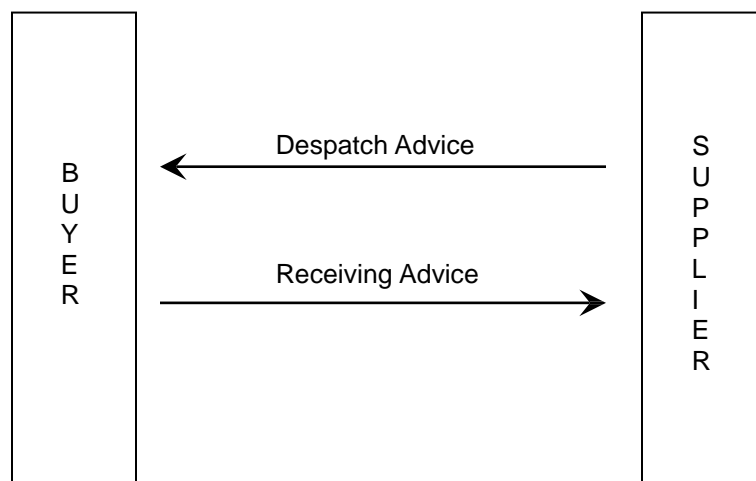

2.4.3.9. [Despatch Advice \(DESADV\)](#)

The Despatch Advice is a message specifying details for the goods despatched under conditions agreed between the buyer and the seller, with the function of advising the consignee of the detailed contents of a consignment. The message relates to a single despatch point and a single or multiple destination points, and it may cover a number of different items, packages or orders. The message allows the consignee to know what materials were despatched and when, allowing the consignee to prepare for receipt of the goods and to cross-check the delivery with the order.

The Despatch Advice may be sent for either the despatch of a delivery consignment of goods or the despatch of a return consignment of goods. Identification of transport packaging may be achieved through the use of the Serial Shipping Container Codes (SSCC).

2.4.3.10. [Receiving Advice \(RECADV\)](#)

The Receiving Advice is a message specifying details for the goods received under conditions agreed between the buyer and the seller, with the function of advising the consignor of the received contents of a consignment. The message relates to a single receiving point and a single despatch point and it may cover a number of different items, packages or orders. The message allows the consignor to know what materials were received/not received against the original order and what materials were accepted/not accepted. This information allows the consignor to prepare an invoice for the customer.

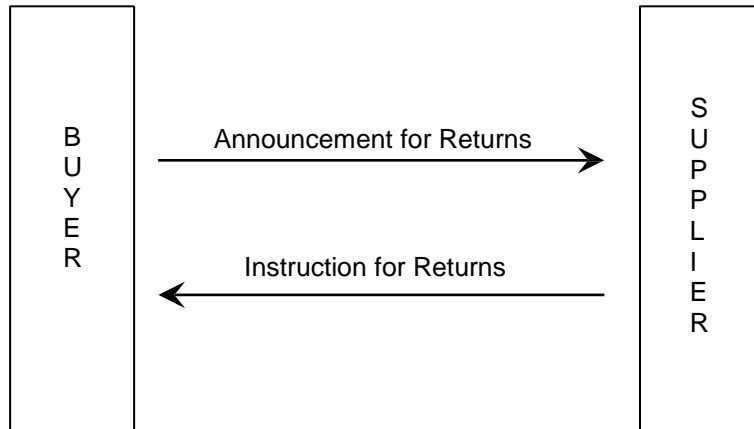

2.4.3.11. Announcement for Returns (RETANN)

The Announcement for Returns message is used by a party to announce to the other party details of goods for return due to specified reasons (e.g. returns for repair, returns because of damage, etc.). The message may be used by the message sender to request credit for goods, or the replacement of goods from the message recipient due to a problem with the goods (e.g., goods received in bad condition, goods received but not ordered, unsold goods which have exceeded their expiry date, etc.) discovered after the delivery process has been completed (i.e., the goods have been received and checked at case level and a Receiving Advice has been issued).

2.4.3.12. Instructions for Returns (RETINS)

The Instructions for Returns message is the means by which a party informs another party whether and how goods shall be returned. The sender of an instruction for returns message will normally have previously been informed by the recipient of the intention to return goods by means of the Announcement for Returns message.

The Instruction for Returns message may be used to inform a party if the sender refuses, or does not require, return of the goods. Where the message sender does not require the return of goods, the message may indicate what action the message recipient should carry out (e.g., disposal, destroy). Where the message sender refuses the return of goods, the reason for the refusal may be provided.

2.4.4. Payment and Financial Messages

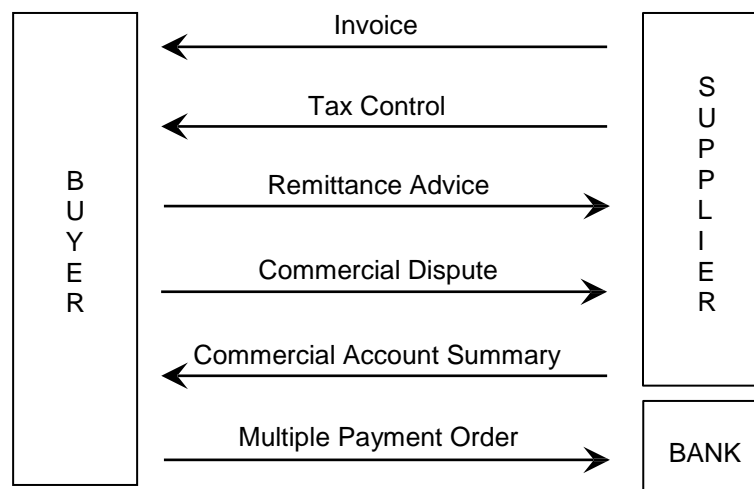

2.4.4.1. Invoice (INVOIC)

The Invoice message is sent by the supplier to the customer claiming payment for goods or services supplied under conditions agreed by the seller and the buyer. This same message with correct data qualification also covers the functions of pro-forma invoice, debit and credit note. The seller may invoice for one or more transactions referring to goods and services related to one or more order, delivery instruction, call off, etc. The invoice may contain references to payment terms, transport details and additional information for customs or statistical purposes in the case of cross-border transaction.

2.4.4.2. Tax Control (TAXCON)

The Tax Control message may be sent by the supplier to the customer summarising the tax related information for an invoice or batch of invoices. Generally, it accompanies the actual invoice or batch of invoices. The message may also be sent by either party to third parties, auditors, and tax authorities in summary form to detail the tax information over a period of time.

2.4.4.3. Remittance Advice (REMADV)

The Remittance Advice is a communication between buyer and seller which provides detailed accounting information relative to a payment, or other form of financial settlement, on a specified date for the provision of goods and/or services as detailed in the advice. The message may be initiated by either the buyer or seller. The Remittance Advice is a notice of payment to be made, both national and international, covering one or more transactions. Each Remittance Advice is calculated in only one currency and relates to only one settlement date. References to payment orders may be included.

2.4.4.4. Multiple Payment Order (PAYMUL)

A Multiple Payment Order is sent by the Ordering Customer (normally the Buyer in EANCOM®) to its bank, to instruct the bank to debit one or more accounts it services for the Ordering Customer, and to arrange for the payment of specified amounts to several Beneficiaries (normally the Supplier in EANCOM®) in settlement of the referenced business transaction(s). The Multiple Payment Order may cover the financial settlement of one or more commercial trade transactions such as invoices, credit notes, debit notes, etc.

2.4.4.5. Commercial Account Summary (COACSU)

The Commercial Account Summary message enables the transmission of commercial data concerning payments made and outstanding items on an account over a period of time. The message may be exchanged by trading partners or may be sent by parties to their authorised agents (e.g., accountants).

2.4.4.6. Commercial Dispute (COMDIS)

The Commercial Dispute message is a notice of commercial dispute against one or more INVOIC messages (e.g., commercial invoice, credit note, etc.), which is usually raised by the buyer to notify the supplier that something was found to be wrong with an INVOIC message which detailed goods delivered or the services rendered (e.g., incorrect price, incorrect product identification, no proof of delivery, etc.).

The buyer may use the message to supply the following information; non-acceptance of an Invoice message containing errors, with a mandatory indication of error(s) providing the reason for non-acceptance and an indication of the corrections to be made, or, acceptance of an Invoice message containing errors and, if necessary, an indication of error(s) and an indication of the corrections to be made.

3.5. Report and Planning

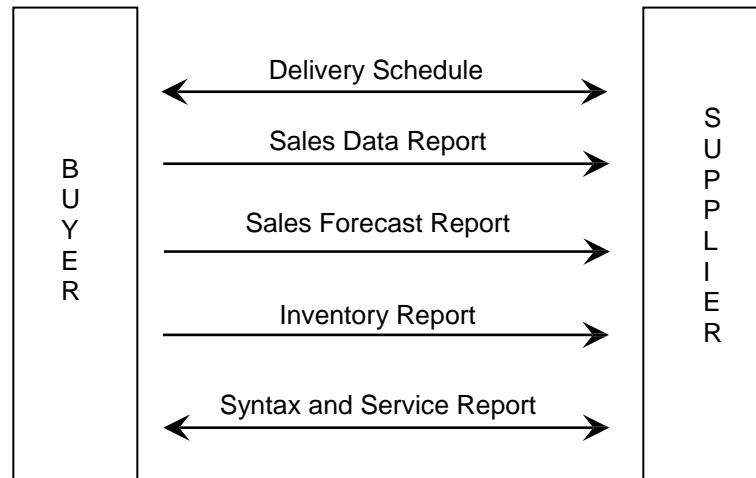

2.5.1. [Delivery Schedule \(DELFOR\)](#)

The Delivery Schedule is a message from a customer to his supplier providing product requirements for short term delivery instructions and/or long term product/service forecasts for planning purposes. The message can be used to authorise the commitment of labour and material resources. The message may provide schedules in two manners by location, or by product. The message may also be sent by a supplier to a buyer in response to a previously transmitted delivery schedule.

In its simplest form, a location delivery schedule allows the user to specify one location and multiple products which are/will be required for that location. The simple product schedule allows the identification of one product which is/will be required in multiple locations.

2.5.2. [Sales Data Report \(SLSRPT\)](#)

The Sales Data Report message, sent from a seller to his supplier, headquarters, distribution centre or third party such as a marketing institute, enables the transmission of sales data in a way that the recipient can process automatically. The message transmitting sales data by location in terms of product(s) identification, quantity sold, price, and promotions applicable can be used for production planning or statistical purposes. It should not be used to replace business transactions such as orders or delivery schedules.

2.5.3. [Sales Forecast Report \(SLSFCT\)](#)

The Sales Forecast Report message, sent from a seller to his supplier, headquarters, distribution centre or third party, enables the transmission of sales forecast data in a way that enables the recipient to process it automatically. The message transmitting sales forecast data by location in terms of product identification, forecasted quantities and promotions applicable can be used for production planning purposes. It should not be used to replace business transactions such as orders or delivery schedules.

2.5.4. [Inventory Report \(INVRPT\)](#)

The Inventory Report is a message between interested parties, specifying information related to planned or targeted inventories. All goods, services and locations detailed in the inventory report will have been previously identified in the Party Information and Price/Sales Catalogue Messages. Different classes of inventories may be identified which may also be financially valued. Quantities may relate to model or target quantities, minimum/maximum levels, reordering levels and held stocks.

2.5.5. [Syntax and Service Report Message \(CONTRL\)](#)

The Syntax and Service Report Message is used by the receiver of an EANCOM® message to acknowledge receipt of and/or detail any errors contained in an interchange. This message is used to report on the syntax level of a message and is not used to report on the business data contained.

The Syntax and Service Report may be carried out by a third party, (i.e., a value added network), operating on behalf of the trading parties.

2.5.6. [Application Error and Acknowledgement \(APERAK\)](#)

This message is sent from the party who received an original message, to the party who issued the original message, to acknowledge to the message issuer the receipt of the original message by the recipient's application and to acknowledge errors made during the processing within the application.

The message should be generated by the application software — NOT by EDI-translator software — and must NOT be used to acknowledge the receipt of an interchange (see Syntax and Service Report).

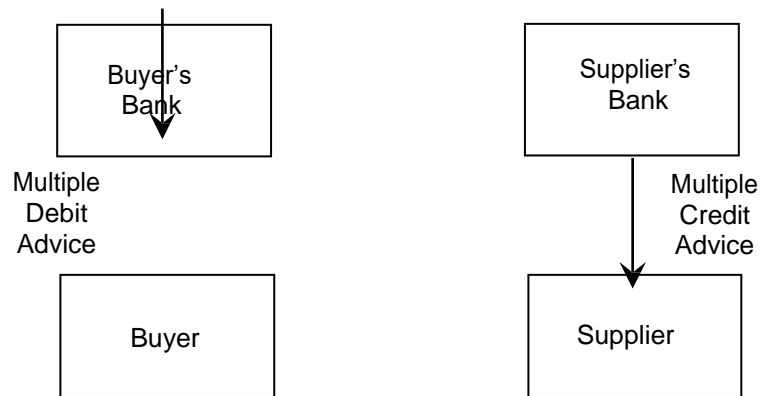

2.5.7. [Multiple Debit Advice \(DEBMUL\)](#)

The Multiple Debit Advice message is sent by a Bank to its customer (normally the Buyer in EANCOM®) to report amounts which have been (or will be) debited from the customer's account in settlement of a referenced business transaction(s). A Multiple Debit Advice message may cover the financial settlement of one or more commercial trade transactions, such as invoices, credit notes, debit notes, etc.

2.5.8. [Multiple Credit Advice \(CREMUL\)](#)

The Multiple Credit Advice message is sent by a Bank to its customer (normally the Supplier in EANCOM®) to report amounts which have been (or will be) credited to the customer's account in settlement of a referenced business transaction(s). A Multiple Credit Advice message may cover the financial settlement of one or more commercial trade transactions, such as invoices, credit notes, debit notes etc.

2.5.9. [Banking Status \(BANSTA\)](#)

The Banking Status message is sent by a bank to its customer (usually the Buyer in EANCOM®), providing status information regarding a previously sent financial message. The Banking Status message may cover the response given to any previously sent message, such as a commercial or payment instruction, a request for information, etc. This message provides a means to report on errors and inconsistencies found in the original message at application level. It is not intended to report on syntactical errors or to provide a non-repudiation response.

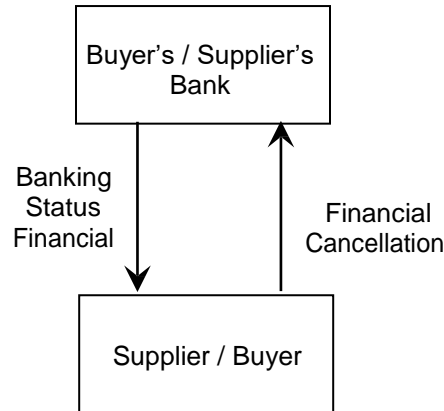

2.5.10. [Financial Cancellation \(FINCAN\)](#)

A Financial Cancellation message is sent by the Ordering Customer (usually the Buyer in EANCOM®) to the Ordered Bank to request cancellation of a previously sent financial message(s), or one or many orders contained within a previously sent financial message(s). A Financial Cancellation message must always be responded to by a Banking Status message.

2.5.11. [Financial Statement \(FINSTA\)](#)

The Financial Statement message is sent by a financial institution to provide for a customer a statement of booked items confirming entries on the customer's account.

2.5.12. [Direct Debit \(DIRDEB\)](#)

A Direct Debit is sent by the Creditor to the Creditor's Bank instructing the latter to claim specified amount(s) from the Debtor(s) and to credit the amount(s) to an account specified in the message, which the Creditor's Bank services for the Creditor in settlement of the referenced transaction(s).

2.5.13. [Metered Services Consumption Report \(MSCONS\)](#)

A Metered Services Consumption Report is a communication between trading parties, or their agents, providing consumption and where required associated technical information at a location(s) for a product(s) or service(s) where the supply is recorded using a meter(s). The Metered Services Consumption Report may be used to provide consumption information which may directly relate to other business functions, (e.g., invoicing or process control).

2.5.14. [Quality Test Report \(QUALITY\)](#)

A message to enable the transmission of the results of tests performed to satisfy a specified product requirement. The content includes, but is not limited to, test data and measurements, statistical information, and the testing methods employed.

3.6. Miscellaneous

2.6.1. [Drawing Administration \(CONDRA\)](#)

This message will be used for the administration of each exchange of an external object. For example, an external object may be a photograph, a video, a film, a CAD file. The message will give additional

information about the object and it will refer to the message, and if necessary to the line number to which it is related.

2.6.2. General Message (GENRAL)

The General Message may be used to send required data for which there is no specific standard message. It was designed primarily to facilitate early transmission testing between new EDI partners or to transmit text (preferably structured or coded) to supplement or further clarify previously transmitted EDI standard messages.

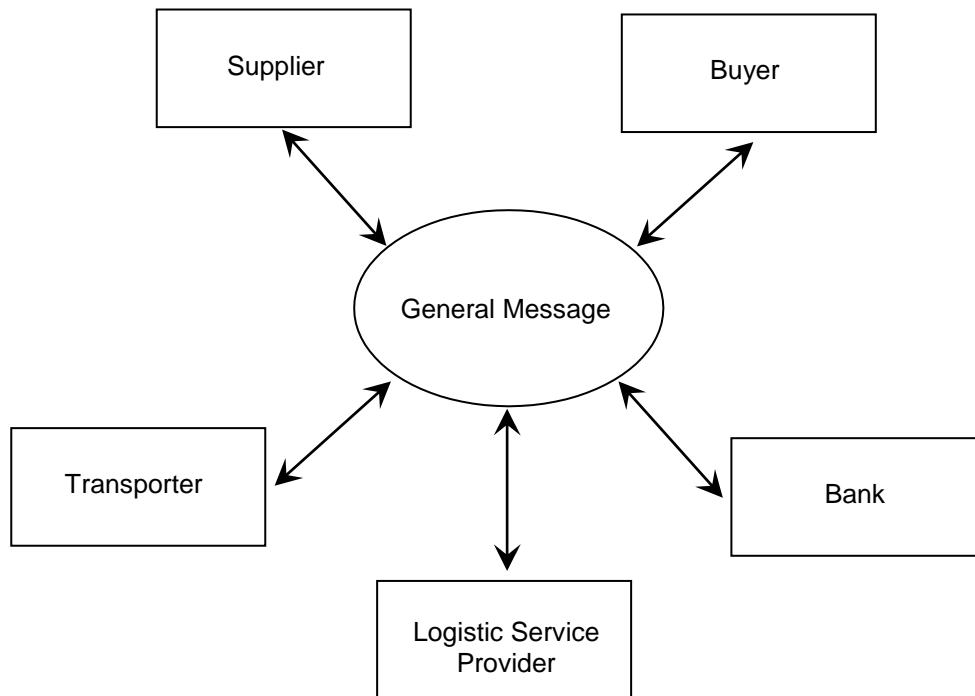

4. MAINTENANCE AND IMPLEMENTATION OF EANCOM®

4.1. Maintenance Aspects

3.1.1. Policy

In terms of future maintenance and processing of new user requirements, work requests will be processed only against the EANCOM® 2002 standard.

3.1.2. Processing a Work Request (WR)

When implementing EANCOM®, user companies might find that some business requirements are not met. They might wish to enhance the standard and draft proposals for new codes, data elements, segments or messages, covering their genuine requirements.

The following procedure is applicable when changes or additions to EANCOM® are requested:

1. A Work Request drafted by a user company must be addressed to the GS1 Member Organisation (MO) where the company is registered.
2. All Work Requests **must conform** to the following criteria before being submitted to the GS1 Member Organisation:

Type of change	Requirements
Addition of new segment	<p>Identification of the message and the position within the message where the segment is to be added.</p> <p>Changes requesting the addition of new segments to an EANCOM® message MUST be supported by a proposal as to the data elements required in the segment and their statuses, as well as the code values required for use with the data elements.</p> <p>User community is informed about the addition of the new segment when the new EANCOM® edition is published (see 3.2.5).</p>
Addition of a new code value to the code list for use in all messages	<p>Identification of the data element for which the code is to be added and the segment in which the code is proposed for use.</p> <p>Changes requesting the addition of new codes to EANCOM® (i.e., ones that do not exist in the currently used UN/EDIFACT directory) MUST be supported by a clear definition of the code. Under no circumstances will a code with a definition of 'self explanatory' be accepted for inclusion in EANCOM®.</p>
Addition of a new code value to the code list for use in a specific segment within a specific message	<p>Identification of the message, segment, and data element in which the change applies.</p> <p>Changes requesting the addition of new codes to EANCOM® (i.e., ones that do not exist in the currently used UN/EDIFACT directory) MUST be supported by a clear definition of the code. Under no circumstances will a code with a definition of 'self explanatory' be accepted for inclusion in EANCOM®.</p>

3. The MO will assess the WR and, if no solution is available within the current EANCOM® manual, enter it into the GS1 Global Standards Management Process (GSMP).
4. The MO will inform the submitter on the GSMP outcome.

3.1.3. Code List Publication

A new edition of the GS1 EANCOM® 2002 Manual is published every two years. It contains changes made in the standard based on Work Requests processed up to the end of the year preceding the publication, e.g. Edition 2010 contained changes accepted up to the end of 2009, while Edition 2012 contained changes accepted up to the end of 2011.

The codes added in periods between the editions are published on GS1 website. It is important to note that they can only be implemented under a bi-lateral agreement among the trading partners. It must be clearly stated in the interchange contract that the additional functionality is agreed to be used as an add-on to the functionality provided in the EANCOM® 2002 standard.

4.2. Implementation Aspects

3.2.1. Publications

The implementation of an EDI project involves many detailed steps. GS1 has published more detailed documents introducing scenarios for each EANCOM® message and guidelines on how they should interact. Currently available documents can be found on the GS1 website

<http://www.gs1.org/ecom/standards/guidelines#eancom>.

3.2.2. EANCOM® Manual

The EANCOM® manual is distributed via the GS1 Member Organisations. Interested companies should contact their local [Member Organisation](#) to obtain additional copies of the documentation and further information.

It is important that EANCOM® users are properly identified, to keep them abreast of the evolution of the standard and provide them with all relevant documentation.

3.2.3. EANCOM® and Data Alignment

The effective and efficient use of EANCOM® messages relies on data accuracy. Parties involved in an EDI transaction must be able to use and interpret data consistently. Establishment of aligned data between trading partners is the recommended first step in any EANCOM® implementation, as this alignment will greatly increase efficiency and accuracy at later stages in the trading relationship. The alignment of data between trading partners, and the later use of the GTIN and the GLN provides EANCOM® users with the opportunity to reengineer their processes by removing any data or activities which may be superfluous at certain steps in the supply and data chain.

3.2.4. EANCOM® Translation Tables

One of the first steps to be taken in an EANCOM® implementation is the creation of EANCOM® translation tables, which are used to map application data into the EANCOM® messages. Such mapping tables act as an intermediate step between the in-house application and the EDI translator software. While it is possible to create EDI software translation tables which are specific to each trading relationship, this is not recommended since separate translator tables would be required, should you wish to extend your EDI trading links to other parties from other industry sectors. In order to avoid this potential problem, it is strongly recommended to use a translator table which supports the full EANCOM® message structure.

Such a decision will protect your translator investment, should you wish to extend your EANCOM® links in the future.

3.2.5. Support of Message Versions

A condition for successful implementation of EDI is the stability of the standard used, including the syntax, the messages, the data elements and definition of codes. The shortest period between two versions of EANCOM® messages has been set to two years.

As it is unlikely that all trading partners will migrate to the next version at the same time, it is recommended that users should be able to handle concurrently more than one version of the same message i.e. the latest and preceding versions.

5. SPECIFIC RULES

5.1. Identification of trade items

Each trade item, "item" being defined in the widest possible sense, is uniquely identified by a Global Trade Item Number (GTIN). This number is part of the common vocabulary adopted by the partners who are exchanging standard messages. See also section 1.3.2.

The format and use of a GTIN are described in the GS1 General Specifications and on the [GS1 website](#).

4.1.1. Variable quantity trade items

A number of products are purchased and sold in variable quantity. In scanning applications, an internal numbering structure is generally used by the retailers for marking those products. This structure includes either the price or the weight of the item, making it possible to charge the correct price to the customer at a retail check-out.

In EDI messages, however, it is necessary to identify those items in a generic form for ordering, delivering and invoicing. The recommendation in EANCOM® is to assign to each variable quantity product a GTIN and to refer to this number in data interchanges.

The facility to indicate the actual quantity and price in the appropriate unit of measure is provided in the EANCOM® messages.

A specific code - "VQ = Variable quantity product" - can be used in the IMD segment (Item Description) to specify this type of product. It is especially recommended to indicate this product characteristic in either the Price/Sales Catalogue or Product Data message.

4.1.2. Mixed Assortments

It is a common business practice to sell and purchase some products in mixed assortments. Mixed assortments contain a standard grouping of different products. According to the GS1 rules, mixed assortments are identified by a GTIN.

It is recommended to first describe mixed assortments using the Price/Sales Catalogue message by indicating in the LIN/PIA/QTY/PRI segment the identity of the mixed assortment, and in the IMD segment the coded description of a standard group of products.

For the Purchase Order and Invoice messages, three alternative solutions are available:

1. Indicate the GTIN of the assortment in a combination of LIN/PRI/QTY segments. In this case prices and quantities refer to the assortment, not to individual products.
2. Use a different combination of LIN/PRI/QTY segments for each individual product which is part of the assortment. Prices and quantities refer to the individual products.
3. Indicate the GTIN of the assortment and all the GTINs of each individual product using sub-lines. In the purchase orders, GTIN of the mixed assortment is used by clients to order this product but in the invoice, it may be required to specify all the individual products.

Ordering a mixed pack or assortment

The following is an example of a Purchase Order message ordering a set or mixed pack already known by the recipient of the information.

The buyer sending the message is identified by the GLN 4012345500004. The supplier is identified by the GLN 5412345000020.

The message sent on 1 January 2002, bearing the reference number PO12123, is ordering the product, "First Aid Kit", consisting of three products with different quantities.

The first aid kit is configured as follows:

First aid kit (article being ordered)	Quantity ordered	Articles contained within the first aid kit	Quantity of each article contained in first aid kit (quantities communicated only in a previous PRICAT message)
5410738251028	5000	8711112000001	4
		8711111000002	8
		8711113000000	1

In this example, where 5000 units of the first aid kit are ordered, it must be remembered that the ordering of the first aid kit will by default pick up the contents of the kit, and that the quantity of each of the products contained in the kit will be multiplied by the order quantity.

```

UNH+ME000055+ORDERS:D:01B:UN:EAN010'
BGM+220+PO12123+9'
DTM+137:20020101:102'
NAD+BY+4012345500004::9'
NAD+SU+5412345500020::9'
LIN+1++5410738251028:SRV' . Main line 1: mixed pack
QTY+21:5000' . Quantity ordered 5000
UNS+S'
CNT+2:1'
UNT+10+ME000055'
  
```

4.1.3. Promotional variants (PIA)

Product variants can be used in communications to identify promotional or other actions which do not require the allocation of a different GTIN. In this case, a 2-digit product variant is used in addition to the main GTIN.

In EANCOM®, the promotional variant number is indicated in segment PIA, using the appropriate code value of the item type identification code (DE 7143 = PV).

5.2. Identification of logistic units (PCI/GIN)

Tracking and tracing of logistic units in the supply chain is a major application of the GS1 System. Scanning the standard identification number, marked on each logistic unit, allows the physical movement of units to be individually tracked and traced by providing a link between the physical movement of items and the associated information flow provided by EANCOM® messages.

Logistic units are defined as physical units established for transport and storage of goods of any kind which need to be tracked and traced individually in a supply chain. The requirement for logistic units is that they are identified with a standard GS1 identification number known as the Serial Shipping Container Code (SSCC). The SSCC enables the unrestricted circulation of the units, as the construction of the SSCC ensures that they are identified with a number that is unique world-wide. See also section 1.3.2.

The Serial Shipping Container Code is detailed in the GS1 General Specifications and on the [GS1 website](#).

5.3. Identification of parties and locations (NAD)

The unique identification of the trading partners is critical when applying EDI. It is more important to identify locations precisely and unambiguously with EDI than with traditional paper documents.

The identification of parties and locations within EDI messages is the primary application for the GLN. Within EANCOM®, a message and a number of segments exist for the purpose of identifying parties. See also section 1.3.2.

The Global Location Number (GLN) is explained in detail in the GS1 General Specifications and on the [GS1 website](#).

Party Information (PARTIN)

The Party Information (PARTIN) message is the first message exchanged between trading partners at the beginning of a commercial relationship. It is used to associate the GLN with location information and the related operational, administrative, commercial and financial data to the trading partner, (e.g., name and address, contact persons, financial accounts, etc.).

This message is used to capture the GLN on a trading partner file. Subsequent messages to the PARTIN message must use the GLN to identify parties and locations.

Interchange Header segment (UNB)

The UN/EDIFACT Interchange Header segment (UNB) is used in all EDI interchanges complying with the UN/EDIFACT syntax rules. The identity of the sender and receiver of the interchange must be specified in this segment. The use of the GLN is mandatory in EANCOM® for the identification of EDI parties at this level.

5.4. Date, time and period (DTM)

Date, time, and period information is provided in the DTM segment which appears in all EANCOM® messages. The EANCOM® recommended format for dates is CCYYMMDD, where all dates which include a year element (YY) are preceded by the century element (CC). Various formats may be indicated through the use of the qualifier in data element 2379 of the DTM segment.

Time is always indicated in the local time of the sender of the message.

To indicate a period of time only one occurrence of the DTM segment with appropriate code values in data elements 2005 and 2379 is required. When indicating the actual dates of the period they should be represented in the format CCYYMMDDCCYYMMDD with the first occurrence of CCYYMMDD indicating the start date of the period.

Examples:

DTM+2:20020201:102'	Indicates the requested delivery date (2) as being the 1st of February 2002, expressed in format: CCYYMMDD (102).
DTM+134:200202151300:203'	Indicates the fact that the rate of exchange (134) was quoted on the 15th of February 2002 at 1pm, expressed in format: CCYYMMDDHHMM (203).
DTM+325:2002020120020210:718'	Indicates the tax period (325) as being from the 1st of February 2002 to the 10th of February 2002 inclusive, expressed in format: CCYYMMDD-CCYYMMDD.

5.5. Free text (FTX)

In general, free text should be avoided in EDI messages. In computer-to-computer exchanges, such text will normally require the receiver to process this data manually.

However, it is acknowledged that free text will be required in some instances and provision has been made in EANCOM® messages for such free text. This allows the sender to include general information in the EDI messages. The free text should never replace missing coded data nor contain instructions on how the message should be processed.

Within EANCOM® it is possible to replace frequently transmitted free text information with coded references to this frequently exchanged text. This is achieved through the use of code values agreed on a bilateral basis between trading partners and communicated in the composite data element C107 in the FTX segment. The use of coded references to free text will reduce the possibility for errors in the free text and enhance the automatic processing possibilities of such information.

It is recommended to limit as much as possible the usage of free text in EANCOM® interchanges.

5.6. Item descriptions (IMD)

4.6.1. Formats

Within EANCOM® it is possible to provide item descriptions in four formats:

- coded
- free form
- coded and associated supplementary free form
- structured

The distinction made between coded and structured format only applies to the internal structure of an industry code list. If coded, a code value unlocks a name and definition in clear text; if structured, a code value unlocks an ordered set of descriptive terms. As such, the population of the IMD segment for a coded and structured format is identical.

4.6.2. Segment structure

The IMD contains 6 data elements specifying the following information:

- **7077** – format of a description
- **7081** – typical product feature, property or quality of an item for which a description is provided
- **7009** – item description code taken from an industry code list
- **7008** – free form description
- **3453** – language of a free form description
- **3055** – the agency responsible for an industry code list

4.6.3. Segment population

Description format	Coded	Structured description	Coded & associated supplementary free form	Free form
DE 7077 value	C	S	B	A, D, E or F
DE 7081 value	Optionally product characteristics			
DE 7008 value	Not used	Not used	Actual free form description	Actual free form description
DE 7009 value	actual description code	actual description code	actual description code	Not used
DE 3055 value	industry code list responsible agency	industry code list responsible agency	industry code list responsible agency	Not used
DE 3453 value	Not used	Not used	Optionally language of the free form description	Optionally language of the free form description

Examples:

IMD+C++TU::9'

Indicates that the description format is coded, from an industry code list (C), code list managed by GS1 (9), code value is Trade Unit (TU)

IMD+F++:::CORN CRISPS:CASE'

Indicates that the item is described by a free form short description (F) and the two parts of description are: Corn Crisps and Case.

4.6.4. Segment repetition and sequencing

The full description of an item may require a number of repeats of the segment.

For each description format one usage of the segment is needed. Also if a free form description has to be provided in different languages, the segment must be repeated.

4.6.5. Data alignment

The full description of an item has to be provided during master data alignment between the trading partners. In subsequent interchanges it is not recommended to send this type of information unless imposed by the business context e.g. Customs rules and regulations. Wherever possible the use of a description code is recommended.

5.7. Currencies (CUX)

Provision has been made in EANCOM® messages to indicate, where relevant, the currency in which the amounts are expressed.

For every interchange, it is recommended to indicate explicitly the currency used in each message. The CUX segment serves this purpose. Only one occurrence of the CUX segment is required to indicate the reference currency, the currency in which all amounts are expressed, and the target currency, (into which the reference currency will be converted). The rate of exchange between the reference and target currencies is also detailed in the single occurrence of the CUX segment.

CUX+2:EUR:8'	Indicates that the reference currency (2), EURO is the price list currency (8)
CUX+2:EUR:8+3:USD:11+0.90243'	Indicates that the reference currency (2), EURO is the price list currency and that the target currency (3), US\$, is the payment currency (11); the rate of exchange between the two is 1 EURO to 0,90243 US Dollar

Currency codes to be used are defined in the ISO 4217 standard as well as in the code list for data element 6345.

5.8. Standard allowances and charges (ALC)

The specification of multiple levels of allowance and charge information is possible in the EANCOM® commercial messages at message, group (only PRICAT), and product detail levels. This is achieved through the use of the ALC segment group, which normally will contain additional segment groups in which the actual allowances or charges are specified (e.g., QTY-RNG, MOA-RNG, etc).

Where a message, product group, or individual product is subject to multiple levels of allowances or charges, (e.g., 10% on purchases between 1000 and 2000 units, 10000 EURO for handling charges, etc.), it is recommended that each individual allowance or charge is expressed in separate repeats of the ALC group, with the actual allowance or charge details specified in the sub-groups beneath the ALC segment.

In addition, it is of vital importance where multiple levels of allowances or charges exist that the sequence in which they are to be processed is indicated in order to ensure the correct result of the application of the allowances and charges. This is achieved through the use of data element 1227 in the ALC segment.

Examples:

ALC+A+++1+ADS'	Allowance (A) for ordering a full pallet (ADS) is to be processed first (1)
PCD+12:15'	Discount (12) is 15 percent
ALC+A+++2+TD'	Allowance (A) for trade discount (TD) is to be processed second (2)
MOA+204:4000:EUR'	Allowance amount (204) of 4000 EURO



Note: Allowances and charges in the heading section of a message are independent from those in the detail section, e.g. ALC at detail level does not override ALC at heading level.

5.9. Temporary codes, use of DE 3055 and 1131

Several codes within the EANCOM® code lists are identified as being temporary code values through the use of '(GS1 Code)', immediately after the code name. These code values do not exist in the most recent UN/EDIFACT code lists at the time of preparation of the EANCOM® manual. In many instances the data element containing the temporary code value will be followed within a composite data element by data element 3055. This data element 3055 allows the explicit identification of the agency responsible for the temporary codes.

When GS1 codes are used in coded UN/EDIFACT data elements which exist in composite data elements containing data elements 1131 and 3055, the code value '9 = GS1' must be used in data element 3055 to identify unambiguously the fact that a temporary code is being used. All DE 3055 were set to status "D" and all DE 1131 to status "O", except data element groups with restricted codes, (e.g. BGM C002).

Example:

Within all LOC segments, DE 3055 must only be used if DE 3225 is used and does not contain a UN/LOCODE.

DE 3225	DE 3055	Code list responsible agency
GLN	9	GS1
UN/LOCODE	Not used	UN/Location code
UN/ECE	6	United Nations – Economic Commission for Europe
IATA	3	International Air Transport Association

All temporary codes for which an UN/EDIFACT code list exists will be forwarded to UN/CEFACT for inclusion. It must be noted however that the code values allocated by UN/CEFACT will normally not be the same as the temporary code values given and that some realignment may be needed when formal UN/EDIFACT codes are issued.

5.10. Sub-lines in EANCOM® messages

Identification of products is carried out through the use of the EANCOM® Price/Sales Catalogue (PRICAT) message. Wherever possible, all products or services should be uniquely identified by means of a Global Trade Item Number (GTIN) and transmitted as a line item in the LIN segment, even if they comprise other products identified by GTIN.

That being said, it is also possible to identify the constituent parts of a product (e.g., hamper containing multiple different products) through the use of sub-lines in some EANCOM® messages, for instance, PRICAT, ORDERS and INVOIC. Sub-lines should be used only to identify the relationship between a number of products, not the complete product itself.

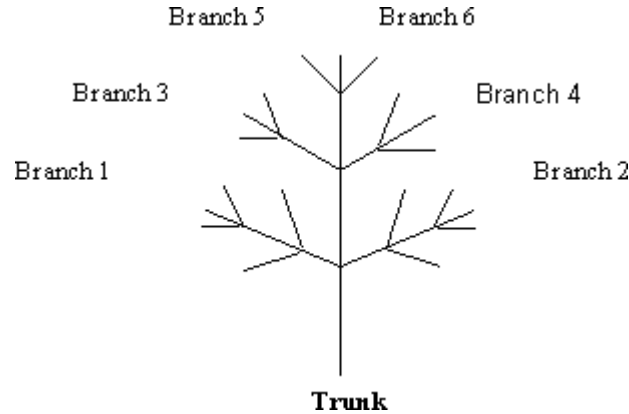

The sub-line facility enables a party to communicate a complete product configuration as a tree like structure. As with physical trees there is always only one trunk, in this instance the base article, with many branches containing many smaller branches. The branches in this analogy could relate to components and sub-components of a product.

In this simple representation of a tree there is one trunk and 6 main branches. On branches 1, 2, 3, and 4 there are sub-branches. It is not possible to get to any of the sub-branches without going first via the trunk and parent branch. The same restriction is true when using sub-lines in the EANCOM® messages, you cannot access a sub-line without first accessing the line at the level immediately above.

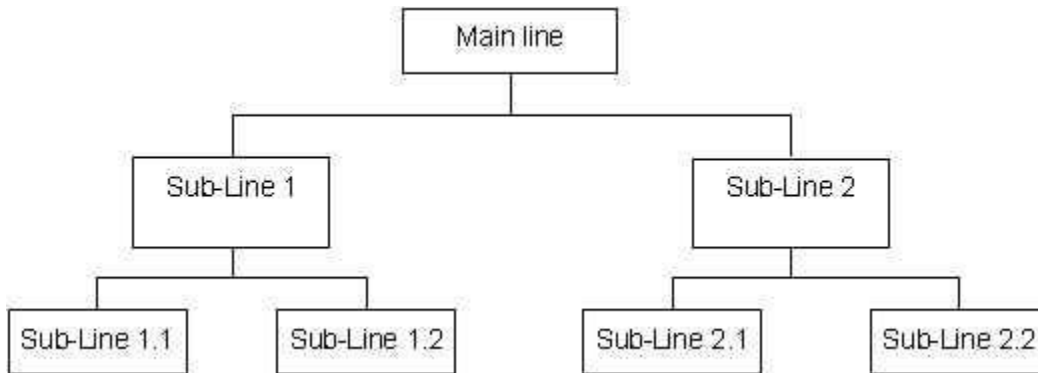

Every EANCOM® message contains a message reference and a line number which are unique to that message and enable the recall of information in subsequent EANCOM® messages and the creation of application databases. Within the EANCOM® messages the creation of complex configurations is achieved through the linking of EANCOM® main line numbers using the sub-line function within the LIN segment. Within EANCOM® it is recommended that the line numbers used in the first occurrence of data element 1082 in the LIN segment be sequential, starting at 1 for each new message. A simple example which details the structure presented above follows hereafter:

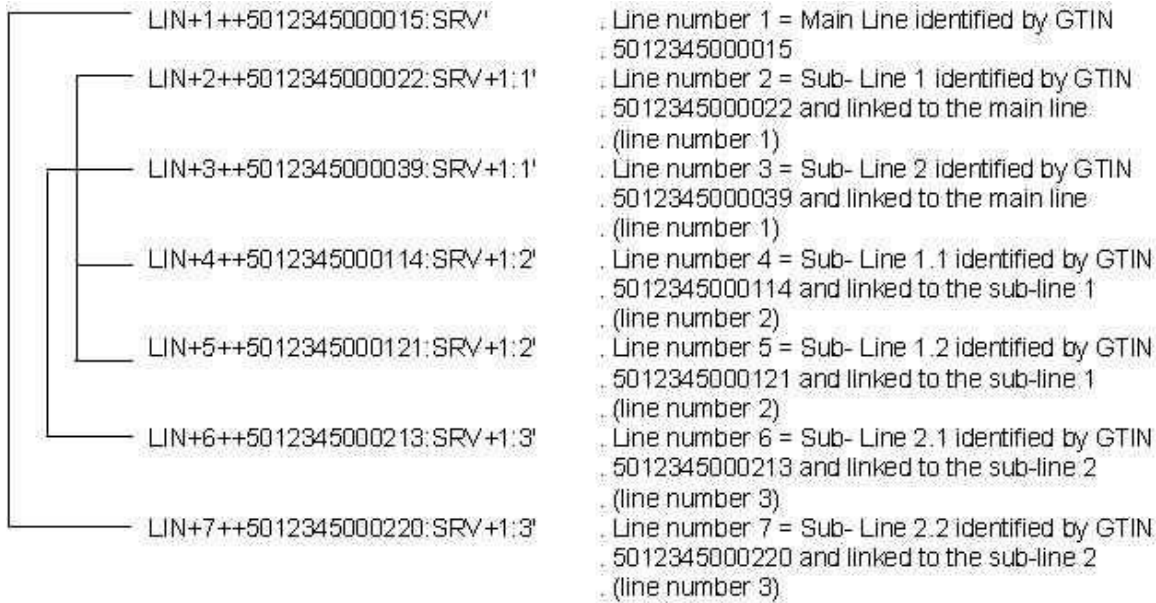

A brief description of the data elements which identify the sub-line follows:

Sub-line information (C829): The composite data element C829 is used to group the sub-line indicator (5495) and line item identifier (1082).

Sub-line indicator code (5495): This data element is a coded data element with just one code value '1', which must be used to indicate the fact that sub-lines are in use.

Line item identifier (1082): This data element is used to identify the line item number (DE 1082, first occurrence) of the higher level product, to which the current sub-line is linked.

4.10.1. Examples of the use of sub-lines

Use of PRICAT to establish a product hierarchy between Consumer, Traded, and Despatch Units

The following is an example of a Price/Sales Catalogue message providing the addition of a new despatch unit, traded unit, and consumer unit to a trading partners file. The relationship or hierarchy between the different product levels is detailed through the use of sub-lines.

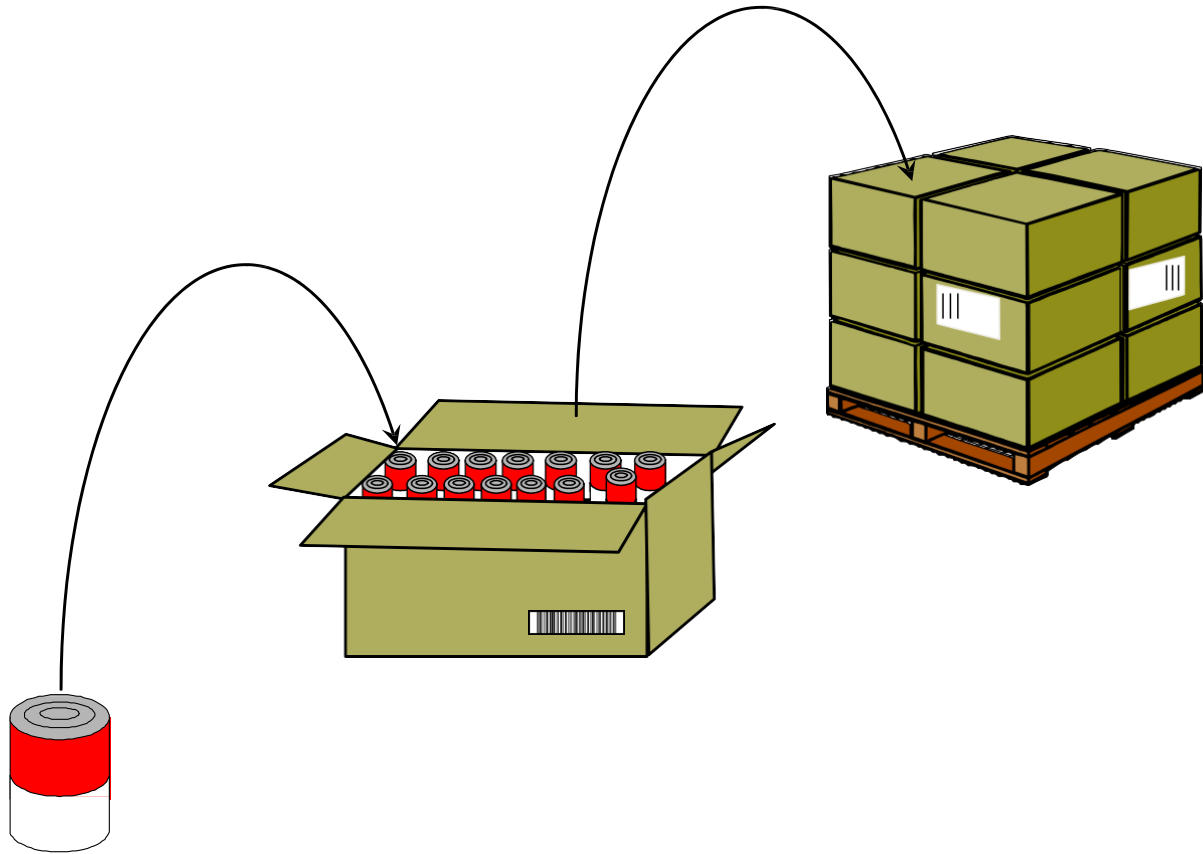

Can

GTIN: 5410738377131

Case

GTIN: 5410738377117

14 units of 5410738377131

Pallet

GTIN: 5410738251028

12 units of 5410738377117

Please note that only the segments relevant to the relationship of main lines and sub-lines are detailed here.

The first occurrence of LIN, with line number 1, is used to describe the consumer unit identified by the item number 5410738377131, being the code for a can of Healthiest Tomato Soup. No sub-lines are used since there is no reference to a smaller unit.

The second occurrence of LIN, with line number 2, is used to describe a traded unit identified by the item number 5410738377117, being the code for a case of Tomato Soup. There are 14 units contained at the next lowest level (i.e., consumer units) in the traded unit.

The third occurrence of LIN, with line number 3, is used to indicate that the consumer unit previously identified by the item number 5410738377131 is a sub-line of the traded unit identified by the article number 5410738377117.

The fourth occurrence of LIN, with line number 4, is used to describe the despatch unit identified by the item number 5410738251028, being the code for a pallet of Tomato Soup. There are 12 units contained at the next lowest level (i.e., traded units) in the despatch unit.

The fifth occurrence of LIN, with line number 5, is used to indicate that the traded unit previously identified by the item number 5410738377117 is a sub-line of the despatch unit identified by the article number 5410738251028.

UNH+ME000001+PRICAT:D:01B:UN:EAN008'
 BGM+9+PC32458+2'

 LIN+1+1+5410738377131:SRV' . LIN 1, consumer unit identified by GTIN
 . 5410738377131
 IMD+C++CU::9'
 IMD+F++:::TOMATO SOUP:CAN'

 PAC+++CX'
 LIN+2+1+5410738377117:SRV' . LIN 2, traded unit identified by GTIN
 . 5410738377117
 IMD+C++TU::9'
 IMD+F++:::TOMATO SOUP:CASE'
 QTY+17E:14' . The traded unit contains 14 units of the next lower
 level unit, i.e. consumer units

 PAC+++CS'
 LIN+3+1+5410738377131:SRV+1:2' . LIN 3, sub-line of LIN 2, contains consumer unit
 . 5410738377131
 QTY+45E:14' . There are 14 consumer units in the current packaging
 hierarchy, i.e., traded unit
 LIN+4+1+5410738251028:SRV' . LIN 4, despatch unit identified by GTIN
 . 5410738251028
 IMD+C++DU::9'
 IMD+F++:::TOMATO SOUP:PALLET'
 QTY+17E:12' . The despatch unit contains 12 units of the next lower
 level unit, i.e. traded units

 PAC+++201::9'
 LIN+5+1+5410738377117:SRV+1:4' . LIN 5, sub-line of LIN 4, contains traded unit
 . 5410738377117
 QTY+45E:12' . There are 12 traded units in the current packaging
 hierarchy, i.e., despatch unit

 UNT+.....

4.10.2. Sub-line amendment

Amendment of products which are used as sub-lines is handled in two ways:

- Amendment of non-identifying information (description, prices, etc.) is carried out by means of sending the LIN-PIA segments for the main line.
- Amendment of identifying and/or relational information (article number, quantity contained) is carried out by means of sending the LIN-PIA segments for both the main line and the related sub-line.

Sub-lines may be used to establish the relationship within a product hierarchy, i.e., consumer unit to despatch unit. The same general rules apply when identifying a product hierarchy as for the identification of a mixed range or assortment product, i.e., all levels of the product must first be identified in their own right as main lines before identifying the relationship between the levels.

4.10.3. Sub-line deletion

Sub-line deletion may exist in one of the following three forms:

- **Case 1:** The deletion of a product which exists in its own right and which is also used as a sub-line of other products.
- **Case 2:** The deletion of a product which contains sub-lines. The constituent products continue to exist in their own right.
- **Case 3:** The deletion of a sub-line from a product configuration.

Case 1: When deleting a product which exists in its own right (e.g., anti-septic ointment identified by GTIN99) but which is also used in a sub-line configuration (e.g., first aid kit identified as GTIN1) the following steps apply:

- Because the deletion of an element of the configuration results in what is essentially a new configuration, the main-line which identifies the configuration (i.e., GTIN1) must be marked for deletion by indicating the code value 2 in data element 1229. When this has been done the configuration (minus GTIN99) must be re-specified using a new GTIN (GTIN2). This process must apply to **ALL** configurations which include, as a sub-line, the product being deleted.
- The product (GTIN99) must be deleted as a main line by indicating in data element 1229 the code value 2.

Example:

LIN+1+2+ GTIN1:SRV' Identification of main line article which contains sub-line to be deleted.
This product is marked for deletion.

LIN+2+2+ GTIN99:SRV' Identification of product as a main line which is marked for deletion.

LIN+3+1+ GTIN2:SRV' Identification of configuration as new product (excluding deleted sub-line).

LIN+4+1+ GTIN96:SRV+1:3' Identification of component as sub-line of new product.

LIN+5+1+ GTIN97:SRV+1:3' Identification of component as sub-line of new product.

LIN+6+1+ GTIN98:SRV+1:3' Identification of component as sub-line of new product.

Case 2: When deleting a product which contains sub-lines (e.g., first aid kit identified by article number GTIN1) the following steps apply:

- The product must be deleted as a main line by indicating the code value 2 in data element 1229. This deletion will automatically delete any sub-line relationships which exist for this main line.

Example:

LIN+1+2+ GTIN1:SRV' Identification of main line article to be deleted which contains sub-lines.

Case 3: When deleting a sub-line (e.g., anti-septic ointment identified by GTIN99) from a product configuration (e.g., first aid kit identified as GTIN1) which contains other sub-lines (the configuration, which will continue to exist after the deletion of this one sub-line, and the main-line product for the sub-line, which will also continue to exist) the following steps apply:

- Because the deletion of an element of the configuration results in what is essentially a new configuration, the main-line which identifies the configuration (i.e., GTIN1) must be marked for deletion by indicating the code value 2 in data element 1229. When this has been done the configuration (minus GTIN deleted sub-line) must be re-specified using a new GTIN (GTIN2).

Example:

LIN+1+2+ GTIN1:SRV' Identification of main line article which contains sub-line to be deleted. This product is marked for deletion.

LIN+2+1+ GTIN2:SRV' Identification of configuration as new product (excluding deleted sub-line).

LIN+3+1+ GTIN96:SRV+1:2' Identification of component as sub-line of new product

LIN+4+1+ GTIN97:SRV+1:2' Identification of component as sub-line of new product.

LIN+5+1+ GTIN98:SRV+1:2' Identification of component as sub-line of new product.

5.11. Hierarchies in PRICAT/PRODAT

A hierarchy in the EANCOM® Price/Sales catalogue (PRICAT) and Product Data (PRODAT) message is a facility which allows products to be linked together in a parent-child relationship. Unlike sub-lines (relationship referenced by line numbers), hierarchies provide an explicit indication as to whether an article is a parent or a child in a relationship.

While the use of the sub-line technology is not allowed within the PRODAT message, the PRICAT message enables both possibilities. However, in PRICAT messages, hierarchy solution based on HYN segment is strongly recommended.

The hierarchy structure in PRICAT/PRODAT essentially takes the same format as that detailed earlier for sub-lines, i.e. the tree structure. The minimum requirement of any hierarchy relationship in EANCOM® is that there must be at least one parent. However, having said that, a child product may also act as a parent to another child at the next level down in the hierarchy.

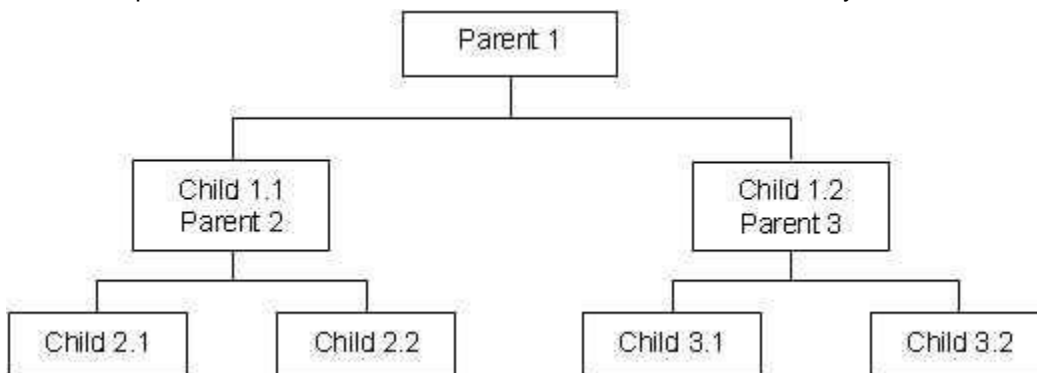

When using EANCOM® to provide product configurations using the hierarchy facility in PRICAT/PRODAT, it is recommended that all constituent members of the hierarchy parts of the

configuration first be communicated as main lines in the PRICAT/PRODAT message. When this has been done, the hierarchy relationships can be specified.

A simple example which details the structure presented above follows hereunder:

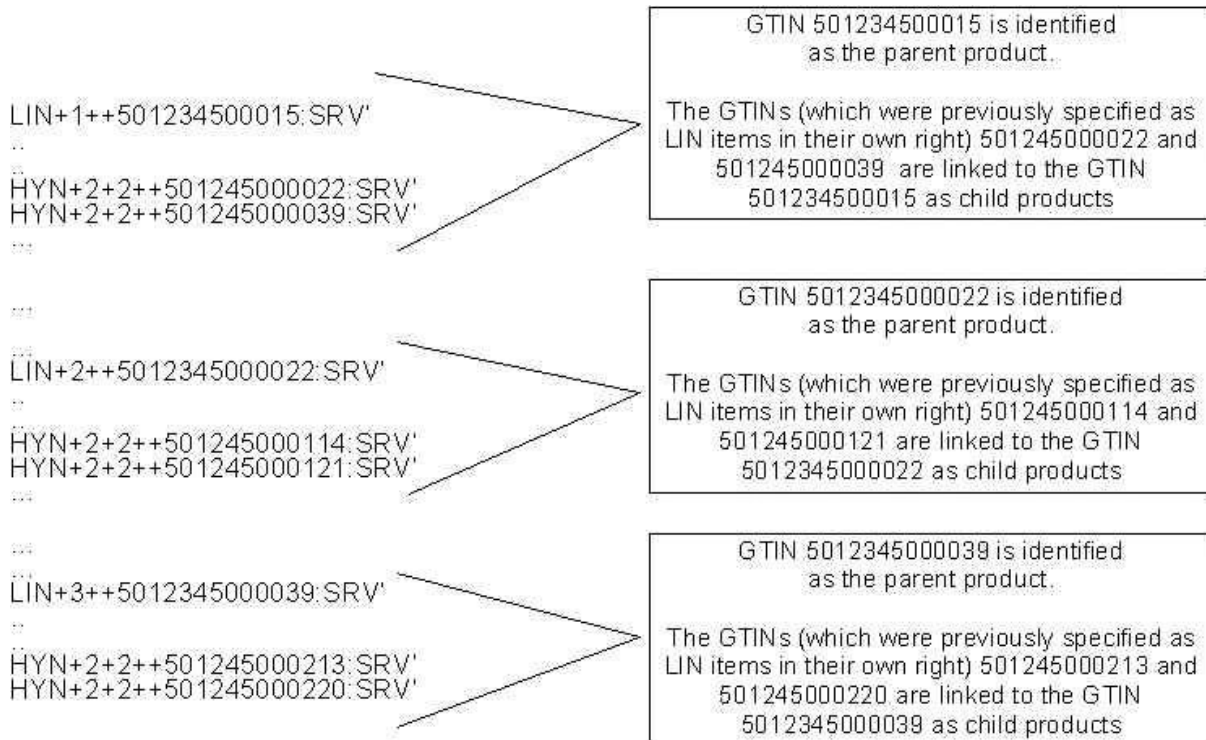

5.12. Referencing in EANCOM® (RFF)

The effective use of EANCOM® depends on the use of referencing to reduce the quantity of data required to be transmitted in any message. Referencing provides the opportunity to link messages with multiple pieces of external information which may or may not have been transmitted using EDI. A comparison with manual systems would be a situation where, for example in an invoice, references are provided to the order and the delivery docket but paper copies of both of these documents are normally not provided with the paper invoice. EDI works on a similar basis using the RFF segment which allows references to other documents to be transmitted without a need to transmit the actual documents.

Within EANCOM® messages several references exist which can be used to link the information exchanged between the trading partners with the physical movement of goods or data.

Of primary importance in a trade transaction is the order number which is usually assigned by the buyer and which provides a unique reference to the transaction. In EANCOM® messages the order number is quoted in several messages following the actual EANCOM® order (e.g., the order response, the despatch advice, the receiving advice, the invoice, the remittance advice) as a means of linking information from different messages in the EANCOM® message flow. Together with the order number, line numbers are used to uniquely identify an order line for referencing purposes.

It is important to note that it is not recommended to use GTINs for unique message line referencing within EANCOM® messages. This is because it is possible for GTIN's to be repeated within the same message, (e.g., the same article ordered many times for different delivery points).

The only method available within EANCOM® to uniquely identify a previous EANCOM® message is to put the message number (generated in DE 1004 of the BGM segment of the original message) in data element 1154 of the RFF segment. Should it be required to identify an individual line (identified by Line

Item Number data element 1082 in the LIN segment of the original message), then this should be put in data element 1156 alongside the message number in data element 1154 of the RFF segment.

A simple example follows:

A buyer sends 3 orders requesting the supply of the product identified by the GTIN 5012345000220 to the locations as detailed below:

Order Number (DE 1004 BGM segment)	Order Line Number (DE 1082 LIN segment)	Product GTIN	Delivery Location GLN
181	1	5012345000220	5012345000015
201	1	5012345000220	5012345000121
201	2	5012345000220	5012345000015
190	1	5012345000220	5012345000213

To access each of the lines above, perhaps in a following message like a despatch advice, the following RFF segments would be used.

```
RFF+ON:181:1'      . Order number 181, line number 1
RFF+ON:201:1'      . Order number 201, line number 1
RFF+ON:201:2'      . Order number 201, line number 2
RFF+ON:190:1'      . Order number 190, line number 1
```

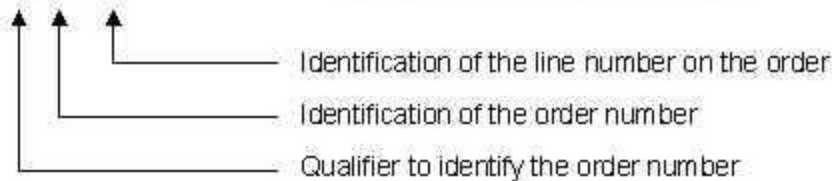

5.13. Package Marking in EANCOM®

Within EANCOM® it is possible to specify marks and numbers which are to be, or have been, marked on the physical packaging of a product or a consignment. This functionality is provided in the PCI and GIN segments, which normally are nested below a PAC segment. The following guidelines should be observed when deciding which segment to use, and its data content, for package marking;

Markings for human readable purposes:

It is recommended that markings which are to be read by humans are provided as free text in the PCI segment using as many repeats of data element 7102 as are required.

Qualification of the type of marking specified (e.g., mark expiry date) in data element 7102 is provided in data element 4233.

While such markings may also have been specified as formatted information in another segment in the LIN group, these formats are not considered to be human readable, (e.g., in a DTM segment a date would have the following format '20021001', while a translation into a human readable format would be as follows '1 October 2002').

Markings for identification purposes:

It is recommended that markings which are to be used for identification, automatic data capture, or tracking purposes (e.g., a batch number or a serial shipping container code) be specified in the GIN segment using data element 7402. Qualification of the type of identification code used is provided in data element 7405.

If multiple, non-consecutive identification numbers are provided, then each of them is placed in the first DE 7402 of C208. Example for SSCCs 354123450000000014, 354123450000000106 and 3541234500000000190:

GIN+BJ+354123450000000014+354123450000000106+354123450000000190'

If a range of consecutive identification numbers is provided, then the first number in that range is placed alone in the first DE 7402 of C208, and the last number in that range is placed alone in the second DE 7402 for that particular C208. Example for SSCCs 354123450000000014 through 354123450000000030, inclusive:

GIN+BJ+354123450000000014:354123450000000030'

5.14. Communicating GS1 trade item numbers in EANCOM®

When communicating GS1 trade item numbers in EANCOM®, the leading zeros in the number cannot be transmitted, since the format of the DE 7140 is numeric: n..14. EDIFACT syntax does not allow transmitting leading zeroes for numeric data.

Given that there are 4 types of GS1 trade item numbers (i.e., different lengths) the following rules apply:

Number Type	Global Trade Item Number (GTIN)	DE 7143
ITF-14	N1 N2 N3 N4 N5 N6 N7 N8 N9 N10 N11 N12 N13 N14	SRV
GTIN-13	N1 N2 N3 N4 N5 N6 N7 N8 N9 N10 N11 N12 N13	SRV
UPC-A	N1 N2 N3 N4 N5 N6 N7 N8 N9 N10 N11 N12	SRV
GTIN-8	N1 N2 N3 N4 N5 N6 N7 N8	SRV



Note: Due to differences in syntax, the format of GTIN in both GS1 eCom standards: EANCOM® and GS1 XML are different.

- In GS1 XML the format is defined as exactly 14 digits, which means that any GTIN that is originally shorter than 14 digits needs to be filled up to 14 characters by adding the leading zeroes
- In GS1 EANCOM® the format is numeric, which means that any leading zeroes must be removed

However, all these formats still convey the same GTIN identifier. GS1 recommends that GTIN should be stored in a 14-digit format. It can be transmitted in eCom messages or encoded in bar codes in a format that suites the syntax rules or bar code symbology.

5.15. GS1 Application Identifiers in EANCOM®

The GS1 Application Identifiers (AIs) consist of:

- a standard format and definition for each relevant data element
- application identifiers used as a prefix to the data elements represented in bar coded form
- a bar code symbology specifically dedicated to encoding AIs: GS1-128

Application Identifiers have been defined for international and inter-sectorial use. They allow simple and generic data elements to be encoded in bar coded form. This in turn allows fully automated data capture and processing within computer systems.

GS1 standards are used in five major areas of application that are listed below. A table of the most important Application Identifiers and a mapping for each to the segment, data element, and if relevant, code value in EANCOM® is given for each area.

Please note that the tables are intended to allow the identification of the primary information mapping requirements between the GS1 Application Identifiers and EANCOM®. Additional information on GS1 Application Identifiers may be found in the GS1 General Specifications.

4.15.1. Application Identifiers related to trade items

Trade items are goods and services upon which there is a need to retrieve fixed information at any point in the supply chain. A trade unit is typically a unit which is priced, ordered or invoiced.

AI	Data Content	EANCOM® Segment	Data Element	Code Value / Code Name
Identification of a fixed/variable measure trade item				
01	GTIN	LIN PIA	7143 7143	SRV = GS1 Global Trade Item Number
02	GTIN of Contained Trade Items	LIN	7143	SRV = GS1 Global Trade Item Number
Supplementary information				
10	Batch or Lot number	PIA GIN	7143 7405	NB = Batch number BX = Batch number
11	Production date	DTM	2005	94 = Production / manufacture date
13	Packaging date	DTM	2005	365 = Packaging date
15	Minimum durability date	DTM	2005	360 = Sell by date 361 = Best before date
17	Maximum durability date	DTM	2005	36 = Expiry date
20	Variant number	PIA	7143	PV = Promotional Variant number
21	Serial number	PIA GIN	7143 7405	SN = Serial number BN = Serial number
240	Additional product identification assigned by the manufacturer	PIA	7143	SA = Supplier's article number
241	Customer part number	PIA	7143	IN = Buyer's item number
30	Variable count	QTY	6411	EA = Each (Implied unit of measure)
310(1)	Trade measure Net weight, kilograms	MEA	6313 6411	AAA = Unit net weight, KGM = Kilograms
311(1)	Trade measure Length or 1st dimension, metres	MEA	6313 6411	LN = Length MTR = Metre
312(1)	Trade measure Width, diameter or 2nd dimension, metres	MEA	6313 6411	WD = Width, DI = Diameter MTR = Metre
313(1)	Trade measure Depth, thickness, height, or 3rd dimension, metres	MEA	6313 6411	DP = Depth, TH = Thickness, HT = Height, MTR = Metre

314(1)	Trade measure Area, square metres	MEA	6313 6411	X12 = Area (GS1 code) MTK = Square metre
315(1)	Trade measure Net volume, litres	MEA	6313 6411	AAX = Net volume LTR = Litre
316(1)	Trade measure Net volume, cubic metres	MEA	6313 6411	AAX = Net volume MTQ = Cubic metre
422	Country of origin of the product	ALI LOC	3239 3227	Various 27 = Country of origin

NOTE: (1) GS1 Application Identifiers for measures have four digits. The fourth digit is a decimal point indicator; please refer to GS1 General Specifications for more details.

Only GS1 Application Identifiers for "metric" measures are shown in this table. For other units of measure please refer to GS1 General Specifications.

4.15.2. Application Identifiers related to logistic units

Logistic units are physical units established for transport and storage of goods of any kind that need to be tracked and traced individually in a supply chain.

AI	Data Content	EANCOM® Segment	Data Element	Code Value / Code Name
Identification of a logistic unit				
00	Serial Shipping Container Code	GIN	7405	BJ = Serial shipping container code <i>Note: The EDIFACT specification contains another code value qualifying SSCC number: AW; GS1 recommends use of BJ to ensure consistency.</i>
02	GTIN of Contained Trade Items	LIN	7143	SRV = GS1 Global Trade Item Number
Supplementary information				
37	Serial Count of trade items contained in a logistic unit (used in conjunction with AI 02)	QTY	6063	Various
330(1)	Logistics measure Logistic weight, kilograms	MEA	6313 6411	AAB = Unit gross weight KGM = Kilograms
331(1)	Logistics measure Length or 1st dimension, metres	MEA	6313 6411	LN = Length MTR = Metre
332(1)	Logistics measure Width, diameter or 2nd dimension, metres	MEA	6313 6411	WD = Width, DI = Diameter, MTR = Metre
333(1)	Logistics measure Depth, thickness, height, or 3rd dimension, metres	MEA	6313 6411	DP = Depth, TH = Thickness, HT = Height MTR = Metre

334(1)	Logistics measure Area, square metres	MEA	6313 6411	X12 = Area (GS1 code) MTK = Square metre
335(1)	Logistics measure Logistic volume, litres	MEA	6313 6411	AAW = Gross volume LTR = Litre
336(1)	Logistics measure Logistic volume, cubic metres	MEA	6313 6411	AAW = Gross volume MTQ = Cubic metre
400	Customer's purchase order number	RFF	1153	ON = Order number (buyer)
401	Consignment number	RFF	1153	CU = Consignor's reference number

*NOTE: (1) GS1 Application Identifiers for measures have four digits. The fourth digit is a decimal point indicator; please refer to GS1 General Specifications for more details.
Only GS1 Application Identifiers for "metric" measures are shown in this table. For other units of measure please refer to GS1 General Specifications.*

4.15.3. Application Identifiers related to locations

A location is anything which can be assigned an address. Some examples of this would include companies, departments, rooms, factories, shelves, delivery points, EDI network addresses etc.

AI	Data Content	EANCOM® Segment	Data Element	Code Value / Code Name
410	Ship to - Deliver to GLN	NAD LOC	3035 3227	DP = Delivery party 7 = Place of delivery
411	Bill to - Invoice to GLN	NAD	3035	IV = Invoicee
412	Purchase from GLN	NAD	3035	SU = Supplier
413	Ship for - Deliver for - Forward to GLN	NAD LOC	3035 3227	UC = Ultimate consignee 7 = Place of delivery
414	Identification of a physical location GLN	NAD LOC	3035 3227	Various Various
420	Ship to – Deliver to postal code	NAD	3251	Various
421	Ship to – Deliver to postal code with ISO country code	NAD	3251 3027	Various Various

4.15.4. Application Identifiers related to assets

An asset is broadly defined as anything that is owned and not traded. This definition includes individual assets of a company as well as returnable assets, which may be used to transport products between organisations. Examples of assets include beer kegs, gas cylinders, chemical containers, pallets and crates.

EANCOM® Segment	Data Element	Code Value / Code Name
PCI GIN	4233 7405	47=Marked with GS1 Global Returnable Asset Identifier (GRAI) DA = GS1 Global Returnable Asset Identifier, without serial number DB = GS1 Global Returnable Asset Identifier, with serial number
PCI GIN	4233 7405	34 = Marked GS1 Global Individual Asset Identifier CU = GS1 Global Individual Asset Identifier

4.15.5. Other Applications

This area comprises specific application guidelines dealing with the numbering and symbol marking of items not covered by the areas above. The applications described are generally very specific and require special consideration (e.g., coupons, refund receipts, service relationships, etc.), but are still aimed at being used in an open environment.

6. APPENDIX 1: UN/EDIFACT

6.1. Definition of UN/EDIFACT

United Nations Directories for Electronic Data Interchange for Administration, Commerce and Transport. They comprise a set of internationally agreed standards, directories and guidelines for the electronic interchange of structured data, particular as related to trade in goods and services, between independent, computerised information systems.

Recommended within the framework of the United Nations, the rules are approved and published by the UN/CEFACT (United Nations Centre for Trade Facilitation and Electronic business) in the United Nations Trade Data Interchange Directory (UNTDID) and are maintained under agreed procedures. UNTDID includes:

- EDIFACT – Application level syntax rules (Syntax version: 4);
- Message design guidelines;
- Syntax implementation guidelines;
- EDIFACT Data Elements Directory, EDED (a subset of UNTDED);
- EDIFACT Code list, EDCL;
- EDIFACT Composite data elements Directory, EDCD;
- EDIFACT standard Segments Directory, EDSD;
- EDIFACT United Nations Standard Messages Directory, EDMD;
- Uniform Rules of Conduct for the Interchange of Trade Data by Tele-transmission (UNCID);
- Explanatory material, as appropriate.

Actual information is available at www.unece.org/trade/untdid.

6.2. EDIFACT Syntax version 4 overview

This section is a summary of the document: "EDIFACT - Application level syntax rules (Syntax version 4)". Actual information is available at www.unece.org/cefact.

The UN/EDIFACT syntax rules set the rules for structuring data into segments, segments into messages, and messages into an interchange.

5.2.1. Interchange Structure

An interchange may consist of the following segments:

	UNA		
	UNB	Interchange Header	Mandatory
	UNG	Functional Group Header	Conditional
	UNH	Message Header	Mandatory
		USER DATA SEGMENTS	
	UNT	Message Trailer	Mandatory
	UNE	Functional Group Trailer	Conditional
	UNZ	Interchange trailer	Mandatory

Segments starting with "UN" are called service segments. They constitute the envelope or the "packaging" of the UN/EDIFACT messages.

User data segments contain the information itself, in a format specific to each message type.

5.2.2. Message Structure

Each data segment has a specific place within the sequence of segments in the message. They may occur in any of the following three sections of the message:

- a. **Heading section** - A segment occurring in this section relates to the entire message.
- b. **Detail section** - A segment occurring in this section relates to the detail information only.
- c. **Summary section** - Only segments containing totals or control information may occur in the summary section, e.g. invoice total amount, number of lines in a purchase order, etc.

The sequence of the three message sections can be represented by the following simple example:

```

. Message header
.
UNH.....
BGM.....
.....
.....
.
. Message detail
.
LIN.....
QTY.....
.....
.....
.
. Message trailer
.
CNT.....
UNT.....
    
```

The same segment type may occur in more than one of the message sections, for example in the header and in the detail section, and/or more than once in the same section.

Some segments may be repeated a certain number of times at their specific location in the message. The status, Mandatory or Conditional, and the maximum number of repetitions of segment types are indicated in the message structure.

Within a message, specific groups of functionally related segments may be repeated; these groups are referred to as "segment groups". The maximum number of repetitions of a particular segment group at a specific location is included in the message definition.

A segment group may be nested within other segment groups, provided that the inner segment group terminates before any outer segment group terminates.

5.2.3. Segment structure

A segment consists of:

- A segment tag: identifies the segment type
- Data element separators
- Simple and/or composite data elements
- A segment terminator

Data elements can be defined as having a fixed or variable length.

A composite data element contains two or more component data elements.

A component data element is a simple data element used in a composite data element.

Example of a composite data element:

DTM+2:20121210:102'

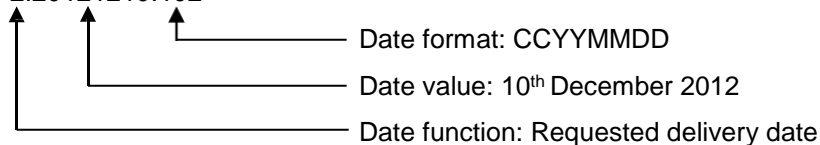

The date qualifiers: function and value are the component data elements.

A data element can be qualified by another data element, the value of which is expressed as a code that gives specific meaning to the data. The data value of a qualifier is a code taken from an agreed set of code values.

Multiple occurrences of stand-alone simple or composite data elements are permitted.

5.2.4. Service characters

In EANCOM®, four characters, extracted from character set level A, have a special meaning and act as the default service characters for EANCOM®:

Apostrophe ' = segment terminator

Plus sign + = segment tag and data element separator

Colon : = Component data element separator (separating simple data elements within a composite data element)

Question mark ? = Release character which, when immediately preceding one of the service characters, restores that character's normal meaning. For example, 10?+10=20 means 10+10=20. Question mark is represented by ??

Asterisk * = repetition separator

Within EANCOM® 2002 syntax 3 the use of UNA is conditional.

Should trading partners agree to use any of the character sets from B to F (inclusive) and the default separators from UNOA, then the UNA segment must be provided to explicitly state the default separator values.

Example of an UN/EDIFACT segment:

DTM+137:20020101:102'

- DTM = Tag of the "Date/Time/Period" segment;
- + = Data element separator;
- 137 = Qualifier to indicate the date is the Document/Message Date/Time;
- : = Component data element separator (separating the date qualifier and the date);
- 2002010 = Date;
- : = Component data element separator (separating the date and the date format qualifier);
- 102 = Qualifier to indicate the format of the date (CCYYMMDD);
- ' = Segment terminator.

5.2.5. Compression of data

In data elements for which the Trade Data Elements Directory specifies variable length and no other restrictions, non-significant character positions, (i.e. leading zeroes and trailing spaces) should be suppressed.

TAG = segment tag; DE = data element; CE = component data element.

- **Exclusion of segments.** Conditional segments containing no data should be omitted (including their segment tags).
- **Exclusion of data elements by omission.** Data elements are identified by their sequential position within the segments as stated in the Segment Directory. If a conditional data element is omitted and followed by another data element, its position should be indicated by retention of its data element separator.

Example: TAG+DE+DE+DE+CE:CE:CE' complete segment including all data elements

TAG+DE++DE+CE:CE:CE'
 ↑ _____ one DE has been omitted

- **Exclusion of data elements by truncation.** If one or more conditional data elements at the end of a segment are omitted, the segment may be truncated by the segment terminator.

Example: TAG+DE+DE+DE+DE' Original including all data elements

TAG+DE+DE'
 ↑ _____ truncation

- **Exclusion of component data elements by omission.** If a conditional CE is omitted and followed by another CE, its given position must be represented by its CE separator.

Example: TAG+DE++DE+CE:CE:CE' Original including all CE's

TAG+DE++DE+CE::CE'
 ↑ _____ one CE has been omitted

- **Exclusion of component data elements by truncation.** One or more conditional CE's at the end of a composite DE may be excluded by truncation by the DE separator or, if at the end of a segment, by the segment terminator.

Example: TAG+DE++DE+CE:CE:CE' Original including last CE
 TAG+DE++DE+CE :CE'
 ↑ truncation

- **Exclusion of component data elements by omission.** The position of an occurrence of a repeating data element may be significant in some cases (e.g., transfer array data). In such a case, if an occurrence of a repeating data element is omitted and is followed by another occurrence of the same repeating data element, its position shall be indicated by retention of the repetition separator which would normally follow it.

Example: TAG+DE+DE*DE*DE*DE+DE' Original including all DE's
 TAG+DE+DE*DE**DE+DE'
 * one DE has been omitted

- **Exclusion of component data elements by truncation.** One or more conditional CE's at the end of a composite DE may be excluded by truncation by the DE separator or, if at the end of a segment, by the segment terminator.

Example: TAG+DE1+DE2*DE2*DE2 +DE3*DE3 Original including all DEs
 TAG+DE1+DE2+DE3'
 ↑ Only one occurrence of DE2 and DE3

5.2.6. Representation of numeric values

- **Decimal sign.** The representation for decimal sign is the point on the line (.). The decimal sign should not be counted as a character when computing the maximum field length of a data element. When a decimal sign is transmitted, there should be at least one digit before and after the decimal sign.
- To assist in-house file designers and data interchange partners, the following lengths may be used as a guideline:

Numeric Class	Format	Integer Digit	Decimal Digit
Amounts	n..18	12	6
Control Values	n..18	14	4
Cubes	n..9	5	4
Currency Rates	n..12	6	6
Other Range Value	n..18	15	3
Percentages	n..10	6	4
Percentage Range Value	n..18	14	4
Quantities	n..15	12	3
Rate per Unit	n..15	12	3
Tax Rates	n..17	13	4
Unit Prices	n..15	11	4
Unit Price Basis	n..9	6	3
Weights	n..18	15	3

- **Triad separator.** Triad separators should not be used in the interchange. (Allowed: 2500000; Not allowed: 2,500,000 or 2.500.000 or 2 500 000).

- Sign.** Numeric data element values should be regarded as positive. Although a deduction is conceptually negative, it should be represented by a positive value, (e.g. in a credit note all values are positive, and the application software uses the message name coded (DE 1001) to convert all values into negative). In addition, some data elements and code combinations will lead to implied negative values, (e.g. data element 5463 with code value 'A, Allowance' in an ALC segment in an invoice).

If a value is to be represented as negative, in transmission it should be immediately preceded by a minus sign (e.g., -112). The minus sign shall not be counted as a character when computing the maximum field length of a data element.

Example 1 (INVOIC)

...
 BGM+381+CN52+9' INVOIC message is used as a credit note
 ...
 LIN+1+++4000862141404:SRV' Line item 1 identified by GTIN 4000862141404.
 ...
 QTY+61:2' Return quantity is 2.
 MOA+203:200' Line item amount is 200.
 PRI+AAA:100:CA' Net price from the catalogue is 100.

As DE 1001 in the header contains code value 381, the numeric values in MOA and QTY should be interpreted as negative by the in-house application.

Example 2 (INVOIC)

...
 BGM+380+IN42652+9' Commercial invoice number IN42652.
 ...
 LIN+1+++4000862141404:SRV' Line item 1 identified by GTIN 4000862141404.
 ...
 MOA+203:200' Line item amount is 200.
 ...
 ALC+A' Allowances
 MOA+204:12' The numeric value is 12.
 ...

As DE 5463 in the ALC segment contains code value A, the numeric values in MOA below should be interpreted as negative by the in-house application.

It is recommended to create one message for the invoice and one message for the credit note. As this is not always possible (e.g., an invoice for drinks with a negative deposit balance at detail level) the minus sign can be used in DE 6060 of the QTY segment and in DE 5004 of the MOA segment.

This rule is applicable for debit lines in credit notes and for credit lines in invoices/debit notes.

If allowances or charges are calculated backwards (credit note for a previously sent invoice) the code value in ALC DE 5463 is not changed.

5.2.7. Character set and syntax identifiers

Supported character sets

In syntax version 4 character sets level A, B, C, D, E, F, G, H, I, J, K, X and Y are supported. Also supported are the code extension techniques covered by ISO 2022 (with certain restrictions on its use within an interchange), and the partial use of the techniques covered by ISO/IEC 10646-1.

Within EANCOM® the use of character set level A is recommended. Any user, wishing to use a character set level other than A, should first obtain agreement from the intended trading partner in order to ensure correct processing by the receiving application.

Character set level A

Character set level A (ISO 646 7-bit single byte code, with the exception of lower case letters and certain graphic character allocations) contains the following characters:

Letters, upper case A to Z

Numerals 0 to 9

Space character

Full stop .

Comma ,

Hyphen/minus sign -

Opening parentheses (

Closing parentheses)

Oblique stroke (slash) /

Equal sign =

Exclamation mark !

Quotation mark “

Percentage sign %

Ampersand &

Asterisk *

Semi-colon ;

Less-than sign <

Greater-than sign >

Character set level B

Character set level B (ISO 646 7-bit single byte code, with the exception of certain graphic character allocations) contains the same characters as character set level A plus lower case letters ‘a’ to ‘z’.

Character sets level C to F

Character sets level C to F (ISO 8859 - 1,2,5,7 8-bit single byte coded graphic character sets) cover the Latin 1 - 2, Cyrillic and Greek alphabets.

It is important to note that EANCOM® users often need, in addition to the recommended character set level A, the following sub-set of supplementary characters taken from ISO 8859 - 1:

Number sign #

Commercial at @

Left square bracket [

Reverse solidus \

Right square bracket]

Circumflex accent ^

Grave accent `

Left curly bracket {
 Vertical line |
 Right curly bracket }

Syntax identifier, ISO standard and supported languages

The following table contains the code values for the syntax identifier and explains which languages are catered for in which part of ISO-8859.

Note that the last character of the syntax identifier (data element 0001) identifies the character set level used.

Syntax identifier	ISO standard	Languages
UNOA	646	
UNOB	646	
UNOC	8859 - 1	Danish, Dutch, English, Faeroese, Finnish, French, German, Icelandic, Irish, Italian, Norwegian, Portuguese, Spanish, Swedish
UNOD	8859 - 2	Albanian, Czech, English, Hungarian, Polish, Romanian, Serbo-Croatian, Slovak, Slovene
UNOE	8859 - 5	Bulgarian, Byelorussian, English, Macedonian, Russian, Serbo-Croatian, Ukrainian
UNOF	8859 - 7	Greek

6.3. Directory status, version and release

All EANCOM® 2002 messages are based on the UN/EDIFACT directory D.01B, which was released by UN/CEFACT in 2001. All messages contained in this directory are approved as United Nations Standard Messages (UNSM).

6.4. EANCOM® message version

Each EANCOM® message carries its own subset version number, which allows the unambiguous identification of different versions of the same EANCOM® message. The EANCOM® subset version number is indicated in data element 0057 in the UNG and UNH segments. It is structured as follows:

EANnnn

where:

EAN = EANCOM is the name of the standard, GS1 is the agency controlling the subset.

nnn = Three-digit version number of the EANCOM® subset.

Subset version numbers for formally released EANCOM® messages start at the number '001' and are incremented by one for each subsequent version of the message.

6.5. Documentation conventions

5.5.1. Format and picture of data elements

The following conventions apply in the present documentation:

Character type:

a :alphabetic characters

n :numeric characters

an :alpha-numeric characters

Size:

Fixed : all positions must be used

Variable : positions may be used up to a specified maximum

Examples:

a3 :3 alphabetic characters, fixed length

n3 :3 numeric characters, fixed length

an3 :3 alpha-numeric characters, fixed length

a..3 :up to 3 alphabetic characters

n..3 :up to 3 numeric characters

an..3 :up to 3 alpha-numeric characters

5.5.2. Indicators

Segment layout

This section describes the layout of segments used in the EANCOM® messages. The original UN/EDIFACT segment layout is listed. The appropriate comments relevant to the EANCOM® subset are indicated.

The segments are presented in the sequence in which they appear in the message. The segment or segment group tag is followed by the (M)andatory / (C)onditional indicator, the maximum number of occurrences and the segment description.

Reading from left to right, in column one, the data element tags and descriptions are shown, followed by in the second column the UN/EDIFACT status (M or C), the field format, and the picture of the data elements. These first pieces of information constitute the original UN/EDIFACT segment layout.

Following the UN/EDIFACT information, EANCOM® specific information is provided in the third, fourth, and fifth columns. In the third column a status indicator for the use of (C)onditional UN/EDIFACT data elements (see description below), in the fourth column the restriction indicator, and in the fifth column notes and code values used for specific data elements in the message.

Status indicators

(M)andatory data elements or composites in UN/EDIFACT segments retain their status in EANCOM®.

Additionally, there are five types of status with a (C)onditional UN/EDIFACT status, whether for simple, component or composite data elements. They are listed below and can be identified when relevant by the abbreviations.

- **REQUIRED** **R** - Indicates that the entity is required and must be sent.
- **ADVISED** **A** - Indicates that the entity is advised or recommended.
- **DEPENDENT** **D** - Indicates that the entity must be sent in certain conditions, as defined by the relevant explanatory note.
- **OPTIONAL** **O** - Indicates that the entity is optional and may be sent at the discretion of the user.
- **NOT USED** **N** - Indicates that the entity is not used and should be omitted.

If a composite is flagged as N, NOT USED, all data elements within that composite will have blank status indicators assigned to them.

Restriction indicators

- **Restricted (*)** - a data element marked with an asterisk (*) in the fourth column of the segment details of a message indicates that the listed codes in column five are the only codes available for use with the data element at the same level as the asterisk, in the current segment, in the current message.
- **Open** - all data elements in which coded representation of data is possible, and in which a restricted set of code values is not indicated, are open. The available codes are listed in the Data Elements and Code Sets Directory (Part III of this manual). Code values may be given as examples or there may be a note on the format or type of code to be used.

Different colours are used for the code values in the HTML segment details: restricted codes are in red and open codes in blue.

6.6. Message structure charts and branching diagrams

Within every EANCOM® message two diagrams are presented which explain the structure and sequence of the message. These diagrams are known as the Message Structure Chart and the Message Branching Diagram.

The message structure chart is a sequential chart which presents the message in the sequence in which it must be formatted for transmission. Every message is structured and consists of three sections; a header, detail, and summary section. An example of a message structure chart follows:

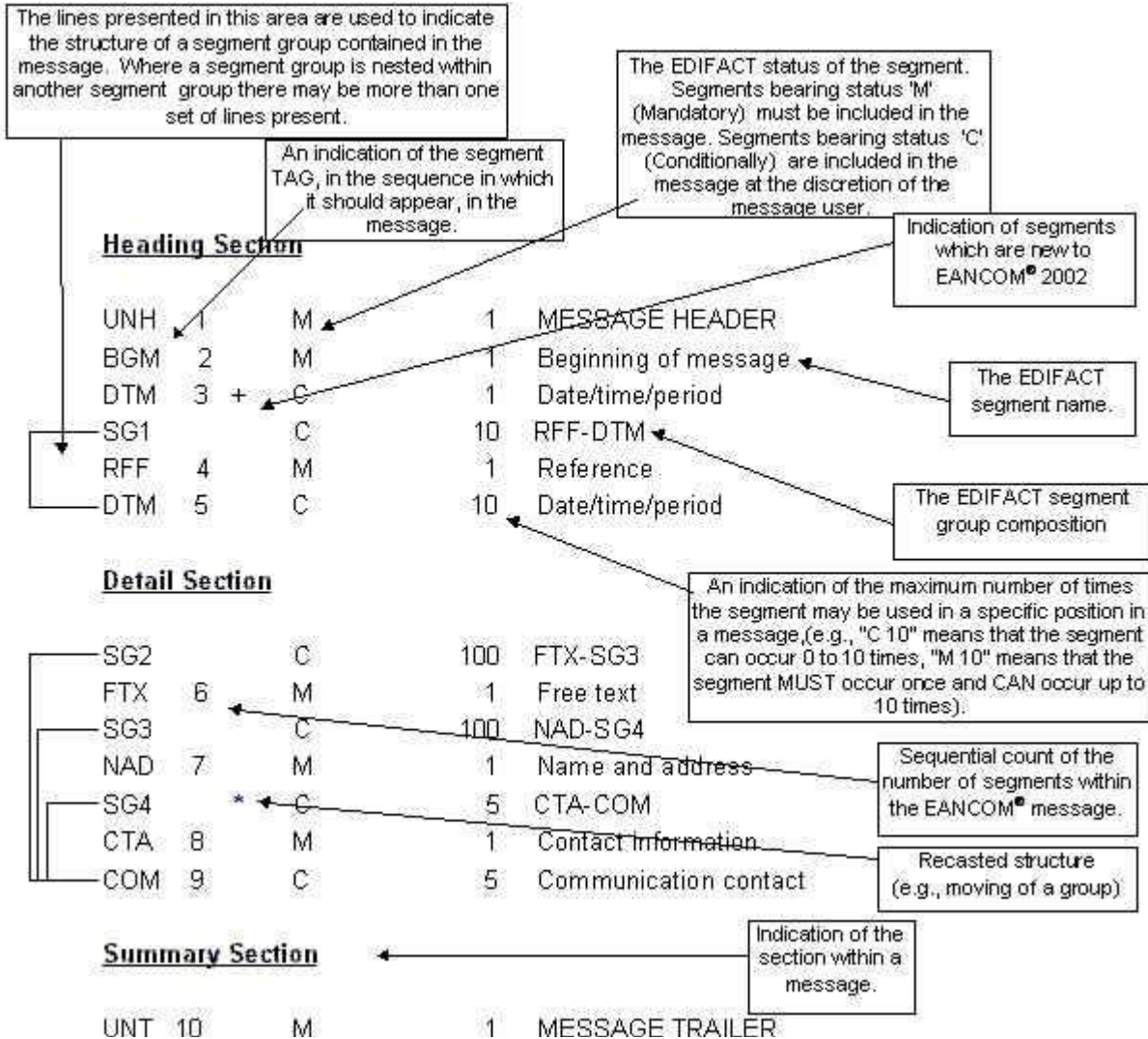

The structure chart should always be read from top down and left to right (please note that the message detailed is simply an example message and does not bear any relevance to real EANCOM® messages).

A message branching diagram is a pictorial representation (in flow chart style) which presents the logical sequence and relationships contained within a message.

Branching diagrams should be read, starting at the UNH segment, from left to right and top to bottom. The lines contained within a branching diagram should be considered as guides that must be followed in order to progress through the message.

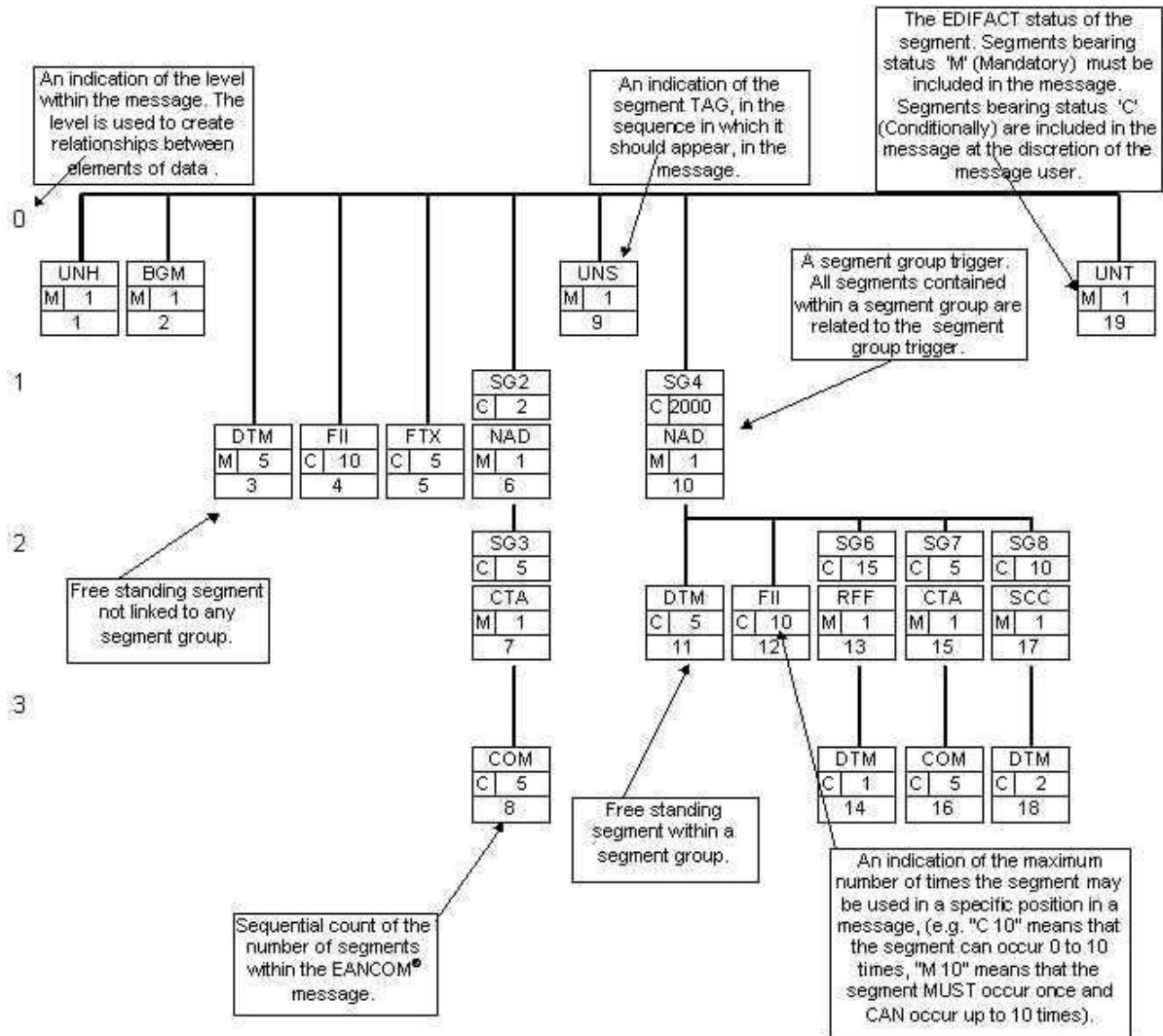

6.7. Interchange structure and service segments

The interchange structure in an UN/EDIFACT transmission is organised through several grouping levels. The service segments are the envelope of the groups.

The first service segment possible in an interchange is the 'UNA' segment which defines the service characters being used in the interchange.

The second service segment, 'UNB', indicates the beginning of the interchange.

The next one, 'UNG', indicates the beginning of a group of messages of the same type, or to create own identifiable application level envelope.

The last service segment, 'UNH', indicates the beginning of a given message.

Each beginning service segment corresponds to an ending service segment (note: UNA is not a beginning segment).

- Service string advice: UNA
- Interchange envelope: UNB UNZ
- Group envelope: UNG UNE

- Message envelope: UNH UNT

The interchange can thus be represented like this:

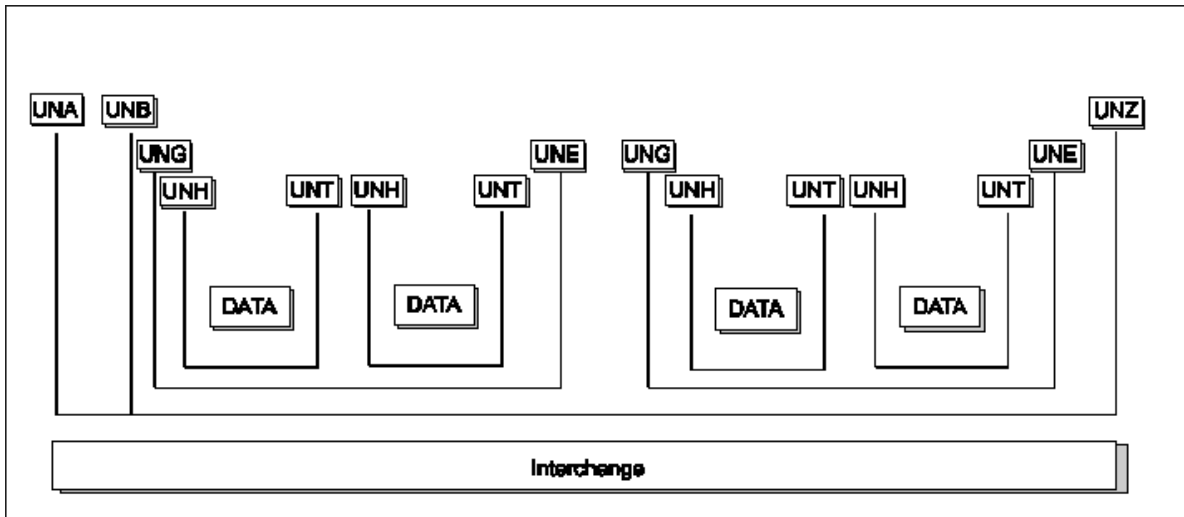

The status of segment UNA is dependent on the character set level and service characters being used. If character set level A is being used together with the default service characters for EANCOM® then the UNA segment is not required. However, should trading partners agree to use any of the character sets level B to F (inclusive) and the default service characters for EANCOM®, then the UNA segment must be sent.

Segments UNB..UNZ and UNH..UNT are mandatory.

Segments UNG..UNE are conditional. Within EANCOM® the use of the UNG..UNE segments should not be used for grouping of multiple message types in the same interchange as this is not considered good practice. However, they can be used by organisations to create their own identifiable application level envelopes, which can be addressed from the originating department to a department in the recipient's system, e.g. to group multiple issuers in one transmission file with invoices.

If the UNG..UNE segments are used, then it should be noted that it is not possible in the EANCOM® CONTRL message to report syntactically on a functional group.

The message itself is structured with a Header, a Detail and a Summary section. In messages where there may be ambiguity between the sections, the UNS segment may be used as a separator.

The layout of the service segments UNA, UNB - UNZ, UNG - UNE, and UNH - UNT- used in EANCOM® is presented in this section. The Section Control Segment (UNS) is not shown here. Its usage is defined in those EANCOM® messages where the segment is actually used.

Segment Layout - UNA segment

UNA - C 1 -		Service String Advice			
Function :		The service string advice shall begin with the upper case characters UNA immediately followed by six characters in the order shown below. The same character shall not be used in more than one position of the UNA.			
Segment number :					
		EDIFACT	GS1	*	Description
UNA1	Component data element separator	M an1	M	*	Used as a separator between component data elements contained within a composite data element (default value: ":")

UNA2	Data element separator	M an1	M	*	Used to separate two simple or composite data elements (default value: "+")
UNA3	Decimal notation	M an1	M	*	Used to indicate the character used for decimal notation (default value: ".")
UNA4	Release character	M an1	M	*	Used to restore any service character to its original specification (value: "?").
UNA5	Reserved for future use	M an1	M	*	(default value: space)
UNA6	Segment terminator	M an1	M	*	Used to indicate the end of segment data (default value: " * ")

Segment Notes:

This segment is used to inform the receiver of the interchange that a set of service string characters which are different to the default characters are being used.

When using the default set of service characters, the UNA segment need not be sent. If it is sent, it must immediately precede the UNB segment and contain the four service string characters (positions UNA1, UNA2, UNA4 and UNA6) selected by the interchange sender.

Regardless of whether or not all of the service string characters are being changed every data element within this segment must be filled, (i.e., if some default values are being used with user defined ones, both the default and user defined values must be specified).

When expressing the service string characters in the UNA segment, it is not necessary to include any element separators.

The use of the UNA segment is required when using a character set other than level A.

Example:

UNA:+.?'

Segment Layout - UNB segment

UNB - M 1 -		Interchange Header			
Function :		To identify an interchange.			
Segment number :		-			
		EDIFACT	GS1	*	Description
S001	SYNTAX IDENTIFIER	M	M		See Part I chapter 5.2.7 and segment notes.
0001	Syntax identifier	M a4	M	*	UNOA = UN/ECE level A UNOB = UN/ECE level B UNOC = UN/ECE level C UNOD = UN/ECE level D UNOE = UN/ECE level E UNOF = UN/ECE level F
0002	Syntax version number	M an1	M	*	3 = Version 3
0080	Service code list directory version number	C an..6	N		
0133	Character encoding, coded	C an..3	N		
S002	INTERCHANGE SENDER	M	M		
0004	Interchange sender identification	M an..35	M		GLN (n13)
0007	Identification code qualifier	C an..4	R	*	14 = GS1

0008	Interchange sender internal identification	C an..35	O		
0042	Interchange sender internal sub-identification	C an..35	N		
S003	INTERCHANGE RECIPIENT	M	M		
0010	Interchange recipient identification	M an..35	M		GLN (n13)
0007	Identification code qualifier	C an..4	R	*	14 = GS1
0014	Interchange recipient internal identification	C an..35	O		
0046	Interchange recipient internal sub-identification	C an..35	N		
S004	DATE AND TIME OF PREPARATION	M	M		
0017	Date	M n8	M		YYMMDD
0019	Time	M n4	M		HHMM
0020	Interchange control reference	M an..14	M		Unique reference identifying the interchange. Created by the interchange sender.
S005	RECIPIENT REFERENCE/ PASSWORD DETAILS	C	O		
0022	Recipient reference/password	M an..14	M		
0025	Recipient reference/password qualifier	C an2	O		
0026	Application reference	C an..14	O		Message identification if the interchange contains only one type of message.
0029	Processing priority code	C a1	O		A = Highest priority
0031	Acknowledgement request	C n1	O		1 = Requested
0032	Interchange agreement identifier	C an..35	O	*	EANCOM.....
0035	Test indicator	C n1	O		1 = Interchange is a test

Segment notes:

This segment is used to envelope the interchange, as well as to identify both, the party to whom the interchange is sent and the party who has sent the interchange. The principle of the UNB segment is the same as a physical envelope which covers one or more letters or documents, and which details, both the address where delivery is to take place and the address from where the envelope has come.

S001: The character encoding specified in basic code table of ISO/IEC 646 (7-bit coded character set for information interchange) shall be used for the interchange service string advice (if used) and up to and including the composite data element S001 'Syntax identifier' in the interchange header. The character repertoire used for the characters in an interchange shall be identified from the code value of data element 0001 in S001 'Syntax identifier' in the interchange header. The character repertoire identified does not apply to objects and/or encrypted data.

The default encoding technique for a particular repertoire shall be the encoding technique defined by its associated character set specification.

DE 0001: The recommended (default) character set for use in EANCOM® for international exchanges is character set A (UNOA). Should users wish to use character sets other than A, an agreement on which set to use should be reached on a bilateral basis before communications begin.

DE 0004, 0008, 0010, 0014, 0042 and 0046: Within EANCOM® the use of the Global Location Number (GLN) is recommended for the identification of the interchange sender and recipient.

DE 0008: Identification (e.g. a division) specified by the sender of the interchange, to be included if agreed, by the recipient in response interchanges, to facilitate internal routing.

DE 0042: Sub-level of sender internal identification, when further sub-level identification is required.

DE 0014: The address for routing, provided beforehand by the interchange recipient, is used by the interchange sender to inform the recipient of the internal address, within the latter's systems, to which the interchange should be routed. It is recommended that the GLN be used for this purpose.

DE 0007: Identification (e.g. a division) specified by the recipient of the interchange, to be included if agreed, by the sender in response interchanges, to facilitate internal routing.

DE 0046: Sub-level of recipient internal identification, when further sub-level identification is required.

DE S004: The date and time specified in this composite should be the date and time at which the interchange sender prepared the interchange. This date and time may not necessarily be the same as the date and time of contained messages.

DE 0020: The interchange control reference number is generated by the interchange sender and is used to identify uniquely each interchange. Should the interchange sender wish to re-use interchange control reference numbers, it is recommended that each number be preserved for at least a period of three months before being re-used. In order to guarantee uniqueness, the interchange control reference number should always be linked to the interchange sender's identification (DE 0004).

DE S005: The use of passwords must first be agreed bilaterally by the parties exchanging the interchange.

DE 0026: This data element is used to identify the application, on the interchange recipient's system, to which the interchange is directed. This data element may only be used if the interchange contains only one type of message, (e.g. only invoices). The reference used in this data element is assigned by the interchange sender.

DE 0031: This data element is used to indicate whether an acknowledgement to the interchange is required. The EANCOM® APERAK or CONTRL message should be used to provide acknowledgement of interchange receipt. In addition, the EANCOM® CONTRL message may be used to indicate when an interchange has been rejected due to syntax errors.

DE 0032: This data element is used to identify any underlying agreements which control the exchange of data. Within EANCOM®, the identity of such agreements must start with the letters 'EANCOM', the remaining characters within the data element being filled according to bilateral agreements.

Example:

UNB+UNOA:3+5412345678908:14+8798765432106:14+020102:1000+12345555++++EANCOMREF 52'

Segment Layout - UNG segment

UNG - C 1 -		Functional Group Header			
Function :		To start, identify and specify a functional group.			
Segment number :					
		EDIFACT	GS1	*	Description
0038	FUNCTIONAL GROUP IDENTIFICATION	M an..6	M		Identification of a message contained in the functional group, e.g. INVOIC.
S006	APPLICATION SENDER'S IDENTIFICATION	M	M		
0040	Sender identification	M an..35	M		GLN (n13)
0007	Identification code qualifier	C an..4	R	*	14 = GS1
S007	INTERCHANGE RECIPIENT	M	M		
0044	Recipient identification	M an..35	M		GLN (n13)
0007	Identification code qualifier	C an..4	R	*	14 = GS1
S004	DATE / TIME OF PREPARATION	M	M		
0017	Date	M n6	M		YYMMDD
0019	Time	M n4	M		HHMM
0048	Functional group reference number	M an..14	M		Unique reference identifying the functional group. Created by the interchange sender.
0051	Controlling agency	M an..2	M	*	UN = UN/CEFACT
S008	MESSAGE VERSION	M	M		
0052	Message type version number	M an..3	M	*	D = UN/EDIFACT directory
0054	Message type release number	M an..3	M		The value of this data element depends on the message type.
0057	Association assigned code	C an..6	R		The value of this data element depends on the message type.
0058	Application password	C an..14	D		The use of this data element depends on agreements between the trading partners.
Segment notes:					
<p>Within EANCOM® the use of the UNG..UNE segments should not be used for grouping of multiple message types in the same interchange as this is not considered good practice. However, they can be used by organisations to create their own identifiable application level envelopes, which can be addressed from the originating department to a department in the recipient's system, e.g. to group multiple issuers in one transmission file with invoices.</p>					
Example:					
UNG+INVOIC+5412345678908:14+8798765432106:14+020102:1000+471123+UN+D:01B:EAN010'					

Segment Layout - UNH segment

UNH - M 1 -		MESSAGE HEADER			
Function :		To head, identify and specify a message.			
Segment number :		-			
		EDIFACT	GS1	*	Description
0062	Message reference number	M an..14	M		Unique reference number assigned to a message within an interchange by the sender. Same reference number as in DE 0062 of the UNT segment of the message.
S009	MESSAGE IDENTIFIER	M	M		
0065	Message type	M an..6	M	*	Identification of a message.
0052	Message version number	M an..3	M	*	D = UN/EDIFACT Directory
0054	Message release number	M an..3	M	*	01B = Release 2001 - B
0051	Controlling agency	M an..2	M	*	UN = UN/CEFACT
0057	Association assigned code	C an..6	R	*	EANnnn = EANCOM® subset version. EAN represents GS1. 'nnn' is the subset version number of the EANCOM® message.
0110	Code list directory version number	C an..6	O		E4yyyy = EANCOM® code list version number. 'E' represents GS1. '4' stands for ISO 9735–Syntax version 4. 'yyyy' is the year of publication.
0113	Message type sub-function identification	C an..6	N		
0068	Common access reference	C an..35	N		
S010	STATUS OF THE TRANSFER	C	N		
0070	Sequence of transfers	M n..2			
0073	First and last transfer	C a1			
S016	MESSAGE SUBSET IDENTIFICATION	C	N		
0115	Message subset identification	M an..14			
0116	Message subset version number	C an..3			
0118	Message subset release number	C an..3			
0051	Controlling agency, coded	C an..3			
S017	MESSAGE IMPLEMENTATION GUIDELINE IDENTIFICATION	C	N		
0121	Message implementation guideline identification	M an..14			

0122	Message implementation guideline version number	C an..3			
0124	Message implementation guideline release number	C an..3			
0051	Controlling agency, coded	C an..3			
S018	SCENARIO IDENTIFICATION	C	N		
0127	Scenario identification	M an..14			
0128	Scenario version number	C an..3			
0130	Scenario release number	C an..3			
0051	Controlling agency, coded	C an..3			
<p>Segment Notes:</p> <p>This segment is used to head and uniquely identify a message in an interchange.</p> <p>DE 0062: It is good practice to have the message reference number both unique and incremental.</p> <p>S009: Identification of an EANCOM® message.</p> <p>The content of data elements 0065, 0052, 0054 and 0051 must be taken from the related UN/EDIFACT standard message.</p> <p>The content of data element 0057 is assigned by GS1 as part of the EANCOM® maintenance process.</p> <p>DE 0065: Data element 0065 identifies a UN/EDIFACT message whereas the exact usage of the message is specified in BGM data element 1001. E.g. UN/EDIFACT invoice message serving as a credit note: UNH DE 0065 = INVOIC, BGM DE 1001 = 381.</p> <p>DE 0110: This data element can be used by the trading partners to identify an EANCOM® code list, different from the code list published as an integral part of EANCOM® syntax version 4, 2002 release, they have mutually agreed to use when interchanging a message.</p> <p>The combination of the values carried in the data elements 0062 and S009 shall be used to uniquely identify the message within the interchange for the purpose of acknowledgement (ref. UNB – data element 0031).</p> <p>Example:</p> <p>UNH+1+INVOIC:D:01B:UN:EAN010'</p>					

Segment Layout - UNT segment

UNT - M 1 -		MESSAGE TRAILER			
Function :		To end and check the completeness of a message.			
Segment number :					
		EDIFACT	GS1	*	Description
0074	Number of segments in the message	M n..10	M		Total number of segments in a message.
0062	Message reference number	M an..14	M		Same reference number as in DE 0062 of the UNH segment of the message.
<p>Segment Notes:</p> <p>This segment is used to end and provide information for checking the completeness of a message.</p> <p>The segment number shows the position of the segment in a message. It must always be the last segment in a message.</p> <p>DE 0074: Count of all segments in a message, UNH and UNT included.</p> <p>Example:</p> <p>UNT+103+1'</p>					

Segment Layout - UNE segment

UNE - C 1 -		FUNCTIONAL GROUP TRAILER			
Function :		To end and check the completeness of a functional group.			
Segment number :					
		EDIFACT	GS1	*	Description
0060	Number of messages	M n..6	M		Number of messages in the group.
0048	Functional group reference number	M an..14	M		Identical to DE 0048 in UNG segment.
<p>Segment Notes:</p> <p>Within EANCOM® the use of the UNG..UNE segments should not be used for grouping of multiple message types in the same interchange as this is not considered good practice. However, they can be used by organisations to create their own identifiable application level envelopes, which can be addressed from the originating department to a department in the recipient's system, e.g. to group multiple issuers in one transmission file with invoices.</p> <p>Example:</p> <p>UNE+25+471123'</p>					

Segment Layout - UNZ segment

UNZ - M 1 -		INTERCHANGE TRAILER			
Function :		To end and check the completeness of an interchange.			
Segment number :					
		EDIFACT	GS1	*	Description
0036	Interchange control count	M n..6	M		Number of messages or functional groups within an interchange.
0020	Interchange control reference	M an..14	M		Identical to DE 0020 in UNB segment.
<p>Segment Notes:</p> <p>This segment is used to provide the trailer of an interchange.</p> <p>DE 0036: If functional groups are used, this is the number of functional groups within the interchange. If functional groups are not used, this is the number of messages within the interchange.</p> <p>Example:</p> <p>UNZ+5+12345555'</p>					

Example of an interchange:

An interchange contains two sets of messages: three Despatch Advices and two Invoices. The interchange is sent on 2 January 2002 by a company identified by the GLN 5412345678908 to a company identified by the GLN 8798765432106.

```
UNB+UNOA:3+5412345678908:14+8798765432106:14+020102:1000+12345555+++++EANCOMRE
F52'
```

```
....
UNH+66025+DESADV:D:01B:UN:EAN007'
....
....
UNT+35+66025'
UNH+66420+DESADV:D:01B:UN:EAN007'
....
....
```

UNT+26+66420'
 UNH+1588+INVOIC:D:01B:UN:EAN010'

 UNT+46+1588'
 UNH+2063+INVOIC:D:01B:UN:EAN010'

 UNT+87+2063'
 UNH+67020+DESADV:D:01B:UN:EAN007'

 UNT+102+67020'

 UNZ+5+12345555'

7. APPENDIX 2: GLOSSARY OF EDI TERMINOLOGY

Term	Definition
Character set	A finite set of different characters that is considered complete for a given purpose.
Code	<p>a. A character string used as an abbreviated means of recording or identifying information.</p> <p>b. To represent or identify information using a specific symbolic form that can be recognised by a computer.</p>
Component data element	A simple data element used within a composite data element.
Component data element separator	A service character used to separate component data elements in a composite data element.
Composite data element	A data element containing two or more functionally related component data elements.
Conditional	A statement in a segment or message directory of a condition for the use of a segment, a data element, a composite data element, or a component data element.
Data	A representation of facts, concepts or instructions in a formalised manner suitable for communication, interpretation or processing by human beings or by automatic means.
Data element	A unit of data for which the identification, description and value representation have been specified.
Data element name	One or more words in a natural language identifying a data element concept.
Data element separator	A service character used to separate data elements in a segment.
Data element tag	A unique identifier for a data element in a data element directory.
Data element value	The specific entry of an identified data element represented as specified in a data element directory.
Data element representation	The format (e.g. numeric, alphabetic, variable length etc.) of a data item.

Term	Definition
EDIFACT	Electronic Data Interchange for Administration, Commerce and Transport.
Explicit representation	The technique used to give an absolute identification of the location of a data segment within a message.
Functional group	One or more messages of the same type headed by a functional group header service segment and ending with a functional group trailer service segment.
Functional group header	The service segment heading and identifying the functional group.
Functional group trailer	The service segment ending a functional group.
Group of segments	Identified, usually repeatable, grouping of segments.
Header section	The portion of the message which precedes the actual body and trailer of the business transaction, and which contains information which relates to the entire message.
Identifier	A character or group of characters used to identify or name an item of data and possibly to indicate certain properties of that data.
Implementation guideline (EANCOM®)	A UNSM sub-set provided with detailed usage notes, clear guidance what to do and when to do, strict rules for the usage of GS1 numbering standards, relevant codes only, more precise definitions of data and codes and business situation examples.
Interchange	Communication between partners in the form of a structured set of messages and service segments starting with an interchange control header and ending with an interchange control trailer.
Interchange agreement	Document, usually in the form of a user manual, which describes, e.g., level of syntax, messages, legal and security requirements etc.
Level	Relative hierarchical position of a data segment within a message.
Mandatory	A statement in a segment or message directory which specifies that a segment, a data element, a composite data element or a component data element must be used.
Message	A set of segments in the order specified in a message directory starting with the message header and ending with the message trailer.
Message diagram	A graphic representation of the sequence of segments within a message.
Message header	The service segment starting and uniquely identifying a message.
Message trailer	The service segment ending a message.
Message type	An identified and structured set of data elements covering the requirements for a specified type of transaction, e.g. invoice.
Nested segment	A segment which directly relates to another segment in an identified and structured group of segments covering the requirements for a specific message type.
Omission	Exclusion in an actual message of one or more units of data which are defined as conditional in a message type specification.

Term	Definition
Qualified data element	A data element whose precise meaning is conveyed by an associated qualifier.
Qualifier	A data element whose value shall be expressed as a code that gives specific meaning to the function of another data element or a segment.
Release character	A service character used to restore to its original meaning any character used as a service separator.
Section control segment	A service segment used to separate header, detail and summary sections of a message where necessary to avoid ambiguities in the message segment content.
Segment	A pre-defined and identified set of functionally related data elements values which are identified by their sequential positions within the set. A segment starts with a segment tag and ends with a segment terminator. It can be a service segment or a user data segment.
Segment code	A code which uniquely identifies each segment as specified in a segment directory.
Segment directory	A listing of identified, named, described and specified segments.
Segment name	One or more words in a natural language identifying a data segment concept.
Segment number (EANCOM®)	Numeric value used to show the position of a segment in an EANCOM® message, starting at 1 for the first segment.
Segment tag	A composite data element in which the first component data element contains a code which uniquely identifies a segment as specified in the relevant segment directory. Additional component data elements can be conditionally used to indicate the hierarchical level and nesting relation in a message and the incidence of repetition of the segment.
Segment terminator	A service character indicating the end of a segment.
Service character	A character reserved for syntactical use.
Service data element	A data element used in service segments.
Service segment	A segment required to service the interchange of user data.
Service string advice	A character string at the beginning of an interchange defining syntactically delimiting characters and indicators used in the interchange.
Simple data element	A data element containing a single data element value.
Status	Indication whether a segment group, segment, composite data element or data element item is mandatory (M) or conditional (C) in the application concerned.
Summary section	The portion of the message which follows the body of the message and which contains summary information relating to the entire message.
Syntax rules	Rules governing the structure of an interchange and its functional groups, messages, segments and data elements.
Tag	A unique identifier for a segment or data element.
Trading partners	The sending and/or receiving parties involved in exchanging electronic business messages.

Term	Definition
UN/EDIFACT	United Nations/Electronic Data Interchange for Administration, Commerce and Transport.
UNSM	<p>United Nations Standard Message, an EDIFACT message type approved for international use. A UNSM is a message which:</p> <ul style="list-style-type: none"> I. has been registered, published and which is maintained by the United Nations Economic Commission for Europe; II. has the values contained in the Controlling Agency, Message Type, Message Version Number and Message Release Number fields (the requirements for the use of which are specified in ISO 9735), allocated and controlled by the UN/ECE; III. always has the code value "UN" in the Controlling Agency field.
UNSM Sub-set	<p>A sub-set of a UNSM is a message which is directly derived from an approved UNSM, has the same function as the UNSM from which it is derived, and which:</p> <ul style="list-style-type: none"> I. contains all of the groups and segments defined as having a mandatory status within the message, and the mandatory data elements within them. There shall be no change to the status, order or content of the groups, segments and composite data elements and data elements contained within the segments. (It should be noted, however, that although many UNSMs contain Conditional Groups of segments which may contain one or more mandatory segments, providing the complete conditional group is omitted from the sub-set, this does not break the rule regarding the inclusion of mandatory segments); II. does not change the status, order or content of the Segments, composite data elements and data elements in the conditional segments chosen for use from the UNSM. III. does not add any segments, composite data elements or data elements to the message; IV. contains the identical values specified for use in the Message Type, Controlling Agency, Message Version Number and Message Release Number fields, as are specified for the UNSM from which the sub-set is derived
User data segment	A segment containing application data.