

NSW HEALTH

Product Catalogue & eProcurement

October 2013

Valentino Bulaon
Manager, Procurement & Catalogue Information
Business Procurement Services



HealthShare

SCOPE OF PRESENTATION

- Australia & the State of New South Wales at a Glance
- NSW Health & Shared Corporate Services
- The National Product Catalogue
- NSW Health State Systems & State Catalogue
- Data Structure – Master Catalogue Concept
- E-Procurement Solution & Data Convergence
- Ongoing & Next Strategies

AUSTRALIA & NSW AT A GLANCE

- 6th Largest Country (land size)
- 22.8 M people 64% in capital cities
- 8 States & Territories
- Health Expenditure 9.1% GDP (103 B)



- Largest & Most populous 7.2M (34.5% of total)
- Almost 2x size of CA
- 62.9% based in Sydney
- Economically most important state

NSW HEALTH

- Ministry of Health
- Admitted Patient Services
 - Local Health Districts (15)
 - Health Networks (Children's & Forensic Mental Health)
 - 2.4M Hospitalisation (2010/11) – 67% Public
 - 220+ Public Hospitals
- Shared Corporate Services
 - HealthShare NSW – 800 million annual budget
 - Largest Public Sector Shared Services
 - 6K employees



SHARED CORPORATE SERVICES

HEALTHSHARE NSW

Tendering Contracting Procurement & Logistics

- Business Procurement Services
- Service Centres
- Distribution Centres
- Largest Healthcare Buyer
- 63K PO per month
- 200K+ Catalogued Items

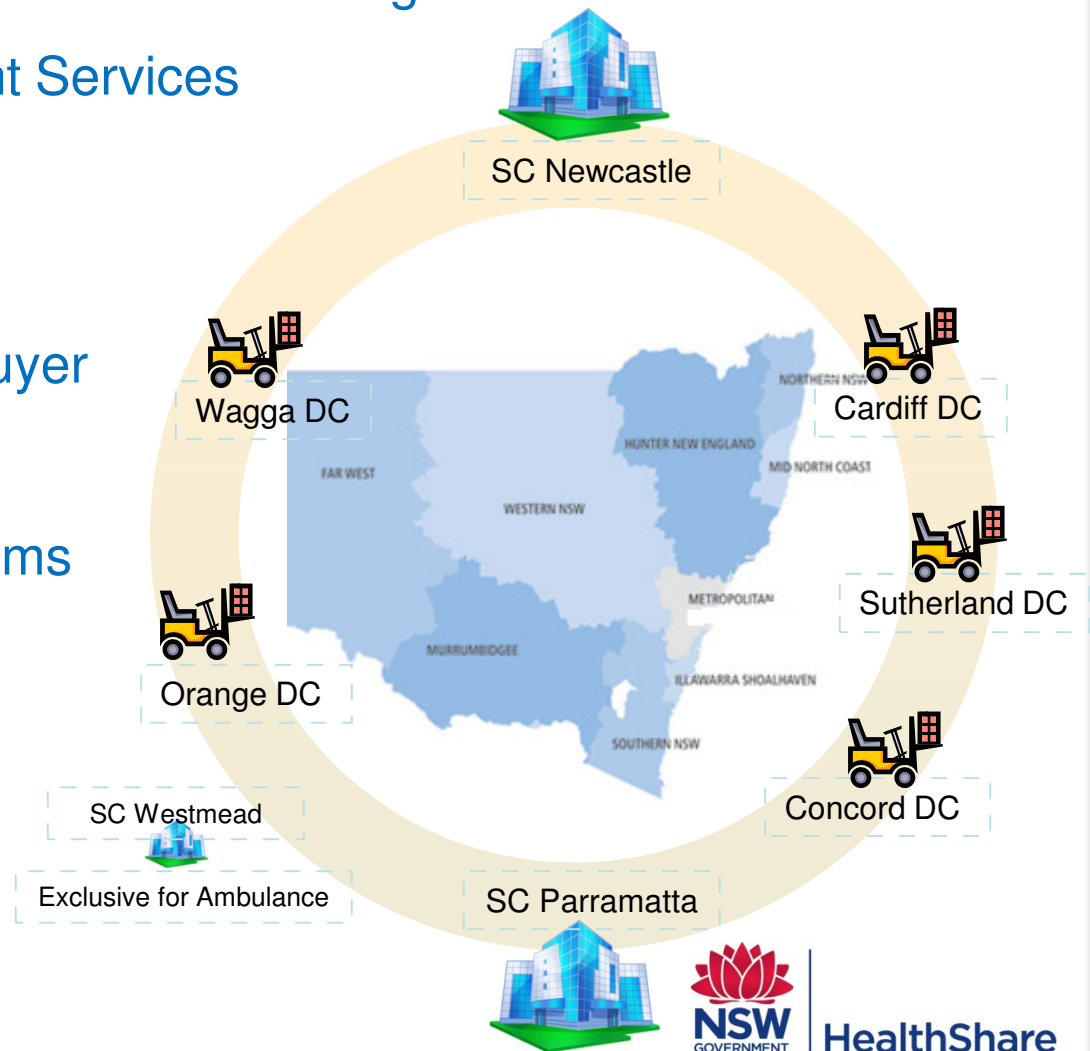

NATIONAL PRODUCT CATALOGUE (NPC)

- A GDSN Data Pool / Compliant
- Promotes Data Synchronisation in line with Global Standards
- Ensures Standardise Accurate Product & Price Data for eProcurement
- A Single Mechanism to Many
- 302K+ GTINS
- 390+ Suppliers
- All State Access
- Private Sector
- NeHTA estimates 200M annual savings

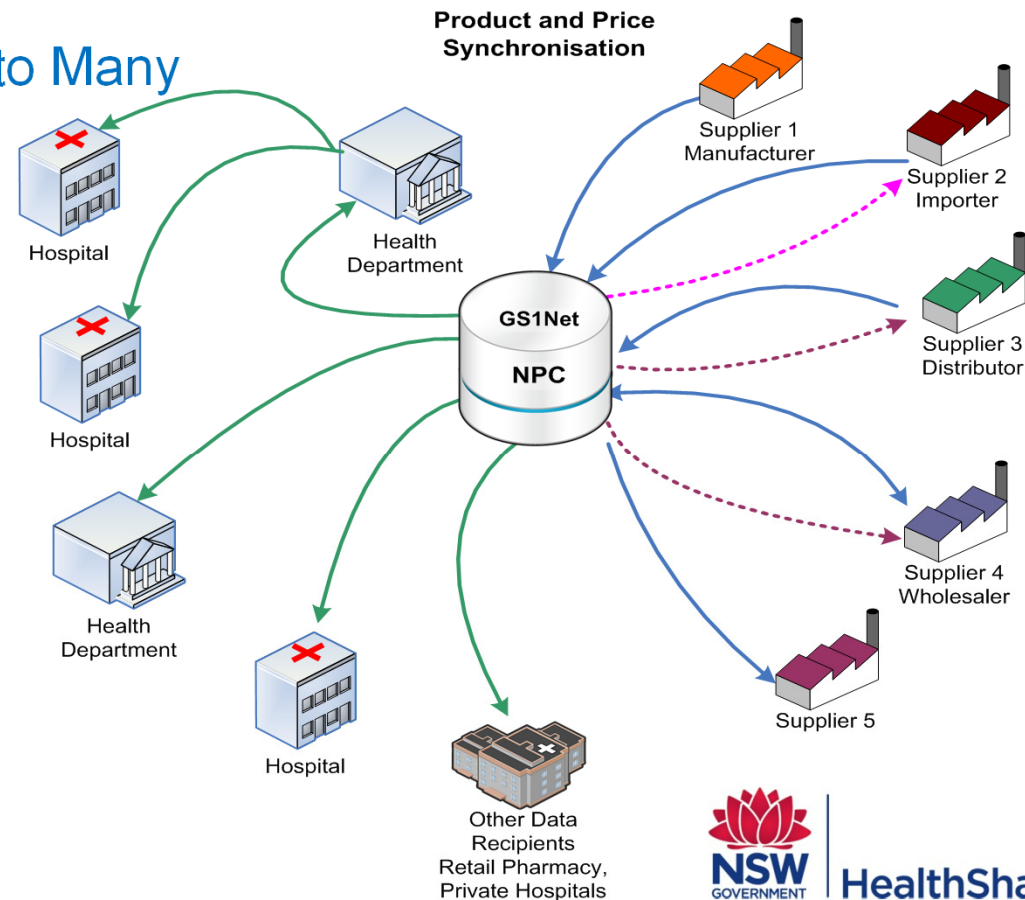

NPC DATA UTILISATION

NSW PROCUREMENT RPOCESSES

Effective Date
 Functional Name
 GLN of Information Provider
 GTIN
 Product Depth
 Product Depth UOM
 Product Gross Weight
 Product Gross Weight UOM
 Product Height
 Product Height UOM
 Product Packaging Marked as Returnable
 Product Width
 Product Width UOM
 Publication Date
 Short Description
 Start Availability
 Target Market Country Code
 Tax Agency Code
 Tax Rate
 Tax Type Code
 Tax Type Description
 Trade Item Description
 Trade Item Group Description
 Trade Item Group ID
 Trade Item Hierarchy Level
 Distribution Method
 Effective Start Date
 Effective Start Date Context
 GLN of Recipient
 Last Change Date / Time:
 Price Action Code
 Price Application Sequence
 Price Basis Quantity
 Price Basis Quantity / UOM
 Price Type
 Price Type ID
 Price Value
 Price Value Type
 Reason for Price Action

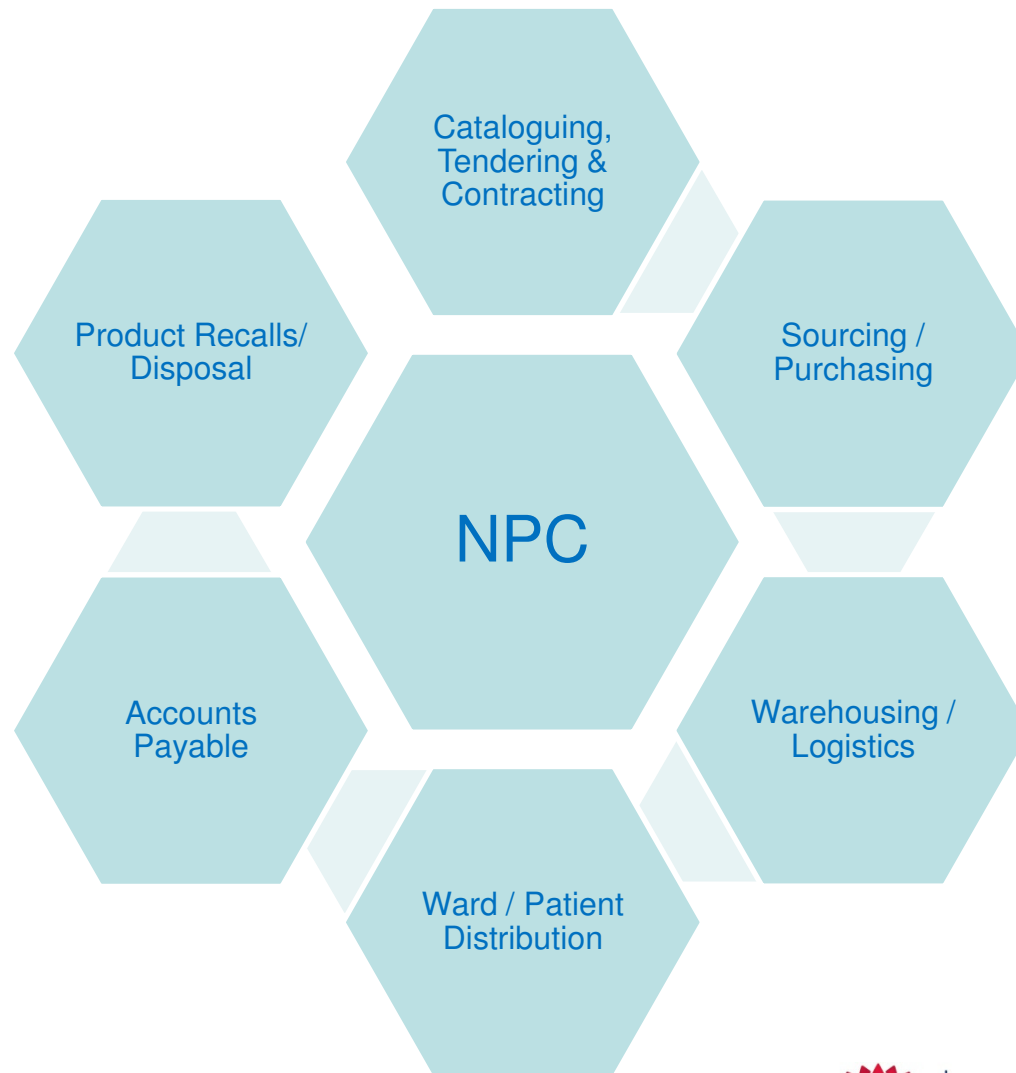

STATE SYSTEMS & CATALOGUE

IMPACT TO HEALTHCARE



Impact of Erroneous Data in Healthcare

- Patient Safety
- Wrong / delayed deliveries
- Wrong invoices – Invoices on Hold
- Re-processing of data
- Manual Tasks Consuming Clinicians Time

EDI

B2B

- eMessages
- PO
 - ASN
 - Invoice
 - EFT
 - GLN
 - GTIN
 - Other

DATA STRUCTURE

MASTER CATALOGUE CONCEPT

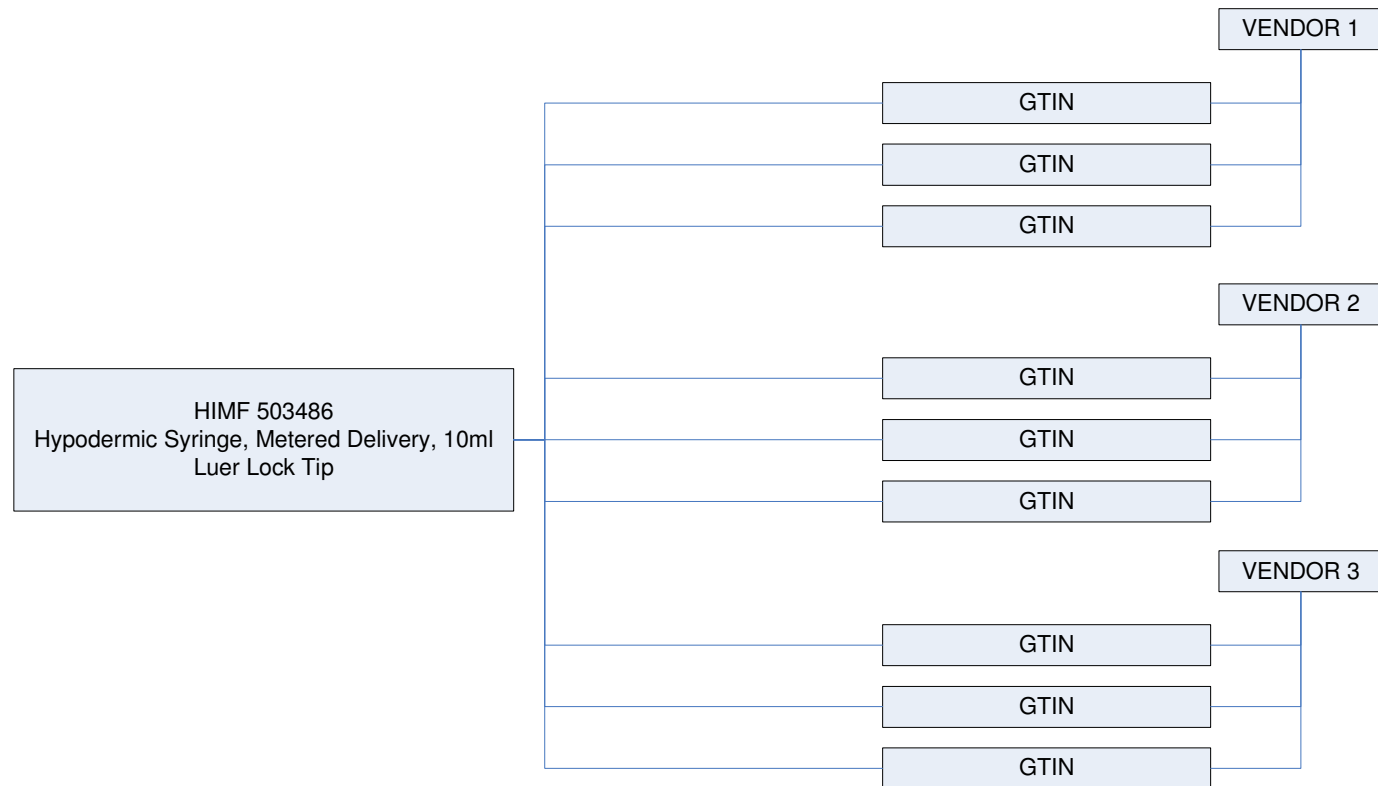

Master Catalogue

- Generic Product Descriptions
- Standard Nomenclatures (GMDN)
- Exceptions where required
- UNSPSC Ver 15.12
- State Chart of Accounts
- Australian Medicines Terminology

E-PROCUREMENT SOLUTION

NPC KEY TO STANDARD DATA

GTIN - Shared identifier across all parties

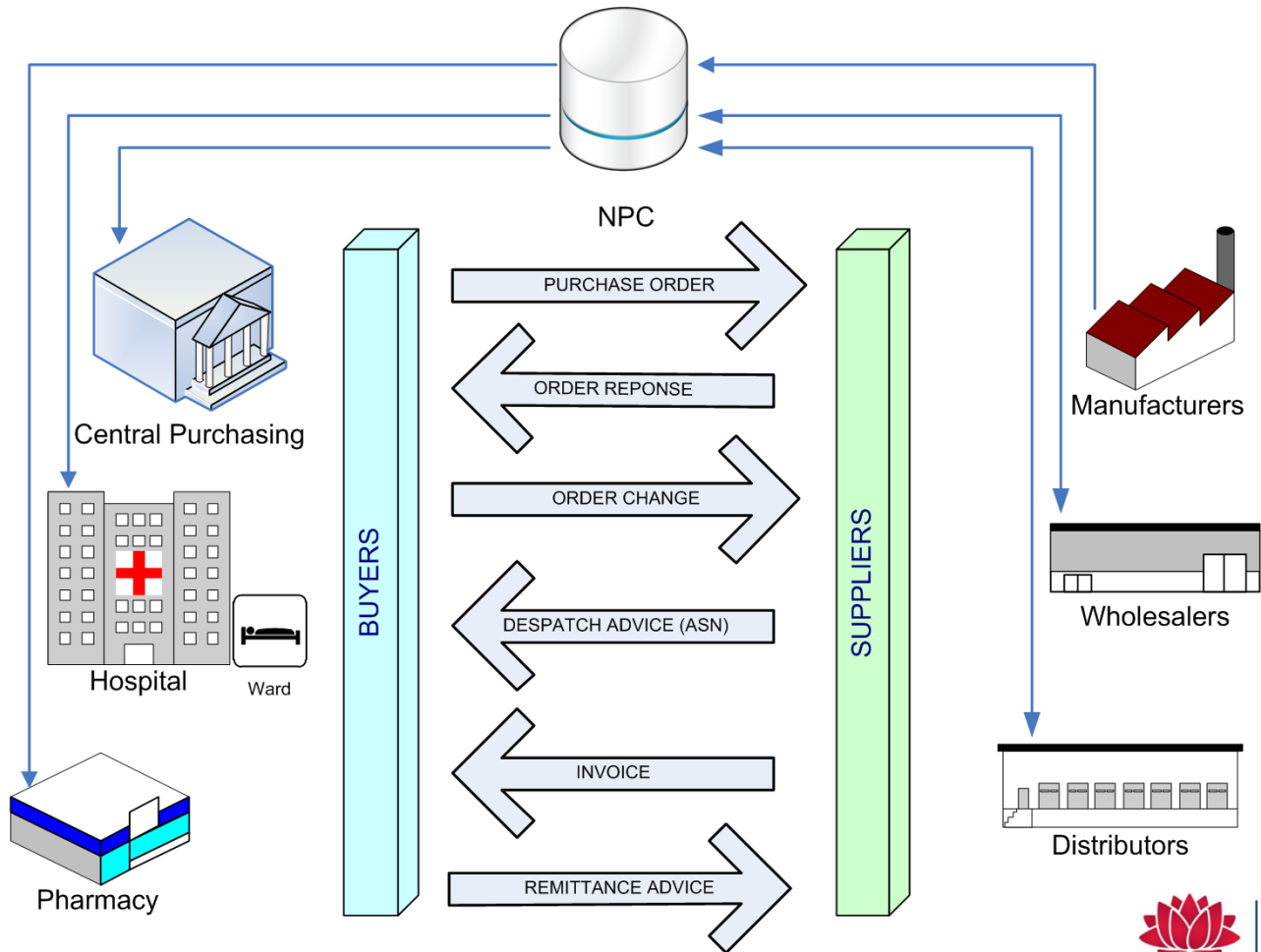

PROCUREMENT DATA CONVERGENCE

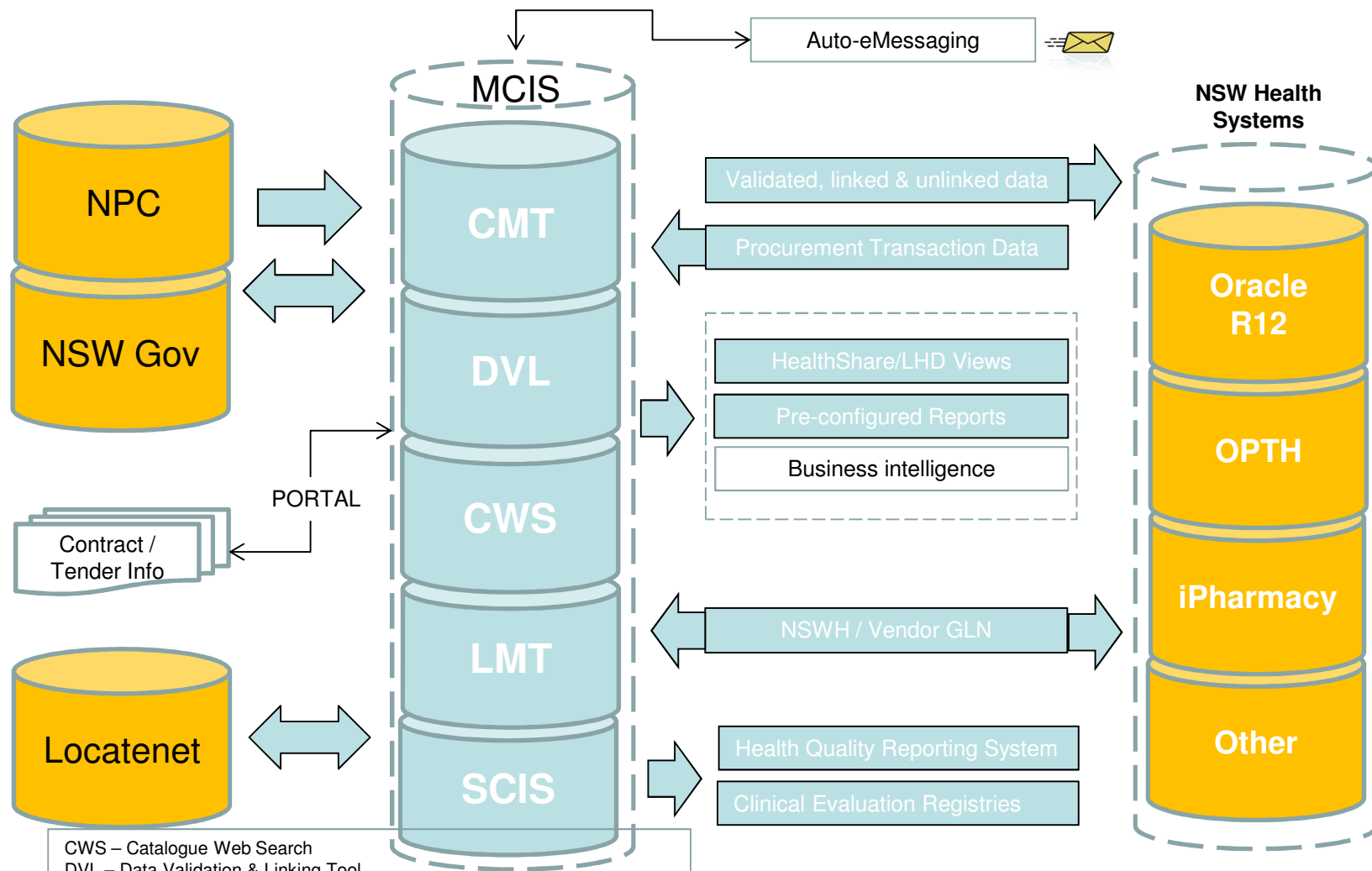

CWS – Catalogue Web Search
 DVL – Data Validation & Linking Tool
 GLN – Global Location Number
 LMT – Location Management Tool
 MCIS – Master Catalogue Information System
 NPC – National Product Catalogue
 OPTH – Operating Theatre Systems, e.g. SurgiNet, MaQs & hTrak
 SCIS – Supply Chain Information System

ONGOING STRATEGY: PROMOTING DATA SYNCHRONISATION

- Shared Compliance Monitoring Table
- LHD On-site Presentation / Education Program
- Supplier Workshops - System Walk Through
- Collaboration
 - Other States & Territories Health Departments
 - Solution Providers
- Partnerships
 - NeHTA
 - GS1 Australia

NEXT STRATEGY: NPC TO SPECIALISED SYSTEMS

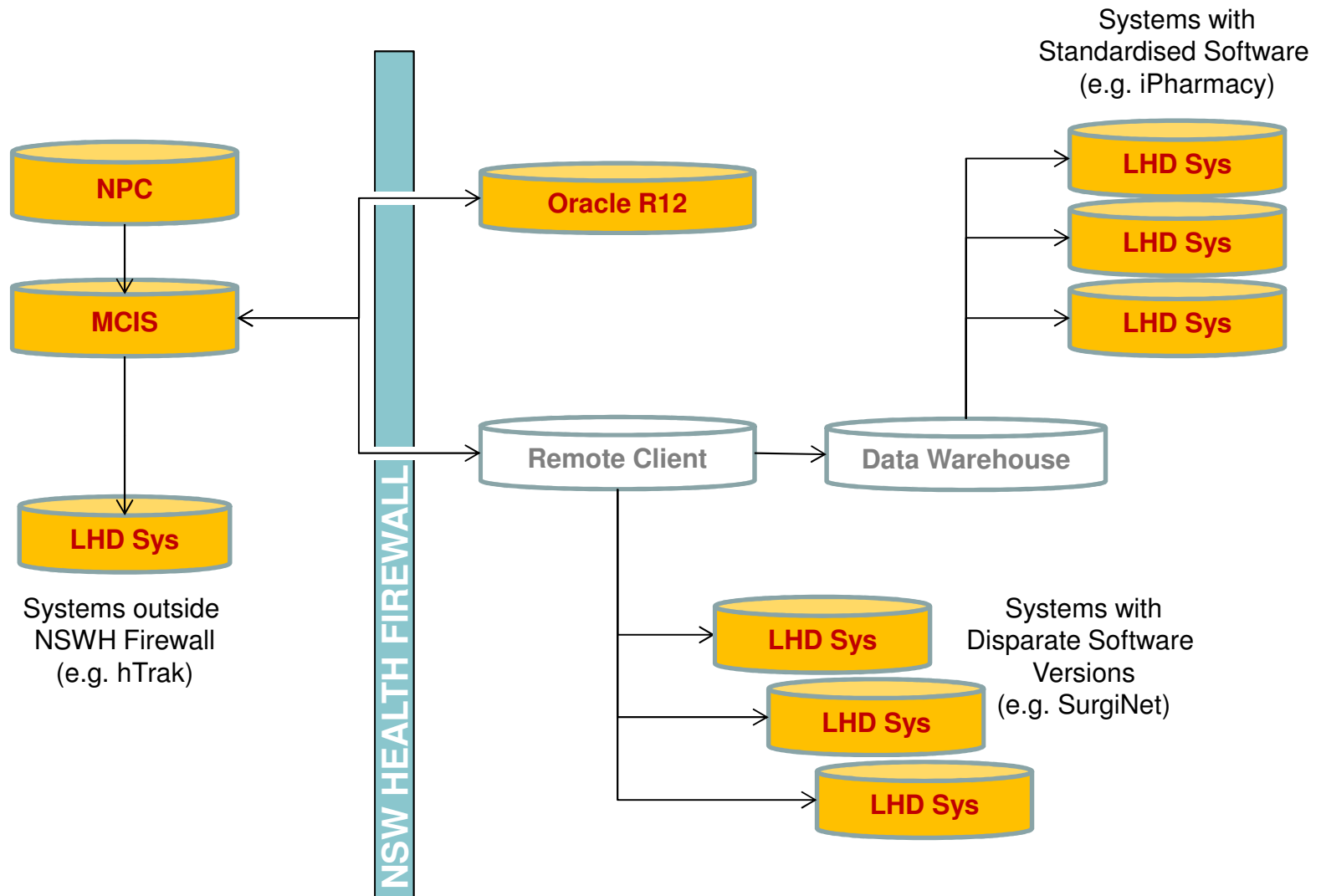

Q&A CONTACT DETAILS

npc@hss.health.nsw.gov.au

cdmt@hss.health.nsw.gov.au

Valentino Bulaon
Manager, Procurement & Catalogue Information
Business Procurement Services